



# HOME POWER

THE HANDS-ON JOURNAL OF HOME-MADE POWER

ISSUE #94 April / May 2003

\$6.95 U.S. \$10.95 CAN.

Display until  
June 1

## Solar at the Capitol Hot Water How-To

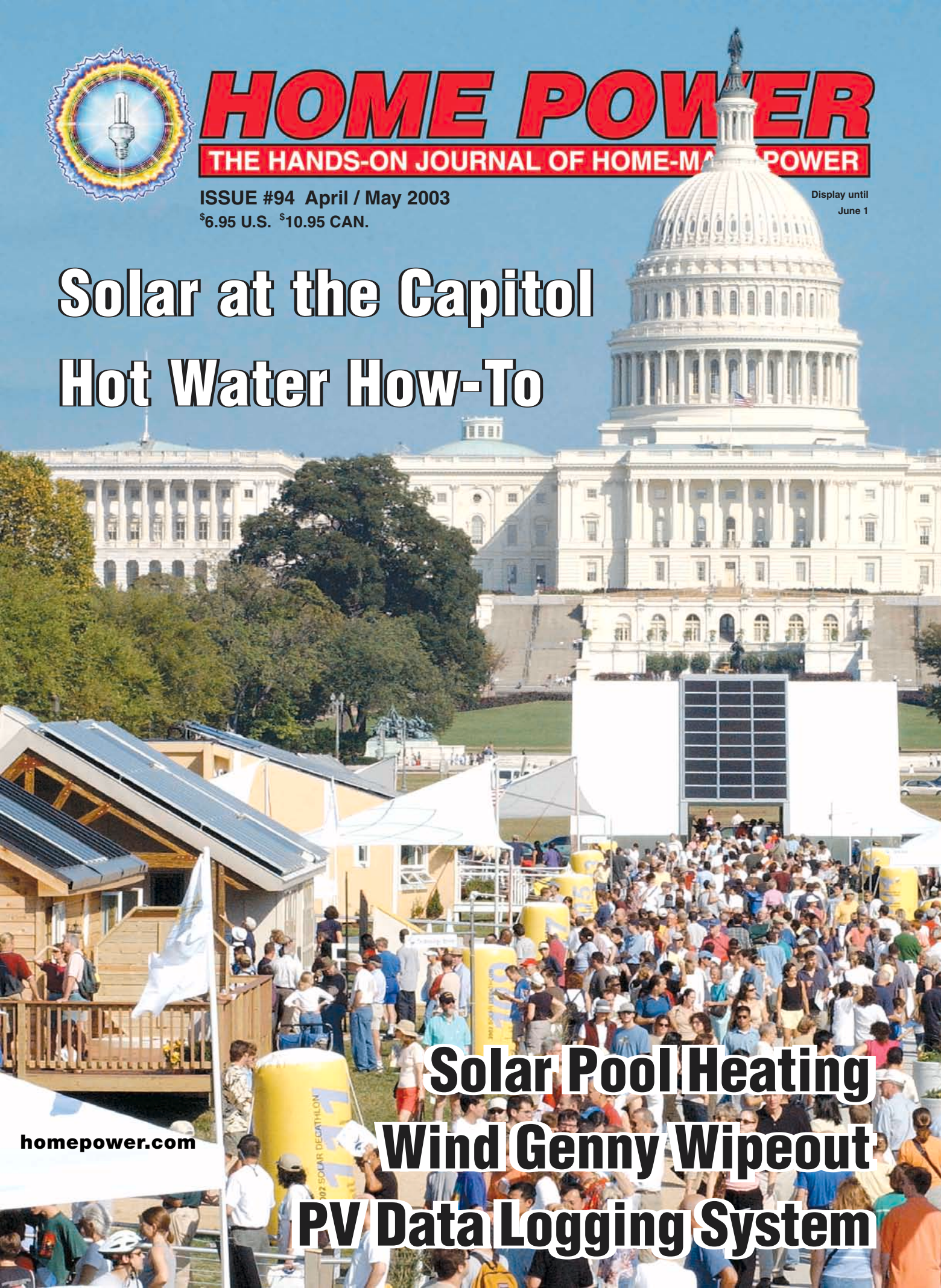

homepower.com

## Solar Pool Heating Wind Genny Wipeout PV Data Logging System

# UTILITY INTER-TIE EXPERTS 23 YEARS PV EXPERIENCE



QUALITY PRODUCTS  
TECHNICAL SUPPORT  
HUGE INVENTORY  
ON-LINE CATALOG  
ON-LINE ORDERING  
STAFF ENGINEERS  
SYSTEM DESIGN

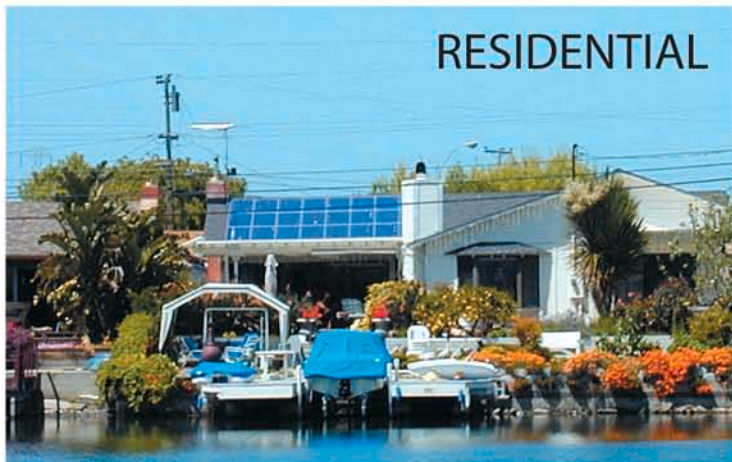

## RESIDENTIAL



## COMMERCIAL



Distributor



AUTHORIZED DISTRIBUTOR



A XANTREX Brand  
AUTHORIZED DISTRIBUTOR

Our packaged systems are thought out and time tested. Easy to set-up, code compliant and complete with everything you need for a functional system. All system components are code compliant and all required approvals to qualify for California Cash Rebates. We offer owner/builder discounts. Dealer inquiries welcome.

### OUR NEW ADDRESS

**SOLAR DEPOT - PETALUMA**  
1240 HOLM ROAD  
PETALUMA, CA 94953  
707.766.7727  
FAX 707.766.7722  
ORDER LINE 800.822.4041

**SOLAR DEPOT - SACRAMENTO**  
8605 FOLSOM BLVD.  
SACRAMENTO, CA 95826  
916.381.0235  
FAX 916.381.2603  
ORDER LINE 800.321.0101

**SOLAR DEPOT SOCAL**  
1520-H COMMERCE STREET  
CORONA, CA 92880  
909.737.7652  
FAX 909.737.7630  
ORDER LINE 800.680.7922



# WWW.SOLARDEPOT.COM

Smart choice for power

xantrex

# Thumbs Up for the New SW Plus Inverter/Charger

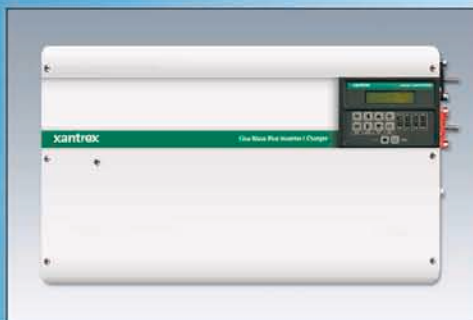

**"We're very happy with the design improvements in the next generation SW inverter. These improvements make installation more convenient and programming more user friendly."**

Richard Perez  
Home Power Magazine

**"The unit has been working flawlessly since installation. We have had no problem running our washer, microwave and espresso maker simultaneously. As a general rule, we have one to three PCs running in the house at the same time without a hitch. It just hasn't had any problems running any loads we've demanded of it."**

Debra Robertson  
Renewable Energy Development Institute

How is it possible to improve on the legendary SW Series inverter/charger? First we talked to our customers who told us what they were looking for. Then we started building on the proven platform of the most reputable inverter/charger in the industry. Finally, we field tested our new SW for 35,000 hours and asked industry leaders for feedback.

The results are in and by all accounts, the new Xantrex SW Plus 2500 kW Inverter/Charger outperforms all other products in its class. With four times surge capacity and 95% peak efficiency, this 2.5 kW inverter is second to none. Add non-volatile memory to save customized settings, and FCC Part B and we're ready to launch the next generation of sine wave power.

For more information about the Xantrex SW Plus 2.5 kW Inverter/Charger, talk to a Xantrex Certified Dealer. You'll find a complete list at [www.xantrexredealer.com](http://www.xantrexredealer.com)



[www.xantrex.com](http://www.xantrex.com)

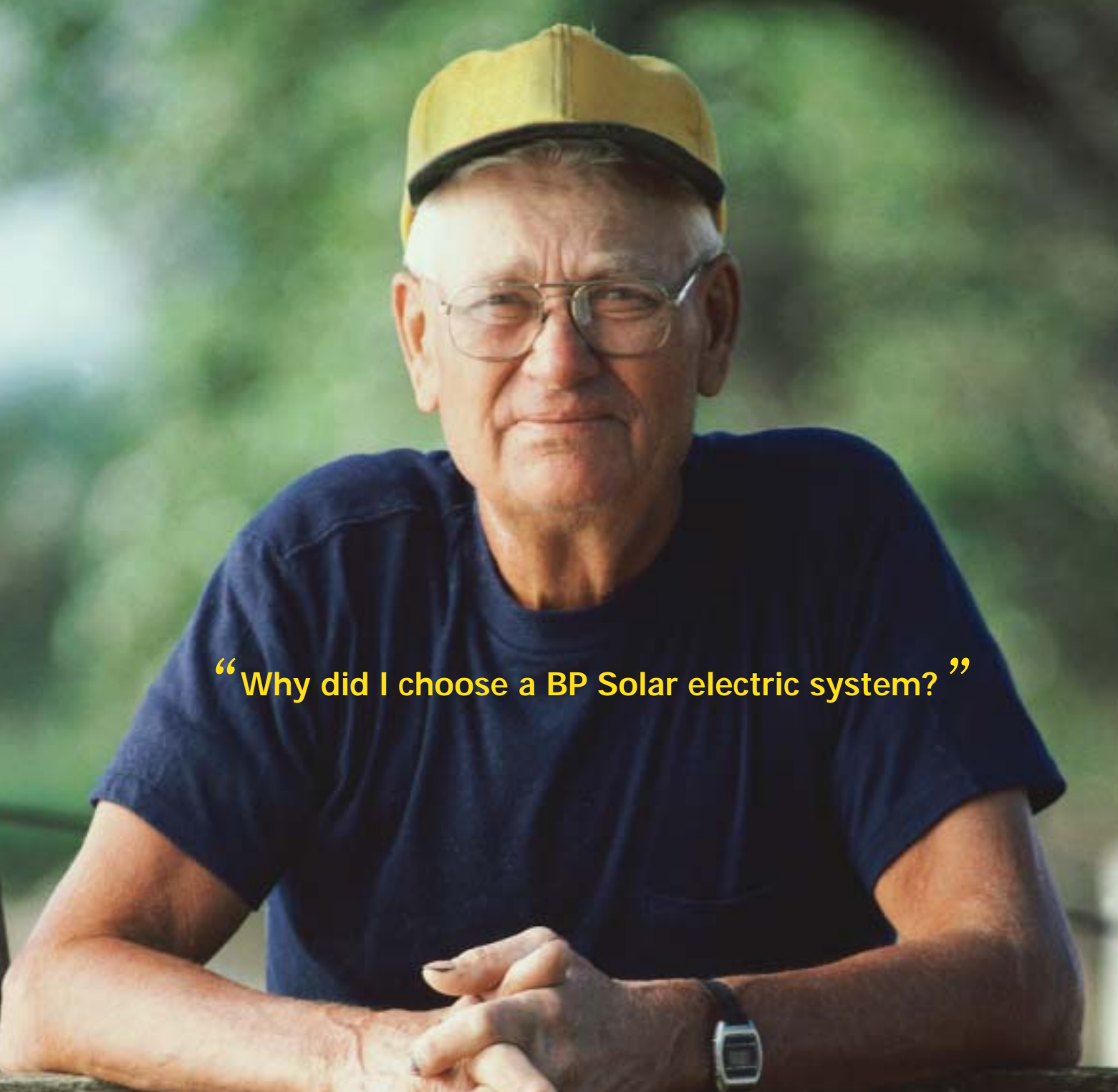

“Why did I choose a BP Solar electric system?”

Watch our website for dates and locations of BP Solar distributor training.

USA  
**Alternative Solar Products - California**  
Toll Free: 800.229.7652  
Phone: 909.308.2366  
E-mail: mark@alternativesolar.com  
Internet: www.alternativesolar.com

**Atlantic Solar Products, Inc. - Maryland**  
Toll Free: 800.807.2857  
Phone: 410.686.2500  
E-mail: mail@atlanticsolar.com  
Internet: www.atlanticsolar.com

**Dankoff Solar Products - New Mexico**  
Toll Free: 888.396.6611  
Phone: 505.473.3800  
E-mail: pumps@dankoffsolar.com  
Internet: www.dankoffsolar.com

**Effective Solar Products - Louisiana**  
Toll Free: 888.824.0090  
Phone: 504.537.0090  
E-mail: esp@effectivesolar.com  
Internet: www.effectivesolar.com

**Hutton Communications - Georgia**  
Toll Free: 877.896.2806  
Phone: 770.963.1380  
Fax: 770.963.9335  
E-mail: sales@huttonsolar.com  
Internet: www.huttonsolar.com

**Intermountain Solar Technologies - Utah**  
Toll Free: 800.671.0169  
Phone: 801.501.9353  
E-mail: orrin@intermountainsolar.com  
Internet: www.intermountainwholesale.com

**Polar Wire - Alaska**  
Phone: 907.561.5955  
Fax: 907.561.4233  
E-mail: sales@polarwire.com  
Internet: www.polarwire.com

**Solar Depot, Inc. - California**  
Toll Free: 707.766.7727  
Phone: 800.822.4041  
E-mail: info@solardepot.com  
Internet: www.solardepot.com

**XANTREX**  
Smart Choice For Power

**MORNINGSTAR**  
SOLAR ELECTRONICS

**Surrette**

**Aeca**  
Precision Electronics  
Solar Electronics  
Battery Charging Systems  
Lithium Technology

**OutBack**  
Power Systems



“I was really impressed by the BP Solar dealer’s know-how and professionalism. He took the time to help me understand the product choices I had. Then he designed and installed a system that was exactly what I needed.

It gave me a lot of confidence to learn that BP Solar products have been around for more than thirty years. My dealer also explained the components he used were designed to match BP Solar modules—making it a superior system. That’s why I’m assured of years of reliable performance.”

**the natural source for electricity®**

1973–2003

Celebrating 30 Years of Excellence

**Southwest PV Systems - Texas**

Toll Free: 800.899.7978  
Phone: 281.351.0031  
E-mail: swpv@southwestpv.com  
Internet: www.southwestpv.com

**Sun Amp Power Company - Arizona**

Toll Free: 800.677.6527  
Phone: 480.922.9782  
E-mail: sunamp@sunamp.com  
Internet: www.sunamp.com

**Talmage Solar Engineering, Inc. -**

**Solar Market - Maine**  
Toll Free: 877.785.0088  
Phone: 207.985.0088  
E-mail: sm@solarmarket.com  
Internet: www.solarmarket.com

**CANADA**

**Generation PV, Inc. - Ontario**  
Toll Free: 800.311.4286  
Phone: 905.831.6111  
E-mail: info@generationpv.com  
Internet: www.generationpv.com

**Soltek Powersource Ltd. - Alberta**

Toll Free: 888.291.9039  
Phone: 403.291.9039  
E-mail: sps@spsenergy.com  
Internet: www.spsenergy.com

**Soltek Powersource Ltd. -**

**British Columbia**  
Toll Free: 800.667.6527  
Phone: 250.544.2115  
E-mail: sps@spsenergy.com  
Internet: www.spsenergy.com

**Soltek Powersource Ltd - Ontario**

Toll Free: 888.300.3037  
Phone: 705.737.1555  
E-mail: sps@spsenergy.com  
Internet: www.spsenergy.com

**Trans-Canada Energie - Quebec**

Toll Free: 800.661.3330  
Phone: 450.348.2370  
E-mail: rozonbatteries@yahoo.com  
Internet: www.worldbatteries.com



# NOW in the US!

**UL Listed  
700 and 1100 Watt Inverters  
Available Now!**

## Sunny Boy 2500 / 1800

- SMA, the leading supplier of grid tied PV systems in Europe, is now in the US!
- Get to know our trend setting technology of String Inverters
- We have over 60 MW AC of total "Sunny Boy String Inverter" power installed so far
- Over 40,000 Sunny Boy String Inverters sold up to now

**Now UL Listed to UL 1741  
for Grid Interactive Inverters**



### Join our Sunny Family and benefit from our Sunny Boy String Inverters with ...

- 5 Year Warranty - reliable and safe!
- Our Sunny Boys meet highest quality requirements - see our results in high-quality tests!
- Easy Outdoor Mounting with Protection Class NEMA 4X / IP 65
- Easy to install by using a three-point mounting system
- Multiple Communications and data collections that can be customized for any system



SMA America, Inc.  
12438 Loma Rica Drive  
Grass Valley, CA 95945

Phone 530 - 273 - 4895  
Fax 530 - 274 - 7271

**Advanced System Technology for  
the Successful Photovoltaic Future**



[www.SMA-AMERICA.com](http://www.SMA-AMERICA.com) • [www.SMA.de](http://www.SMA.de)

# RECYCLED POWER



At U.S. Battery, we're committed to doing our part in keeping the environment clean and green for future generations, as well as providing you with premium deep cycle products guaranteed to deliver your power requirements when you need them.



**DON'T SETTLE  
FOR ANYTHING LESS  
THAN U.S. BATTERY  
PRODUCTS!**

1675 Sampson Ave. Corona, CA 91719 (800) 695-0945 / 653 Industrial Park Dr., Evans, GA 30809 (800) 522-0945

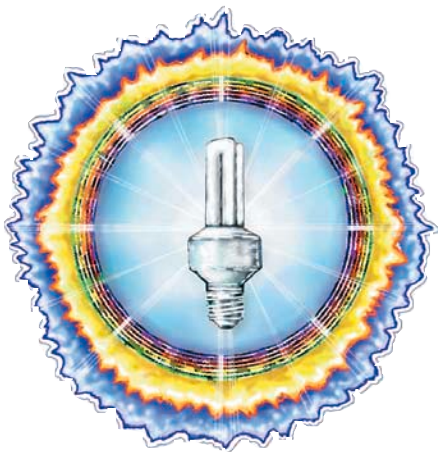

# HOME POWER

THE HANDS-ON JOURNAL OF HOME-MADE POWER

Issue #94

April / May 2003

## Features



- 10** **Solar Chocolate in Belize**  
*Christopher Nesbitt works with an organic cacao growers' cooperative in Toledo, Belize to install solar powered irrigation for the seedlings.*

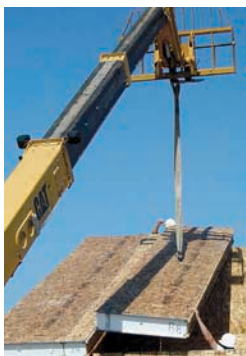

- 36** **Solar Decathlon Converges on Washington**  
*Fourteen colleges and universities built energy efficient homes on the National Mall in Washington, D.C. Innovation, creativity, and renewable energy prevailed. We hope the politicians took notice.*



- 50** **Installing Solar Domestic Hot Water, Part 1**  
*Chuck and Ken put wrench to roof in the first part of a how-to series. In this issue: collector orientation, mounting, and plumbing.*



- 70** **Solar Pool Heating, Part 1**  
*Heating your swimming pool with the sun is one of the most simple and cost-effective uses for solar energy. Tom Lane helps you extend your fun in the sun, using the sun.*

## More Features

- 22** **Getting the Data from a Photovoltaic System**  
*The Simons family installed a grid-intertied photovoltaic system with battery backup, and a monitoring system to keep tabs on every variable.*

- 30** **The Pros & Cons of Solar Subsidies**  
*There are good reasons for using subsidies to promote renewable energy—and good reasons not to.*

- 62** **Mobile PV Intertie?**  
*Gerald Lemay has the best of both worlds, a mobile PV education station built into his van, and a place to plug in for net metering.*

- 88** **What Goes Up Shouldn't Always Come Down**  
*Luckily nobody was hurt when Bruce Johnson's 54 foot tower and wind generator came down without warning.*

## Solar Thermal

## What the Heck?

- 49** **Differential Control**  
*The brains of a solar hot water system.*

- 80** **Disconnect**  
*Open or closed, on or off—that's all there is to it.*



Cover: Fourteen colleges and universities competed and collaborated in the Solar Decathlon in Washington, D.C.

## Guerrilla

- 82** **Guerrilla Solar 0025**  
*Guerrilla international: living in an apartment didn't stop this guerrilla from installing PV in Slovenia.*

## GoPower

- 92** **Current Choices & Future Fantasies**  
*Shari Prange explores the truths, hopes, and pipe dreams of the three main types of alternative vehicles: electric, hybrid, and fuel cell.*
- 100** **EV Tech Talk**  
*Owner's Guide, Part 2: subtleties of charging batteries, mechanical maintenance, and driving techniques for efficiency and long life.*

## Columns

- 112** **Independent Power Providers**  
*No time to rest—successful PV legislation is not set in stone. Don Loweburg gives warning of utility challenges to net metering.*
- 106** **Code Corner**  
*John Wiles sets out to design and install a National Electric Code compliant residential photovoltaic system—it can be done.*

## More Columns

- 116** **Power Politics**  
*A lot of dirty words: oil, nuclear waste, money, etc.*
- 120** **Word Power**  
*Insulator defined.*
- 122** **Home & Heart**  
*Fire Line, Part IV—Sometimes it's good to be hosed.*
- 130** **The Wiz**  
*Time, space, and energy.*
- 138** **Ozonal Notes**  
*Richard Perez is very proud of our President—surely it was GW's wise decision to put solar on the White House.*

## Regulars

- 8** **From Us to You**
- 80** **HP's Subscription Form**
- 81** **Home Power's Biz Page**
- 126** **Happenings—RE Events**
- 129** **Writing for Home Power**
- 132** **Letters to Home Power**
- 140** **Q&A**
- 142** **MicroAds**
- 144** **Index to Advertisers**

## Access and Info

### Access Data

Home Power  
PO Box 520  
Ashland, OR 97520 USA

Subscriptions and Back Issues:  
800-707-6585 VISA, MC  
Discover, & American Express  
541-512-0201 Outside USA

### Advertising:

Phone: 800-707-6585  
or 541-512-0201 Outside USA  
Fax: 541-512-0343

E-mail: [hp@homepower.com](mailto:hp@homepower.com)

Web: [www.homepower.com](http://www.homepower.com)

### Paper and Ink Data

Cover paper is Aero Gloss, a 100#, 10% recycled (postconsumer-waste), elemental chlorine-free paper, manufactured by Sappi Fine Paper.

Interior paper is Ultra LWC Glossy, a 45#, 100% postconsumer-waste, totally chlorine-free paper, manufactured by Leipa, an environmentally responsible mill based in Schwedt, Germany.

Printed using low VOC vegetable-based inks.

### Printed by

St. Croix Press, Inc., New Richmond, WI

### Legal

*Home Power* (ISSN 1050-2416) is published bi-monthly for \$22.50 per year at PO Box 520, Ashland, OR 97520. International surface subscription for US\$30. Periodicals postage paid at Ashland, OR, and at additional mailing offices. POSTMASTER send address corrections to *Home Power*, PO Box 520, Ashland, OR 97520.

Copyright ©2003 *Home Power*, Inc.

All rights reserved. Contents may not be reprinted or otherwise reproduced without written permission.

While *Home Power* magazine strives for clarity and accuracy, we assume no responsibility or liability for the use of this information.



This paper is recycled and recyclable.

# Where's **HOME POWER?**



Can you find *Home Power* on this magazine rack? Most of our faithful subscribers can, but a lot of the folks we want to introduce to renewable energy can't. Just as renewable energy gets lost in the mass media, *Home Power* gets lost on the newsstand. We have a plan to overcome this. Next issue, we'll be unveiling a new cover design for *Home Power*.

For renewable energy to have a positive effect on the planet, its use has to grow. The main goal of *Home Power* is to introduce and educate new folks to the wonders of renewables. First we have to get their attention and inspire them with the benefits of renewable energy (RE). Then, we have to keep their attention while we explain such REsoterica as amp-hours, phantom loads, wire sizing, and overcurrent protection. This is quite a challenge these days, when most media use bits of information shorter than an average TV commercial.

To attract new readers, *Home Power* has to be seen. Our new look will stand out amongst the other glossy rags on the magazine rack. We'll still be focused on solid, RE content. We want to attract more readers to that content with a bold and bright new look.

We'll be making some changes to the inside of the magazine too. Don't worry, there will still be lots of real data, and hands-on, how-to information—in fact we plan to have even more. The format of articles will be more approachable by new readers. We can't expect everyone to be wrench savvy right away, and we want the magazine to help beginners, not scare them away.

We're convinced that you'll like *Home Power's* new look—we love it! We're psyched about getting renewable energy technologies into the mainstream, and if that means being a little more flashy, well, we might as well have fun with it.

—Ben & Eric, *HP* Art Department, and the *Home Power* crew

## People

Mike Brown  
 Catherine Buxton  
 Sam Coleman  
 Marika Kempa  
 Rick Germany  
 Eric Grisen  
 Kathleen Jarschke-Schultze  
 Bruce Johnson  
 Stan Krute  
 Don Kulha  
 Tom Lane  
 Gerald Lemay  
 Don Loweberg  
 Chuck Marken  
 Christopher Nesbitt  
 Ken Olson  
 Karen Perez  
 Richard Perez  
 Linda Pinkham  
 Shari Prange  
 Benjamin Root  
 Shannon Ryan  
 Connie Said  
 Brent Simons  
 Joe Schwartz  
 Michael Welch  
 John Wiles  
 Dave Wilmeth  
 Mark Wilkerson  
 Ian Woofenden  
 Zeke Yewdall  
 Solar Guerrilla 0025

**“Think about it...”**

*Why not go out on a limb?  
 That's where the fruit is.*

— Will Rogers

# RE professionals demand flexibility.

**Rpowr™  
home  
energy  
appliances  
deliver.**

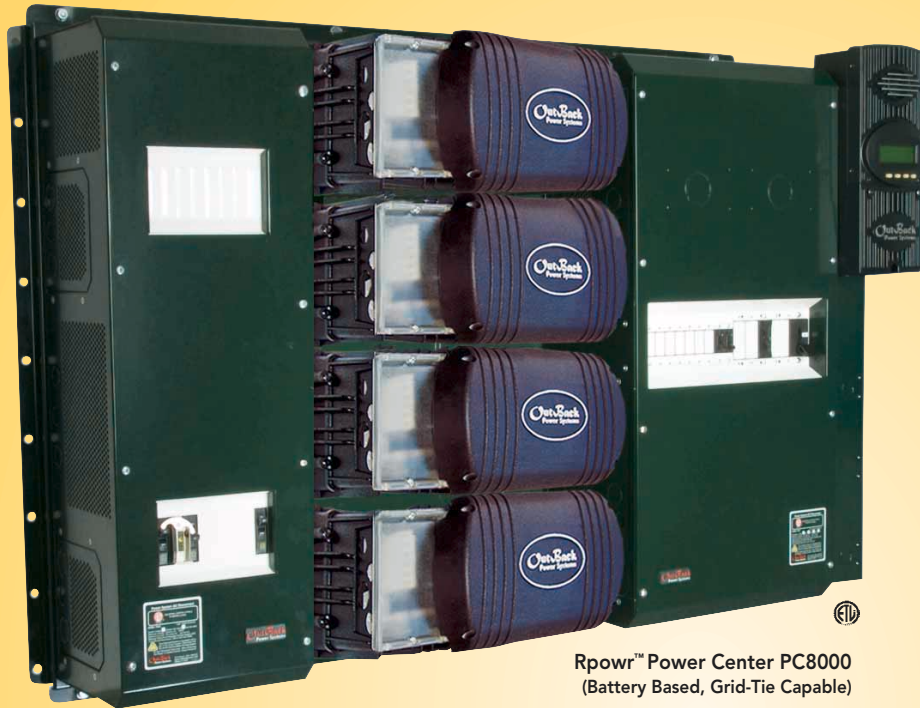

Rpowr™ Power Center PC8000  
(Battery Based, Grid-Tie Capable)

**Rpowr™**  
By Energy Outfitters Ltd



Rpowr™ Power Center PC4024  
(Battery Based, Grid-Tie Capable)



Rpowr™ 2500GT  
Grid-Tie System



Rpowr™ RP2000  
Reserve Power System

**ETL listed products built by us to your specifications or components to build your own system, shipped ready to assemble.**

**We're expecting your call.**

Dealer inquiries welcome.



543 Northeast "E" St • Grants Pass, Oregon 97526 • **800 GO SOLAR**  
(800 467-6527) • [energyoutfitters.com](http://energyoutfitters.com)

# Renewable Chocolate!

Solar Pumping for Organic Cacao Growers in Belize

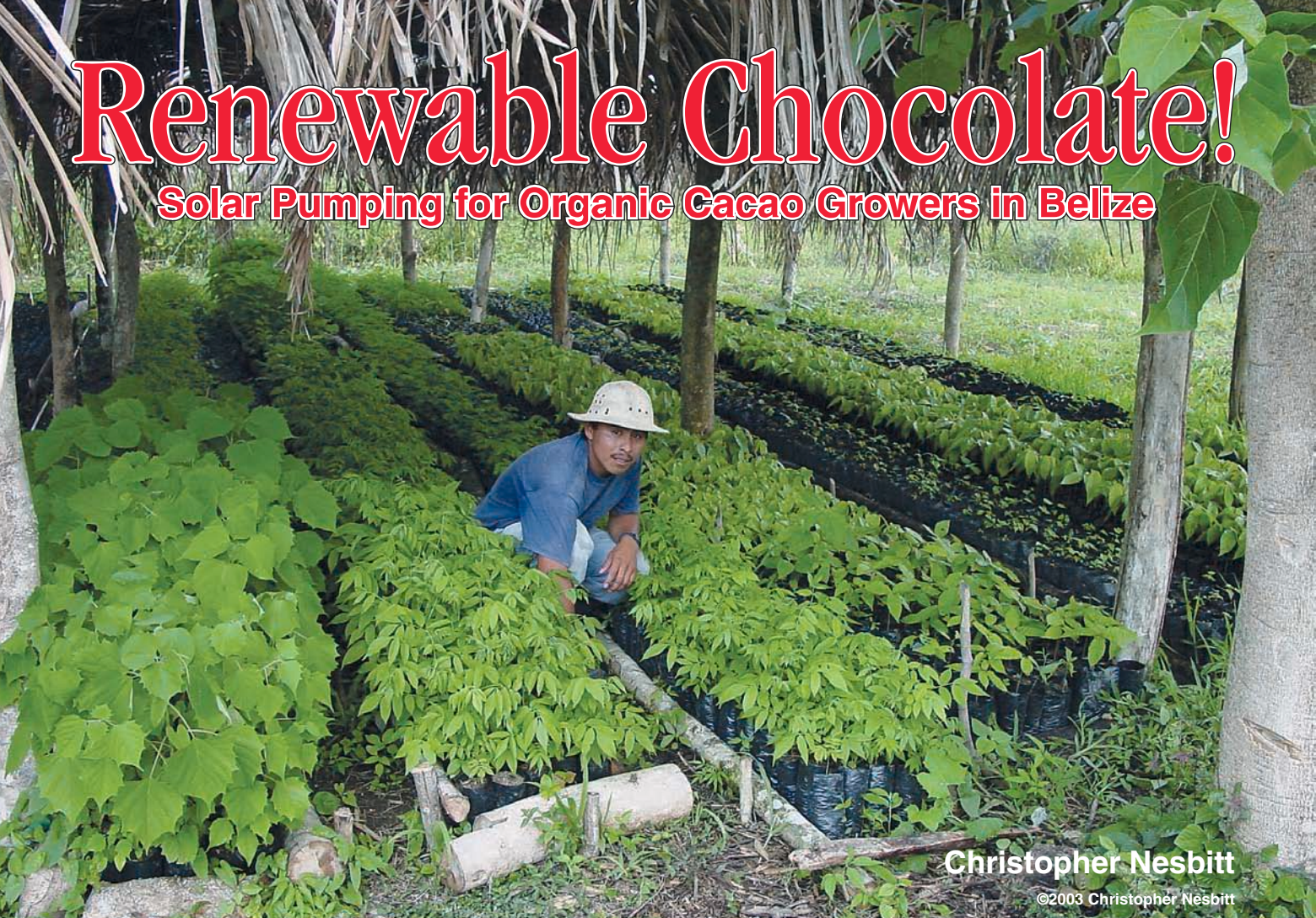

Christopher Nesbitt

©2003 Christopher Nesbitt

Organic chocolate farmer Auxibio Sho irrigates his seedlings with a solar powered water pumping system.

**I** work with the Toledo Cacao Growers Association (TCGA), Belize's only certified organic cooperative. TCGA is a democratically run organization established in 1986, and has been selling cacao to Green & Black's, a UK organic chocolate company, since 1993.

*Theobroma cacao* is a tropical subcanopy tree that produces seed-carrying pods. After harvesting the ripe pods and fermenting, drying, roasting, grinding, and processing the seeds, these seeds become cocoa, and cocoa makes chocolate. You may have seen Maya Gold, the dark chocolate with an orange flavor that Green & Black's makes from TCGA's cacao.

#### Catastrophe & Reconstruction

TCGA has about two hundred members, most of which

are subsistence farmers who grow cacao for the export market. Our membership is 99 percent Kekchi Maya and Mopan Maya, spread out over seventeen villages. Of these villages, twelve were hit in 2001 by Hurricane Iris, the most ferocious storm Toledo has seen in more than sixty years. The damage to the economy of Toledo District, already the poorest district in the country, was catastrophic.

When the people of Toledo saw the rising sun the next day, they were confronted by broken and uprooted trees, a destroyed electricity grid, and damaged housing. Most of the traditional crops that Toledo's farmers subsist on—rice, beans, and corn—were laid down in the mud.

Foreign-currency-winning crops like citrus and cacao were also damaged, with a complete loss of the year's citrus crop, and severe damage to the cacao groves. Many farmers depend on the income they make from these crops. While the citrus only lost its fruit and flowers, the cacao needs a canopy of shade trees to

protect it from sun. The shade trees also mine nutrients from the subsoil, dropping it to the forest floor in the form of leaves, flowers, fruit, and branches, where it is broken down and made available to the cacao plants. With much of the shade gone, the cacao was not sheltered. This important nutrient cycle, especially important for the organic cacao that TCGA's members grow, was broken.

When the hurricane hit Belize, the Toledo Cacao Growers Association was already working on a plan to establish five nurseries in various communities to expand the acreage of organic cacao in the district. The plan included valuable timber trees as an integral component. This proposal was being facilitated by an American NGO called Trees for the Future; its local partner, Trees Belize; and the Community Initiated Agricultural Development (CARD) Project.

### Three Solar Water Pumping Systems

We were able to place two of the five nurseries in communities where there was piped water. This left three nurseries in need of water. Since our family farm has been using solar pumps for our irrigation and home water system for the last six years, I thought it would be neat if we could figure a way for these nurseries to be solar pumped.

**Photovoltaic panels in the equatorial latitudes of Belize need only enough tilt to shed rain.**



**The home of TCGA chairman and cacao farmer Mr. Pablo in San Antonio Village, Toledo, Belize.**

Local and international funding enabled TCGA to pay for most of the equipment for two systems built around the Solar Force piston pump by Dankoff Solar Products. Plenty International donated a Shurflo submersible pump that had been on loan. A substantial grant made by the Unity Avenue Fund and a grant made available to TCGA by the UK-based Methodist Relief and Development Fund paid for the balance of the piston pump systems. Green & Black's donated some additional funds to assist TCGA in its efforts to rebuild, a portion of which was used to buy pipes, tanks, hose, and two solar-electric panels.

The three nurseries with solar powered water pumping are in the villages of San Antonio, San Pedro Columbia, and San Jose. These are all cacao producing villages that TCGA has targeted, where expansion is possible by both finding new members and encouraging existing members to expand their acreage.

### Mr. Pablo's System, San Antonio Village

San Antonio Village is the largest Maya settlement in Toledo. It is predominantly a Mopan Maya village, and is the single largest cacao producing village in Toledo, with seventy producing members, and dozens of newer members who have not yet started reaping.

Mr. Pablo is TCGA's chairman. He is widely respected in the community as an honest and hard working farmer. He grows citrus organically, keeps bees, and grows vegetables, beans, and corn in addition to his cacao. His farm is at the end of a small road, 1 1/2 miles (2.4 km) from the village.

## Solar Water Pumping

Mr. Pablo's nursery has a Shurflo submersible pump, powered by two Siemens SP75 panels wired in series for 24 VDC, with a controller. The panels are mounted on a rack made of sticks and bamboo. Mr. Pablo pumps his water from a "living spring" that never runs dry. He found it many years ago and has developed it. It is 120 feet (37 m) down the hill from his house, and before the days of the pump, he and his family collected water by bucket and carried it all the way to where his house is.

His system was originally a single panel system that I installed in 2001 while working with Plenty. When the pump arrived, it had been shipped with some skinny wire, and without thinking about it too much, I installed it using that wire. It never pumped as much water as expected, and when Ed Eaton of Solar Energy International (SEI) was down here, he looked at the system and fixed the poor job I did by installing properly sized wire.

Even though I have lived with solar electricity for years on our farm (see *HP67*), I wrongly assumed that the wire was sized for the pump and used it, even though in retrospect, it was obviously grossly undersized. This underscores the need for proper education in solar technology that groups like SEI can provide.

Mr. Pablo's Shurflo submersible pumps about 1 1/2 gallons (5.7 l) per minute up the hill. It has never needed any maintenance, and has proven very reliable in the year and a half it has been installed.

While we were waiting last year for the solar-electric panel for this original system to arrive, we decided to

**Water from Mr. Pablo's spring used to be carried in buckets—now the sun does the work.**

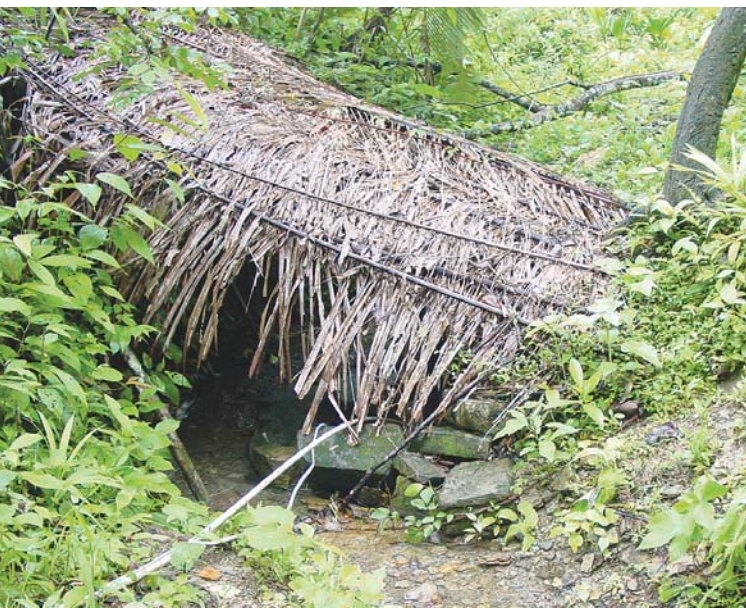

**Mr. Pablo, farmer and head of the Toledo Cacao Growers Association, is proud to use renewable energy and organic farming techniques.**

use one of my extra panels, a Photowatt 75 watt panel. When the Siemens 75 watt panel finally arrived, Melanie at Plenty suggested that I just keep the Siemens panel and leave the Photowatt where it was. I figured a PV is a PV, right? Wrong, apparently. As Ed explained it to me, the voltage of all crystalline PVs drops as temperature increases. But single-crystalline PVs tend to be less affected by high temperatures than polycrystalline modules, like the Photowatt.

Two new Siemens panels arrived, and all I had to do was remove the Photowatt panel, and install the two 75 watt panels in series for 24 volts nominal. I configured the pump control to 24 volts, and *presto*, the pump was pumping double what it had at 12 volts on the single panel.

Mr. Pablo gets plenty of water to his house. This water kept his 8,000 seedling trees wet without a hitch. When the rainy season started again, all the trees went out for planting, and next year, TCGA will use this and the other nursery sites again.

### Seeking Better Pumps

When I started looking into what sort of pumps we should use in the other two nurseries, I wanted efficient

and trouble-free pumping. Mr. Pablo's Shurflo submersible pump has been trouble free, but we wanted something with more volume and longer projected lifespan for the rest of the nurseries. There is no UPS truck to deliver replacement parts in Belize, and shipping is expensive. In addition, everything that comes into Belize is charged duty. And the thought of having downtime while waiting for a part was troubling.

I did some research and contacted Windy Dankoff at Dankoff Solar, explaining what we needed. Windy suggested the Solar Force piston pump. I have actually been considering a Solar Force pump for a few years for our farm to replace the seemingly never-ending series of inexpensive Shurflo and Flojet diaphragm pumps that we have gone through—about one a year.

The folks at Dankoff designed two systems with Solar Force piston pumps and two 75 watt BP275 panels. One of them is at Ignacio Ash's farm in San Pedro Columbia, where he waters 10,000 trees in bags. The other is at Auxibio Sho's farm in San Jose and is used to irrigate the 8,000 trees in his nursery. The pumps themselves are heavy. They are solidly built and look as if they will easily last the 20 years that Windy says they can.

Taylor Steele at Dankoff Solar handled getting our order together. He took the time to find a less expensive air freight carrier that saved TCGA a few hundred dollars. In addition to this, a percentage of the equipment was donated to TCGA by Dankoff Solar.



**A Dankoff Solar Force piston pump runs efficiently on 24 volts DC from a couple of PV panels.**

**Ignacio Ash's System, San Pedro Columbia Village**  
San Pedro Columbia is the largest Kekchi Maya settlement in Belize. It was established in the early 20th century by immigrant Kekchis fleeing forced labor and conscription in Guatemala. There are about twenty producing cacao farmers here, but roughly forty new farmers are planting cacao now. San Pedro Columbia is notable for having Belize's oldest producing cacao groves. Two, 20 acre cacao groves were planted around 1905.

**Two BP275 photovoltaic modules directly power the Solar Force piston pumps for two identical pumping systems for organic cacao farmers Ignacio Ash (shown) and Auxibio Sho.**



Ignacio is the TCGA's extension officer and works part-time in other communities encouraging farmers to plant more cacao. His farm is 2 miles (3.2 km) up the river from the village. The only way to access his farm is by walking or by canoe. His farm is situated in a beautiful valley near where the river comes out of the ground. He is an industrious farmer, and a friend. My wife and I are lucky to have him as our neighbor across the river from our farm.

Ignacio Ash has two, BP275 panels mounted on a UniRac U-22-44M, top-of-pole PV rack. This is connected to a Dankoff pump controller (linear current booster) LCB-8A and then to a Dankoff Solar Force piston pump.

The system arrived in a small mountain of boxes, and I have to admit I was a wee bit intimidated on seeing them all. But the instructions were easy to understand, and with Plenty volunteer Mark Miller, it took us a few hours to set everything up, lay the pipes, and install the foot valve. When we turned the switches in the controller, the pump came to life.

Ignacio had already laid pipe into a pool in the river near where he ties his canoe. The river is clear and cold, since the source is only a few hundred meters up the valley from the pump site. We poured water in through the top of the pump, but it didn't pump. From reading the manual, we knew that this was because the leather piston seals needed to expand a bit. Lacking the tools to dismantle the pump and stretch the leathers manually, we left it for another day.

Two days later, I came over to Ignacio's farm, tool kit in hand, expecting to dismantle the pump. I was pleasantly surprised to see the pump quietly pumping away. Apparently the leathers needed only a bit of time and some water to expand on their own. Gushing out the end of the pipe was clear cold water. We filled a 5 gallon (19 l) bucket in about a minute.

Ignacio had set the two, 75 watt BP panels on a UniRac pole mount, but lacking a pole, he mounted the rack on a guava branch buried about 36 inches (91 cm) into the ground. Eventually he plans to get a pole and set it in concrete, but he likes his guava mount for now.

# How Does a Solar Water Pump Work?

Windy Dankoff

©2003 Windy Dankoff

The TCGA project uses solar-electric panels to power a special type of pump. They are solar-direct, which means they have no batteries. They pump only during the day when there is sufficient sunlight. Like a traditional water pumping windmill, a solar-direct pump is typically used to fill a storage tank. The tank is sized to hold at least five days of water supply for use on cloudy days and at night. A water tank is cheaper and more durable than the equivalent energy storage in batteries.

The Dankoff Solar Force piston pump differs from a conventional electric pump in three fundamental ways.

1. It uses a DC (rather than AC) motor that varies its speed in response to the available solar power.
2. It uses a positive displacement mechanism that efficiently forces water up, even when running slowly. Other pumps use a centrifugal mechanism that loses its vertical lift capacity when the speed is reduced.
3. It uses less than half the energy of a centrifugal pump, thus minimizing the size and cost of the solar-electric array.

Between the array and the pump is the controller. This is an electronic device that matches the power from the array to the demands of the pump motor. The pump forces water up as soon as it begins to turn, demanding full torque from the motor. In weak sunlight, the array supplies full voltage, but reduced current (amps). The current produces the torque in the motor. So, the controller reduces voltage and increases current so the motor can start and run even in weak sunlight. It's like starting your vehicle in low gear.

These systems represent one type of solar pump. Another option is to use a submersible pump. Another variation is to use a battery system. This has the advantage of pumping at any time, which is the key to keeping water pressurized. A pressure system eliminates the need for an elevated storage tank. Many remote homeowners choose a battery-based pumping system for that reason. They can run it on the same battery bank that supplies their lights and appliances.

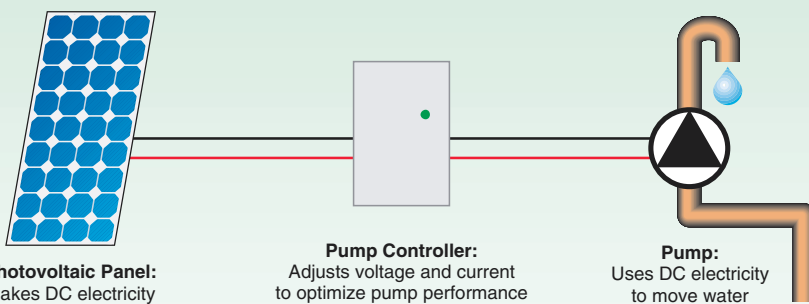





**The author tends young shade trees.**

Ignacio has since laid a few hundred feet of pipe up the hill to a 400 gallon (1,500 l) tank, which he uses to gravity feed the nursery site and his house. The nursery at his house handles 10,000 trees.

#### **Auxibio Sho's System, San Jose Village**

San Jose was established when San Antonio village subdivided and a percentage of the village moved there to look for new land. There are about seventy producing members there, and about thirty farmers who have young cacao that is not producing yet. (Cacao takes five years from planting to first harvest.) Cacao is the single

**Healthy cacao seedlings thrive in the shade, drinking clean water pumped by the sun.**



## A Blatant Plug for Great Chocolate

Toledo Cacao Growers Association sells 100 percent of its cacao to a small, ethically minded, organic chocolate company in London called Green & Black's. This cacao is transformed into a fine, orange-flavored, organic dark chocolate called Maya Gold.

Green & Black's was the first company to sell certified organic chocolate, and Maya Gold was the first cocoa product to earn the Fairtrade mark. Fairtrade is a third party certifier that seeks to help ameliorate the inherent inequalities in North-South trade and buffer the effects of the highly volatile international market on pricing for cacao, coffee, sugar, tea, bananas, citrus, honey, and mangoes for producers in developing countries.

Green & Black's has a deep commitment to the producer groups that provide them with cacao. They have eight types of bar chocolate, all organic, ranging from organic milk chocolate to organic dark chocolate, and they are all very, very good.

By being certified organic and certified Fairtrade, the farmers at TCGA have a stable price that doesn't fluctuate like the extremely volatile world market price for cacao. A few years back, the world market price dropped significantly. The farmers at TCGA were getting three times the world market price for their cacao.

TCGA and Green & Black's have what is called a five-year rolling contract, which means that every morning when the sun rises, the farmers have a guaranteed market for 100 percent of their cacao at the third party Fairtrade mandated price for the next five years. This gives stability, and allows farmers to plan ahead. In the unlikely event that Green & Black's wanted to stop buying cacao from TCGA, they would have to give TCGA a five-year notice of their intentions. This would allow the cooperative five years to find another buyer.

If you see a Green & Black's product on the shelf—buy it! I am sure you will like it. If your local health food store or cooperative doesn't have it, ask them to carry it. By purchasing organic, Fairtrade chocolate, you are supporting small cooperatives, sustainable agriculture, and ethical trade. Eat Maya Gold!



100g e Net Wt. 3.5OZ



## Single Pumping System Costs

<i>Item</i>	<i>Cost (US\$)</i>
Dankoff Solar Force 3020-24PV pump	\$1,510.00
2 BP275 PV modules, 75 W	885.00
Dankoff LCB-8A pump controller	140.00
UniRac U-22-44M top-of-pole PV mount	127.00
Solar Force seal & belt kit (spare parts)	75.00
Foot valve, 1 1/4 inch	25.00
<i>Total</i>	<b>\$2,762.00</b>

biggest currency winner for San Jose, and San Jose has TCGA's most enthusiastic members.

Auxibio Sho is one of TCGA's youngest members. He is a committed organic farmer who was once Junior Farmer of the Year for the entire nation of Belize. He is one of TCGA's elected executive members. He works for the Ministry of Agriculture as an extension officer. He also has 200 watts of solar-electric panels and a battery bank at his house to run lights, stereo, and fans. To sharpen his machete, he built his own 12 volt grinder fashioned from an engine cooling fan motor.

Auxibio has exactly the same system and components as Ignacio Ash. Auxibio has an underground stream about 20 feet (6 m) below the surface in a cave. It is something to see, all that water passing through the cave at the bottom of a 20 foot vertical tube of rock, and it is clear, cold water. Because of the amount of water, and the purity, Auxibio decided to use this source of water instead of using surface water from a nearby creek.

Auxibio, Ignacio Ash, and I installed the system. Auxibio did not have the right size pipe to install the foot valve, so we left that, and he said he would do it himself the next time he had an opportunity to buy some pipe. When I returned to San Jose to visit with some other cacao farmers a few days later, I stopped in and the system was quietly pumping 5 gallons (19 l) per minute.

Auxibio's farm is in a valley, and there is not a large change in elevation (perhaps 40 feet; 12 m) between his pump and his tank. So he pumps directly to a garden hose and waters the 8,000 plants in his nursery. What isn't needed at the time, is pumped to a ferro-cement tank and is used for domestic water, other crops, chickens, and pigs.

The Solar Force piston pumps in Ignacio's and Auxibio's systems work beautifully. They pump 5 gallons (19 l) per minute of water on only 150 watts of PV, and they are quiet. I would not hesitate to recommend them to anyone, and sooner or later, I am going to spring for one myself.

## Long-Term Benefits

These nurseries are helping TCGA rebuild the cacao industry, replanting damaged shade trees this year and expanding cacao acreage. The nurseries will be available in future years for further expansion of the organic cacao industry in Belize.

I like it when many people work together and make something exciting happen. These projects were made possible by the combined efforts and generosity of many people. SEI, Plenty International, Unity Avenue Foundation, Green & Black's, Trees for the Future, Trees Belize, the CARD Project, Fairtrade Foundation, the Methodist Relief and Development Fund, support from Dankoff Solar Products, and the work of the farmers and staff of the Toledo Cacao Growers Association made this happen. Mark Cohen, of the Belize Agroforestry Research Center, even donated an old ARCO panel to TCGA with the understanding that we would sell it to buy some pipe.

I am a firm believer in the benefits of organic cacao to Belize's environment and economy, and the benefits of converting the sun's rays to electricity to pump water. I would like to thank everyone who helped make this happen. It was wonderful to work with so many different people and have something very positive to show for it in the end.

## Access

Christopher Nesbitt, Liaison Officer, Toledo Cacao Growers Association, Farmers Depot, Punta Gorda Town, Belize, Central America • 501-722-2992  
[toucanpro@btl.net](mailto:toucanpro@btl.net)

## Donors:

Unity Avenue Foundation, PO Box 204, Bayport, MN 55003 • 888-439-9508 or 651-439-1557  
 Fax: 651-439-9480 • [minalindelof@scenicriver.org](mailto:minalindelof@scenicriver.org)  
[www.scenicriver.org/ua](http://www.scenicriver.org/ua)

Plenty International, Box 394, Summertown, TN 38483  
 931-964-4323 • [plenty@plenty.org](mailto:plenty@plenty.org) • [www.plenty.org](http://www.plenty.org)

Plenty Belize, Box 72, Punta Gorda Town, Belize, Central America • Phone/Fax: 011-501-722-2198  
[plentybz@btl.net](mailto:plentybz@btl.net) • [www.plenty.org/belizeprojects.htm](http://www.plenty.org/belizeprojects.htm)

Fairtrade Foundation, Suite 204, 16 Baldwin's Gardens, London, EC1N 7RJ, UK • +44 (0) 20 7405 5942  
 Fax: +44 (0)20 7405 5943 • [mail@fairtrade.org.uk](mailto:mail@fairtrade.org.uk)  
[www.fairtrade.org.uk](http://www.fairtrade.org.uk)

Methodist Relief & Development Fund, Methodist Church House, 25 Marylebone Road, London, NW1 5JR, UK • +44 (0) 20 7486 5502  
[mrdf@methodistchurch.org.uk](mailto:mrdf@methodistchurch.org.uk) • [www.mrdf.org.uk](http://www.mrdf.org.uk)

Green & Black's, 2 Valentine Pl., London, SE1 8QH, UK  
 020-7633-5900 • enquiries@greenandblacks.co.uk  
 www.greenandblacks.com

Toledo Cacao Growers Association, Farmers Depot,  
 Punta Gorda Town, Belize, Central America  
 Phone/Fax: 501-722-2992 • tcga@btl.net

Solar Energy International (SEI), PO Box 715,  
 Carbondale, CO 81623 • 970-963-8855  
 Fax: 970-963-8866 • sei@solarenergy.org  
 www.solarenergy.org

Tropical Conservation Foundation (TCF), PO Box 42  
 Athens, OH 45701 • 740-448-2044  
 markdcohen@hotmail.com • www.tcf-barc.org

Belize Agroforestry Research Center (BARC), PO Box  
 6, Punta Gorda, Toledo District, Belize, Central America  
 tcf@frognet.net • www.tcf-barc.org

Trees for the Future, PO Box 7027, Silver Spring MD,  
 20907 • 301-565- 5012 • Fax: 301-565-5120  
 info@treesftf.org • www.treesftf.org

Trees Belize, PO Box 423, Belmopan, Cayo, Belize,  
 Central America • treesbelize@hotmail.com

Dankoff Solar Products, Inc, 1730 Camino Carlos Rey,  
 Santa Fe, NM 87505 • 888-396-6611 or 505-473-3800  
 Fax: 505-473-3830 • pumps@dankoffsolar.com  
 www.dankoffsolar.com

See *The True History of Chocolate*, by Sophie &  
 Michael D. Coe, 280 pages, 2000, ISBN 0-500-28229-3  
 US\$18.95 from Thames & Hudson Inc., 500 Fifth Ave.,  
 New York, NY 10110 • 800-233-4830 or 212-354-3763  
 Fax: 212-398-1252 • info@thames.wwnorton.com  
 www.wwnorton.com/thamesandhudson



# ETAPUMP®

SUBMERSIBLE SOLAR WATER PUMPS

- ☑ up to 650ft lift
- ☑ up to 30 GPM
- ☑ most efficient pump on the market
- ☑ competitive with a generator, even short-term
- ☑ one moving part
- ☑ no motor brushes
- ☑ no electronics in the well
- ☑ maintenance free
- ☑ 4-year system warranty

This is the  
 solar pump  
 you have been  
 waiting for



Call for a dealer referral  
 Toll-Free (888) 396-6611  
 (505) 473-3800  
 www.dankoffsolar.com



## User Friendly Hydro Power



### Alternative Power & Machine

4040 Highland Ave. Unit #H • Grants Pass, OR 97526 • 541-476-8916  
 altpower@grantspass.com

www.apmhydro.com



# Shell Solar

## The fastest route to Kyoto is via Munich.

On Munich's trade fair grounds, Shell Solar and Phönix SonnenStrom AG have made yet another practical contribution to solving the greenhouse problem: on November 26, 2002, the second 1-megawatt solar power system was unveiled. There is ample cause for celebration. After all, the world's largest roof-mounted solar power system produces 2 million kWh each year, reducing annual CO<sub>2</sub> emissions by at least 2,000 tons.

Shell Solar offers you competent support on the way to a future we can all look forward to living in – from engineering services all the way to the turn-key delivery of photovoltaic industrial installations from our team of specialists.

[shell.com/solar](http://shell.com/solar)



# virtually silent

NREL's Wind Turbine Generator System Acoustic Noise Test Report for the Whisper H40 Wind Turbine indicated the difference between the turbine and background noise was between 3 and 7 dBA, a difference imperceptible to the human ear.



# quiet easy

## Certified Whisper Quiet

"The quietest turbine ever tested here" reports the NREL (National Renewable Energy Laboratory). Their acoustic test reports the sound of the Whisper H40 never exceeds background noise by 7 dBA making the H40 virtually silent. To see for yourself, download the full report at

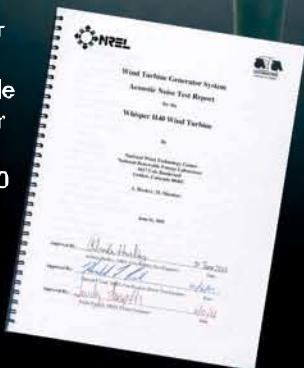

windenergy.com/SUPPORT/downloads.html

## Easy to install...

...and now we have made it even easier with the revolutionary Whisper Tower Kits. Complete installation is possible in just a few hours. Kits include all hardware and easy to follow instructions. These PE Certified (in CA & NE) kits are available in 24', 30', 50', 65' and 80' heights. Visit our web site and download complete manuals at [windenergy.com](http://windenergy.com)

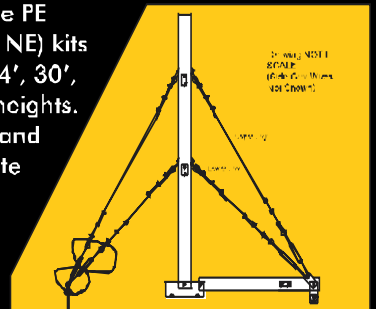

## Southwest Windpower

Renewable Energy Made Simple

2131 N. First Street • Flagstaff, Arizona 86004 USA  
Tel 928-779-9463 • Fax 928-779-1485  
[www.windenergy.com](http://www.windenergy.com) • E-mail [info@windenergy.com](mailto:info@windenergy.com)

### AIR X

400 watt rating  
Newest version of our best selling turbine



\$595 MSRP

### Whisper Nautica

Marine Grade for coastal sites



### Whisper H80

Perfect for low wind areas



### Whisper H80 WP

Low cost 3-phase AC water pumper uses conventional pump technology



### Whisper 175

Over 3000 watts of power



# Unlock Your Battery's Full Potential!

**DeSulfator**<sup>®</sup>  
SULFATION REMOVAL SYSTEM

*"The key to extended battery life."*

**DeSulfator**<sup>®</sup>  
SULFATION REMOVAL SYSTEM

**Every Battery System Needs One!**

**IES** Innovative Energy Systems

Baltimore, Maryland  
410-686-3120 / 410-686-4271 (Fax)  
E-mail: [Info@Desulfator.com](mailto:Info@Desulfator.com)

[www.desulfator.com](http://www.desulfator.com)

# BOOST YOUR SOLAR OUTPUT

- Our most popular SB50L, SB3048L & SB6024HL controllers are ETL listed to UL1741, and CSA/CE requirements.
- Featured in Home Power Magazine  "Things That Work" issue #73 and #77.
- New Solar Boost 6024HL - 24V 60A MPPT Controller with 36/48V PV input.
- Stop throwing away that extra power and use a Solar Boost Maximum Power Point Tracking (MPPT) charge controller.
- Solar Boost charge controllers can deliver up to 30% more power to your batteries over conventional controllers.

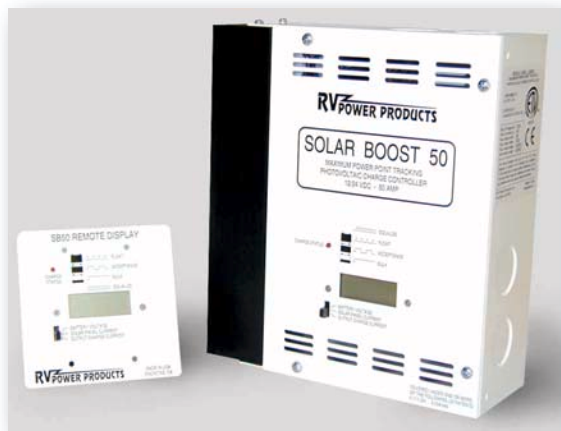

**RV POWER PRODUCTS**  
PROVIDING ELECTRICAL INDEPENDENCE

With Patented SOLAR BOOST™ MPPT Charge Controllers. RV Power Products- The recognized leader in quality MPPT charge controllers. Available in 12/24/48 volt.

Manufactured by RV Power Products and offered by a large network of quality distributors and dealers. Call us today for information or a dealer near you



Visit our web site at [www.rvpowerproducts.com](http://www.rvpowerproducts.com)  
or e-mail to [Info@rvpowerproducts.com](mailto:Info@rvpowerproducts.com)

800-493-7877 or 760-597-1642  
2598 Fortune Way, Suite K, Vista, CA 92083

# PV Done Right—

## Grid Tie, Battery Backup, and System Monitoring

**Brent Simons**

©2003 Brent Simons

The Simons family's PV system covers all their loads—with some green electricity left over to sell back to the utility. State-of-the-art system monitoring shows them how their renewable energy system is performing.

Located in the heart of Silicon Valley, my 4 KW solar-electric system provides all the energy needed to service the electrical loads of my home, and generates a healthy, seasonal surplus that is sold to the local utility company.

I installed the system in January 2002. The main motivations were to be independent of the utility if possible, and to take advantage of the rebate program offered by our municipal utility. Silicon Valley Power's program, at the time, offered US\$4 per watt up to a maximum of US\$16,000. Our total system cost was US\$26,000, resulting in an out-of-pocket cost of US\$10,000. Now our utility administers the California Energy Commission rebate program without adding local money.

### PV System

After performing a load analysis, I determined that a PV system of around 4 KW would easily supply our needs. After reviewing many different solar-electric panel specifications, we decided to use the BP Solarex SX120, 120 watt panels. The main reason was cost per watt. I wanted panels that are aesthetically pleasing, and I liked the blue color instead of the round grey cells that are available. The performance specs of all the polycrystalline panels that I reviewed were about the same, so that was not a large factor.

The system consists of forty panels mounted on the roof of our house. As luck would have it, the front of the house faces exactly south, and no trees or obstacles block the sun. The slope of the roof is 20 degrees, which is optimal for summer, when our usage is highest.

The 24 volt panels are wired in series in groups of two, providing 48 volts for the Trace SW4048 inverter. Our house has a 7 foot (2.1 m) porch overhang in front. This



**Simons System Primary Loads**

Load	Hrs. per Day	x	Watts	=	WH per Day
Fridge/Freezer	8		360		2,880
Lights	4		150		600
TV & stereo	4		350		1,400
Computer	6		250		1,500
Misc.	4		150		600
<i>Total</i>					6,980

proved to be very convenient for mounting the panels. All roof penetrations were in the front roof overhang, so leakage into our home was not an issue.

We used 2 inch lumber to support our PV racks. Since the roof is heavy shakes, we wanted to keep the bolts a little loose so the shakes can expand. The panels are attached to lumber tracks with 1/8 inch (3 mm) thick aluminum clamps that were made at a local sheet metal shop. Wiring from the panel junction box is with #10 (5 mm<sup>2</sup>) wire in 1/2 inch flexible conduit. Plastic, weatherproof boxes with gasketed lids and 1 inch, grey PVC conduit were used to protect the individual panel wires. A flexible 1 1/2 inch conduit carries the PV cabling through a roof jack to the combiner box located in the garage.

The panels are arranged in two arrays of twenty panels each. The output wires from each array are connected to



The power panel is installed in the garage.

**Maui Software's system display screen is loaded with information.**

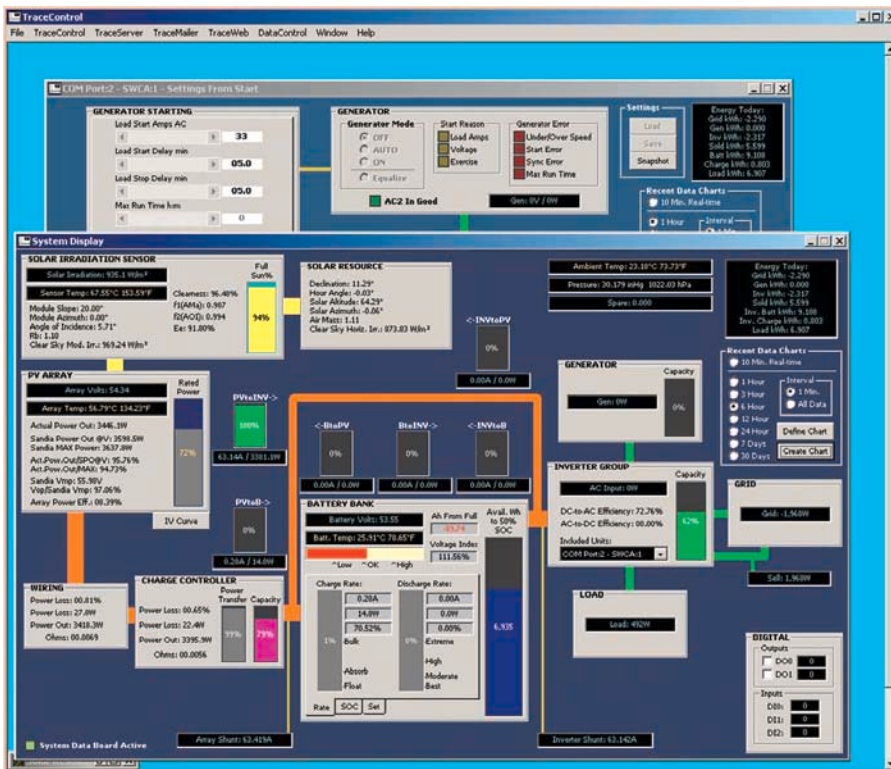

a standard, fused combiner box from Trace. The run from the two combiner boxes to the Trace breaker panel is about 50 feet (15 m). We used #4 (21 mm<sup>2</sup>) cable for the run to minimize voltage drop. There is a 60 amp breaker in each positive PV leg.

**Power Panel**

The power panel consists of a Trace SW408 inverter, two C40 charge controllers with digital displays, a 175 amp battery/inverter breaker and enclosure, PV breakers, and a GFI breaker. The power panel components are attached to a large section of 1 inch (25 mm) plywood that is bolted to several 2 by 4 studs in an accessible corner of the garage.

The electrical code requires that a GFI breaker be provided when PV panels are mounted on the roof of an occupied dwelling. The metal frames



The battery bank provides ample backup to critical loads.

of the PV panels are bonded together with #8 (8 mm<sup>2</sup>) copper wire. All equipment ground wires from the module frames, inverter, and metal enclosures terminate at an isolated wire combiner block. The isolated ground from this block is routed through the GFI breaker to the system's DC negative.

At the power panel, we use two Trace TM500 meters for monitoring purposes—one for battery state of charge, and a second for array output. Both meters are connected to 50 mV/500 A shunts. All system components were ordered from Northern Arizona Wind and Sun in Flagstaff, Arizona. Special thanks to Lisa for her help in making the procurement process go so smoothly. All of the 120 volt house loads were isolated from the main service panel and connected to a new breaker panel. The power source for the house loads breaker panel can be selected from a switch in a second panel that allows either the utility or the PV system to run the house. A third switch panel provides a disconnect for the PV grid tie. The house load panel and grid-tie panels both have 60 amp breakers. If the inverter should fail, it is an easy matter to switch the house loads to regular utility service.

### Battery Bank

After investigating various batteries for backup power, we decided to use the Rolls/Surrette S-530, 400 AH batteries. I wanted batteries with a

good amp-hour rating that did not weigh several hundred pounds. The Rolls/Surrettes provided the best cost per amp-hour ratio. This system uses eight, 6 VDC batteries in series to provide 48 volts to the inverter.

The batteries provide about 10 KWH of storage at 50 percent discharge. They are housed in a vented wooden enclosure. Two small fans are used to vent hydrogen gas to the outside during bulk charging.

### Performance

During the summer months from late April to late August, we have been generating around 24 KWH per day or 720 KWH per month. This has resulted in a surplus of around 150 KWH per month that is sold to the utility.

The summer days were warm, which resulted in the PV panels heating up to between 55 to 60°C (131–140°F). Warm temperatures decrease the output of crystalline PV modules. Even with the reduced output of the panels, plenty of electricity is still available for household needs and to sell.

### Real-Time System Status Monitoring

One important feature of our system is the ability to monitor all performance aspects of the inverter and PV system in real-time. Using a new product developed by Maui Solar Software, we are able to input information from various sensors to measure array temperature; array and inverter current and voltage; battery

The TraceControl screen allows the user to monitor and tweak the inverter.

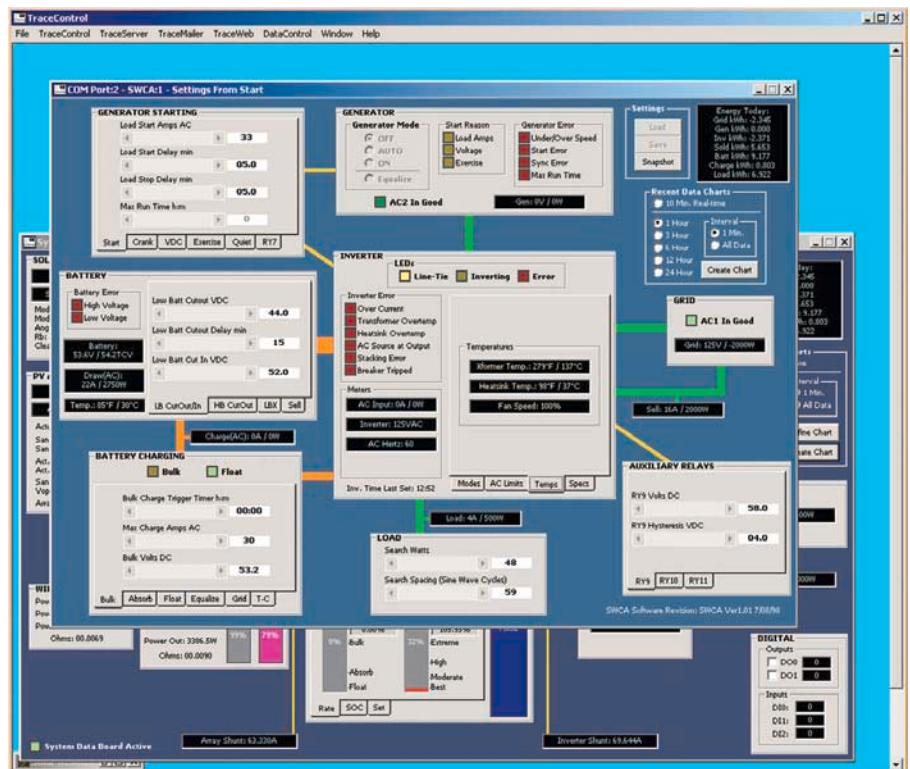

# Simons Family PV System

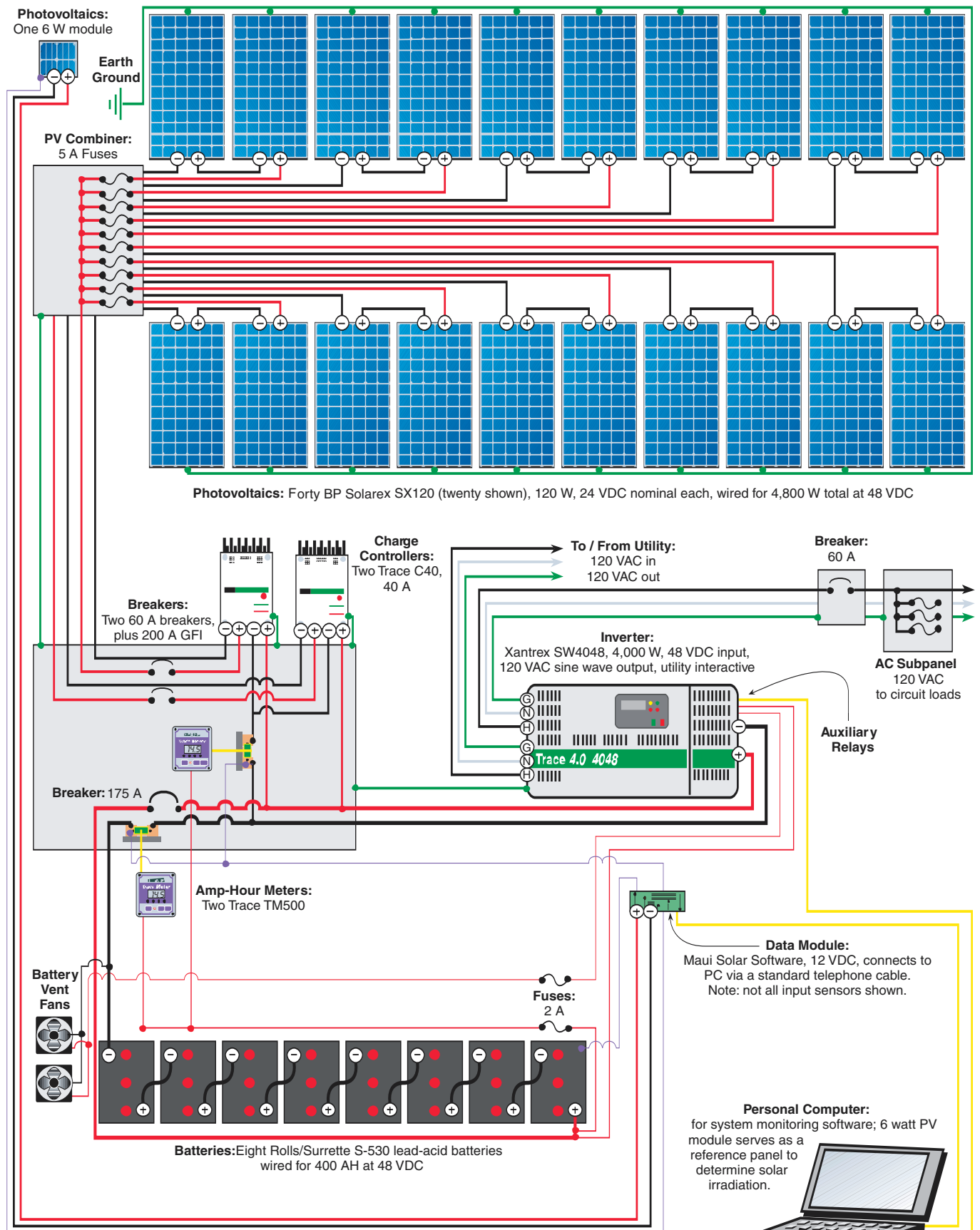

Note: All numbers are rated, manufacturers' specifications, or nominal unless otherwise specified.

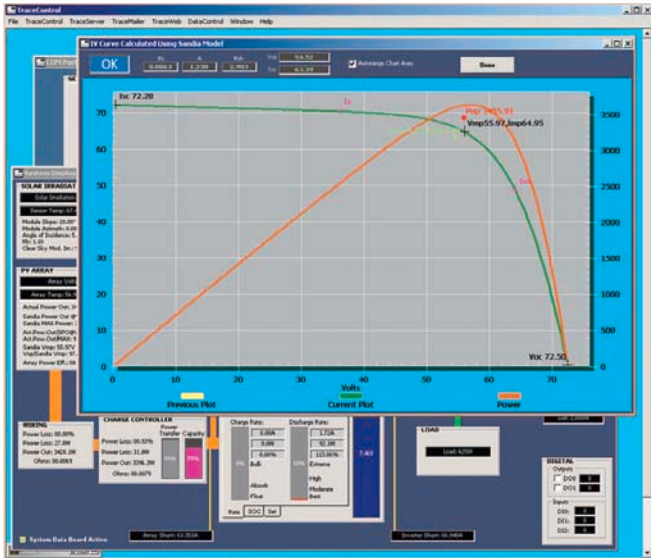

The IV curve screen is based on the system's real-time data.

temperature, voltage, and current; and the temperature and voltage from a small, 6 watt PV module that serves as a reference panel to determine the exact level of solar irradiation in watts per meter squared ( $W/m^2$ ).

All of the sensor inputs are connected to a small data module from Maui Solar Software that is located near the inverter and connects to a PC serial communications port via a four-conductor telephone cable. In conjunction with the Trace SWCA communications adaptor, which also connects to an unused PC com port, a real-time display of all operating parameters can be monitored on the PC. Screen shots of both the TraceControl and Maui system displays appear in this article.

The system display screen (page 23) is showing the current system conditions for noon on October 30. Solar irradiation is measured at  $729 W/m^2$ , while the theoretical clear sky irradiation is  $740 W/m^2$ , with the difference probably due to a slight haze. It can be seen from the display that the PV arrays are operating at 12.42 percent efficiency. The PV panel temperature is  $45.36^\circ C$ , voltage is 55.38 volts, current is 53.121 amps, and the total output from the PV array is 2,941 watts.

The system display screen also shows the wiring loss and charge controller loss values; battery state of charge, temperature, and

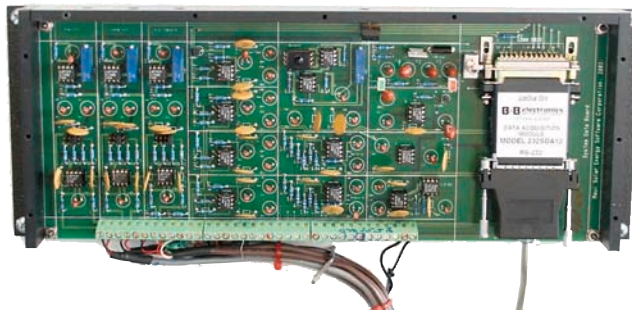

The data module with its cover removed.

## Simons System Costs

Items	Cost (US\$)
40 BP Solarex SX120 modules	\$20,000
Trace SW4048 inverter	2,995
8 Rolls S-530 batteries	1,600
2 Trace TM500 AH meters	396
2 Trace TCB-10 combiner boxes	378
2 Trace C40 controllers	320
Trace PVGFP2 GFI	276
Trace DC175 disconnect	254
Array cables, #4, 120 feet	173
2 Trace C40 digital displays	151
Lumber, 2 by 4s for PV mounts	150
2 Trace DCBB bonding blocks	85
3 Trace BTS-15 batt. temp. sensors	69
2 Trace CD60DC disconnects	63
Battery cables, #2/0 black, 20 feet	40
Battery cables, #2/0 red, 20 feet	40
<b>Total</b>	<b>\$26,990</b>
<b>Rebate</b>	<b>16,000</b>
<b>Grand Total</b>	<b>\$10,990</b>

voltage; and the amount of capacity remaining in the batteries to 50 percent discharge. Other data displayed includes inverter efficiency, sell power, load power, and grid power. The upper right corner of the screen displays the energy produced and sold for the day.

The screen shot of the TraceControl panel (page 24) in Maui's software shows the current operating conditions for the Trace inverter. As can be seen on the screen, the system is producing at 2,750 watts. The inverter internal transformer and heat sink temperatures are displayed, as well as all fault and status lights.

All inverter set-up values can be entered from the TraceControl program, and they are stored as a profile in memory. The profile may be easily loaded into the inverter from the program settings menu if the inverter operating parameters need to be changed or reloaded. All inverter display functions can be plotted from the "recent data charts" menu.

One of the features of the system display software is the ability to model the PV arrays in the system using

the Sandia National Laboratories PV module library. An IV and power curve is displayed in a separate window showing the theoretical IV and power curve for the system PV arrays at their actual operating current and voltage (page 26).

The program superimposes the actual array performance on the IV graph (red and green dots) to allow monitoring of real-time system performance throughout the day relative to predicted performance. Data setup for the system includes latitude and longitude, and array tilt and azimuth to allow real-time sun position prediction.

The data module board collects the inputs from various external sensors—shunts, system voltages, system temperatures, and solar irradiation reference panel—and conditions them for the analog to digital (A/D) converter module. I have been working with Mike at Maui Solar Software on the testing and debugging of the board and software. My system has been used for the engineering development of the monitor board and software. Contact me if you have questions about the system.

**Reliability & Independence**

After 35 years as an electronics engineer working with military and commercial RF systems, I have had a huge amount of fun designing and installing my own PV system at my home. My wife and I have been operating the PV system for more than twelve months, and it has been great. We may want to move to a mountaintop someday and our experience with this system will allow us to be anywhere we want without worrying about utility service availability.

Since the PV panels are on the front of our house and visible from the street, we have had many people ask what they are for. It is interesting to see the surprised looks when I tell them that we supply almost all of our electricity from the sun.

Everyone who has seen the system is amazed that it is possible to do this. I have had several converts who are contemplating installing their own home PV systems. Most people that I have talked to who are nontechnical think that you have to be a rocket scientist to install and operate a PV system for your home. We're trying to show our friends and neighbors that solar electricity is user friendly and attainable.

**Access**

Brent Simons • b\_Simons@pacbell.net

Northern Arizona Wind & Sun, 2725 East Lakin Dr., Flagstaff, AZ 86004 • 800-383-0195 or 928-526-8017  
 Fax: 928-527-0729 • windsun@windsun.com  
 www.windsun.com • System components



**Brent Simons throwing the switch at the AC service panel.**

Silicon Valley Power, 1500 Warburton Ave., Santa Clara, CA 95050 • 408-244-7283 • Fax: 408-244-2990  
 cutcosts@siliconvalleypower.com  
 www.siliconvalleypower.com

Maui Solar Software, Mike Pelosi, 810 Haiku Rd., #113, Box 1101, Haiku, HI 96708 • 808-876-1859  
 sales@mauisolarsoftware.com  
 www.mausolarsoftware.com



**New Improved  
PowerCenter Featuring  
"Slow Mode" Rotor Speed Control**

# BERGEY XL.1

## 1000 Watt Home Wind Turbine

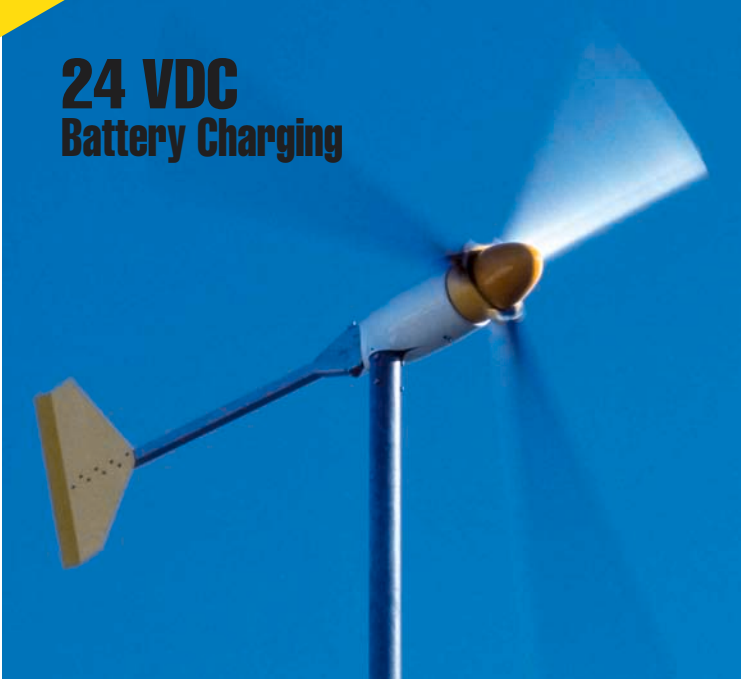

**24 VDC  
Battery Charging**

### Features

- ◆ 5-Year Warranty (Industry's Longest)
- ◆ Low Noise Under All Conditions
- ◆ Bergey "Tornado-Tuff" Ruggedness
- ◆ Advanced Airfoil and Oversized Neo Alternator
- ◆ AutoFurl "No Worry" Storm Protection
- ◆ Fail-Safe Design, No Dump Load Required for Structural Safety
- ◆ Upgraded Multi-Function Microprocessor Controller (new)
- ◆ Boost Converter Provides Charging at 6 mph
- ◆ New "Slow-Mode" Idles Rotor When Batteries are Full
- ◆ Push Button Electric Brake (new)
- ◆ All-Inclusive Tilt-up Towers: 30', 42', 64', 84', and 104'
- ◆ Tower Winch System using Hand Drill Power
- ◆ Installation & Support by Over 500 BWC Dealers

The Bergey XL.1 24 VDC battery charging wind system is the most technically advanced small wind turbine on the market today. It provides superior energy production performance with the "Tornado Tuff" ruggedness that has made Bergey turbines best sellers since 1980. And, best of all, the XL.1 is value priced to give you the most bang for your buck.

The XL.1 now features an upgraded PowerCenter controller that idles the rotor once the batteries are full (Warning: Be prepared to spend hours flipping lights on and off to cause the rotor to speed up or slow down. Highly addictive to techies.) and provides a convenient push button brake function. In addition, we doubled the dump load capacity (to 60A) and gave it proportional (PWM) control to more accurately maintain battery voltage, added a "wattmeter function," made customizing set-points a snap, and added a polarity checker for the wind and PV inputs.

Compare features, performance, price, reputation, and warranties. We think you will find that the Bergey XL.1 is the clear choice for your home power system. Get product information and find a dealer near you by visiting our web site: [www.bergey.com](http://www.bergey.com).



**PowerCenter Controller**

- 60A Wind Regulator
- 30A Solar Regulator
- 60A Dump Load Control Circuit
- Voltage Booster for Low Winds
- Battery and System Status LEDs
- "Wattmeter" LED Function
- Timed Equalization Function
- Push Button Rotor Brake
- Slow Mode Rotor Idling
- Easy Set-Point Adjustment
- Polarity Checker

## Typical Performance: 5.2 kWh DC per day

4 Times More Energy Than the Air 403<sup>1</sup>

1.8 Times More Energy Than the Whisper H40<sup>2</sup>

1-Air is a registered trademark of Southwest Windpower, Inc.  
2-Whisper is a registered trademark of Southwest Windpower, Inc.

11.2 mph (5 m/s) Average Wind Speed at Hub Height, Rayleigh Distribution.  
Based on manufacturer's published power curves.



**SIMPLICITY • RELIABILITY • PERFORMANCE**

**2001 PRIESTLEY AVE.  
NORMAN, OK 73069  
T: 405-364-4212  
F: 405-364-2078  
SALES@BERGEY.COM  
WWW.BERGEY.COM**

# ALTERNATIVE ENERGY ENGINEERING

SINCE 1979

## RENEWABLE ENERGY DEALERS & INSTALLERS:

We offer great service, excellent technical support, only the best equipment, and of course, all of the familiar faces.

Let us help you bring

# Power To The People



### ***We Stock:***

*Shell Solar Modules  
Whisper Wind Generators  
Morningstar, RV Power and  
Xantrex Charge Controls  
Exeltech, Xantrex, SMA and  
Samlex Inverters  
Disconnects and Combiners for  
Grid Connected Instalations  
Shurflo and Flojet Pumps  
ES&D and Harris Hydro*

**WHOLESALE ONLY**



**1155 Redway Drive - Box 339  
Redway, CA 95560  
888-840-7191 / 707-923-2277  
FAX 707-923-3009**

***info@alt-energy.com • www.alt-energy.com***

### ***We Manufacture:***

*Digital Volt & Amp Meters  
Battery & Inverter Cables  
Inverter Bypass Switches  
Highlifter Water Pumps  
12 and 24 Volt Lighting  
MultiContact Cables  
DC and Solar Fans  
Air 403 Shutoffs*

# ALTERNATIVE ENERGY ENGINEERING

# Are Subsidies the Answer?



Mark W. Wilkerson

©2003 Mark W. Wilkerson

Photo—Mark Segal Photography

Chicago's lights at night are beautiful, but are they sustainable?

It might be beautiful to get half of your RE system paid for with government subsidies, but is that sustainable?

**W**hat would you say is the single most compelling reason for individuals on “Main Street, U.S.A.” to buy a solar-electric system? By mainstream, I mean Joe Homeowner, in the city or the suburb, not the off-grid person who knows RE makes economic sense. In my 19 plus years of selling solar-electric systems, I can tell you what that reason is—fear!

The two biggest growth spurts in the domestic photovoltaic market occurred with:

- Y2K, accompanied by fear of the grid going away forever, and
- California's energy crisis of 2001, accompanied by the fear that grid electricity might never be stable again.

The fears never materialized, but PV sales soared.

As German and Japanese subsidies kicked in, sales also soared to the point of product shortages here in the U.S. over the past five years. It is certainly not a hard sell when a solar-electric system not only pays for itself in less than ten years, but also actually generates positive cash flow, as in Germany. So with no impending crises, you might expect the rising tide of U.S. subsidies to be lifting the photovoltaic market to new heights. Yes and no.

## RE Paradise?

It's no secret that grid-connected PV installations represent the single highest growth segment of the industry. Today in the U.S., one state could be considered an RE paradise, and should be sharing in this growth. Easy rebate money is available for homeowners on solar and wind-electric systems—it pays for 50 percent of a system costing up to US\$10,000 (a US\$5,000 rebate). Not so easy, but incredibly generous grants exist to cover up to 60 percent of the total installed price up to US\$300,000. The homeowner can actually receive up to 90 percent of this grant money *up front*.

Add to this mix of RE incentives, the absolute easiest net metering program in the country, which allows for grid connection in less than a week after a short form is completed, and one phone call to the utility. You might expect the RE business climate to be booming, right?

This scenario of an investor owned utility (IOU) that provides customer funded, state administered generosity actually is alive today in, not Florida, not California, but Illinois of all places. I am in a front row seat for this activity, since I received the first rebate issued in the state for my small PV system with battery backup. My colleague, Steve Bell, received the first grant administered in the state (see *HP77*). The rebate allowed me to afford my first system after fifteen years of wanting one! But I'm not sure that subsidies are the best incentive.

## A Disappointment

Everyone—from the Illinois Department of Commerce and Community Affairs (DCCA) to ComEd Excelon, the



IOU behind the great net metering program, to solar distributors and dealers alike—would agree that Illinois’ incentives, while most generous, have been most disappointing if measured by numbers of installs.

It’s not that the Illinois program hasn’t generated interest—oh no, far from that. Denise Bechen, program manger for ComEd’s wind and PV net pricing experiment says that they have received more than 3,000 inquiries from very interested people. Some were so impatient to receive information that they raised all sorts of ruckus because they were not getting attended to fast enough. But did they buy? No, not for the most part.

Since the program began in April 2000, only twenty-five people in ComEd’s territory have applied for and received the ability to net meter. Only fifty home systems have been installed since the grant and rebate program began. This is fifty out of many thousands of inquiries at the DCCA office. Every time California was in the news with a new blackout warning, there was a resurgence in interest, not just from Illinois, but from every state in the country. The false interest became so stifling that Steve Bell who works in my office had to come up with a table that helped people understand just how much money they would save (or rather *not* save) with every kilowatt of PV they installed.

Yes, the interest was there, but I call it false interest. The only reason people are interested is because of the media-led impression that solar-electric systems can save them money due to “advancements” in the



Photo—Almand Brothers

**A solar powered arrow board, seen on every highway. These little beauties displaced 10,000+ diesel gensets! No subsidies were needed for this natural market—the largest in North America.**

**Average Monthly Savings on Electric Bill per KW of PV**

City	Sun Hrs. <sup>1</sup>	KWH per Day <sup>2</sup>	Utility Electricity Costs per KWH (US\$) <sup>3</sup>						
			\$0.08	\$0.10	\$0.12	\$0.14	\$0.16	\$0.18	\$0.20
Albany, NY	4.05	2.90	\$6.96	\$8.70	\$10.44	\$12.18	\$13.92	\$15.66	\$17.40
Chicago, IL	4.60	3.34	8.02	10.02	12.02	14.03	16.03	18.04	20.04
Denver, CO	6.06	4.53	10.87	13.59	16.31	19.03	21.74	24.46	27.18
Houston, TX	4.78	3.39	8.14	10.17	12.20	14.24	16.27	18.31	20.34
Kansas City, MO	5.01	3.65	8.76	10.95	13.14	14.24	16.27	19.71	20.34
Los Angeles, CA	5.84	4.31	10.34	12.93	15.52	18.10	20.69	23.27	25.86
Miami, FL	5.18	3.69	8.86	11.07	13.28	15.50	17.71	19.93	22.14
Phoenix, AZ	6.63	4.79	11.50	14.37	17.24	20.12	22.99	25.87	28.74
Richmond, VA	4.65	3.34	8.02	10.02	12.02	14.03	16.03	18.04	20.04
San Francisco, CA	5.76	4.27	8.03	12.81	15.37	17.93	20.50	23.06	25.62
Seattle, WA	3.97	2.84	6.82	8.52	10.22	11.93	13.63	15.34	17.04

1. Sun hours are based on the PV array tilted at the best, fixed angle to provide the highest annual energy output.  
 2. KWH per day is the average daily energy delivered to the grid, based on 90% inverter efficiency, & 12% system losses.  
 3. For higher utility costs, add the savings of lower rates together. For example, for San Francisco at \$0.38 per KWH, add the \$0.18 per KWH savings (\$23.06) and the \$0.20/KWH savings (\$25.62) to equal \$48.68.

technology. It can save them money, but the amount saved versus the ridiculously low price of energy they are accustomed to (even if it doubles or triples) does not make for a savvy investment of their income if dollars are the only measure.

### Subsidies Do *Not* Equal Incentives

From the viewpoint of a fiscal conservative who earns his living in the PV industry, selling to the natural (nonsubsidized) markets, this program is proof positive that subsidies are *not* the answer. Artificial incentives simply will not create a sustainable, thriving RE business for the long term any more than a business plan built on such subsidies makes for an attractive investment, long term.

Subsidies imply that products do not have the merit or value to stand on their own in the marketplace. This reliance on subsidies is therefore not a sustainable means to creating a market that can thrive without them.

Perhaps there is nothing wrong with such a dependence if we could be assured that the subsidies would never disappear. However, in the late 1970s, a solar heating industry was born of subsidies, and it promptly died when the subsidies ceased. Rather than curse former President Reagan for doing away with the subsidies, we ought to curse the solar sales people who were selling US\$2,000 systems for US\$4,000 (1970s dollars). They were actually selling 40 percent tax credits, not solar equipment. As states grapple with tightening budgets, I sure would not be comfortable building a business based on the subsidized marketplace.

If a product or technology cannot stand on its own, it should in fact not stand. But when you redefine subsidies to include things like the cost of going to war to protect oil or the cost to the environment to keep coal plants operating, then we must all insist on a level playing field before determining what products or technologies have the intrinsic value to stand or fall on their own.

Instead of subsidies, what we need is a true and fundamental paradigm shift among the population. It could be facilitated by a much less reliable electricity supply, or *much* higher energy costs (US\$0.30–0.40 per KWH), or some mix of both. High electrical costs, plus a measure of unreliable supply equals great PV business.

### Reliability

Lower reliability of utility electricity supply is part of the answer. Whether reliability suffers from terrorists' acts or deregulation, when the grid becomes less reliable, the value of PV and other renewables will increase.

Maybe we should encourage the construction of so many gas-fired power plants that there simply is not

enough gas to run them, and allow the reliability issue to take care of itself. Oh, I think that's already happening. I have faith in the politicians and bureaucrats—less reliability will not need encouragement!

### Stop Subsidizing Dirty Energy

Assuming that the goal is a thriving, sustainable RE industry, we need much higher energy costs. According to Friends of the Earth, Taxpayers for Common Sense, and the Public Interest Research Group, the energy giants today will receive US\$26 billion in subsidies, direct from you, the taxpayer, over the next five years.

Through quite an array of subsidy mechanisms, these polluting energy companies (oil, gas, coal, and nuclear) will receive more in subsidies than ten times the value of the entire worldwide photovoltaic industry combined. Even with these subsidies, energy costs are rising.

If you want to be an activist, I suggest first a call to action. Demand that politicians, especially the "pork hating Republicans," be true to their word and create smaller government by eliminating all of these

**Although not completely off-grid,  
the author's family makes about 40 percent of its own  
electricity, thanks to Illinois rebates.  
He doesn't mind the higher price of PV-generated power.**

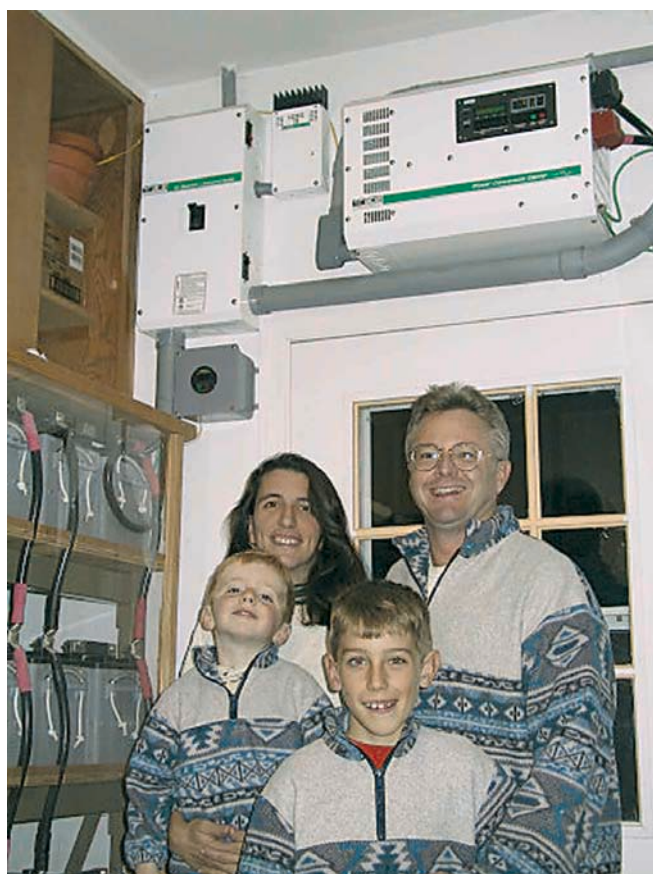

subsidies to industries that seem to be reporting record profits these days. Sure, if they want to cut RE, do so. But they had better cut *all* the other energy subsidies as well.

An extension of this effort might be to tax fossil fuel energy to make up for the years of subsidies that have created artificially low energy prices. To do this, we would have to start a campaign that would grow to monumental numbers of individuals, corporations, environmental groups, nonprofits, etc., all demanding higher energy prices.

Can you imagine a politician running on the platform of much higher energy prices? Is this realistic? I seriously doubt it. As a matter of fact, I believe this is impossible. Very few individuals and even fewer politicians would succeed in making this a winning referendum.

**Buy RE Anyway**

OK, if we're going to forget a mass protest for higher prices, how can we move toward higher energy prices? After pushing for the removal of dirty energy subsidies, the most realistic way to pay more for energy, right here, right now, is to invest our own money in our own RE systems. I've always used the ballpark figure of US\$0.30 per KWH over a thirty year system life for energy costs of a generic PV system.

If you sit still, close your eyes, breathe deeply, and ground yourself into a peaceful state of inner knowing, you will realize that we do need much higher energy prices to balance the decades of fossil fuel dependence. It feels like truth, no matter how much your head and wallet want to protest. And you can make it happen for yourself!

One thing is for sure, a major paradigm shift is needed and seems poised to happen. Most Americans simply will not buy solar-electric systems out of the goodness of their hearts to help the planet. There are too many other priorities, such as educating the kids, putting food on the table, or buying that home theatre system.

The right mix of personal choices, higher energy costs, and less reliability could turn these priorities upside down. Maybe a paradigm shift of this magnitude will see neighbors showing off their PV systems rather than their new cars or stereos... I hope it happens sooner rather than later.

**Access**

Mark W. Wilkerson, Center for Sustainable Community, VP of Business Development, SunWize Technologies, Stelle, IL, 60919 • 800-683-4837 ext. 22  
 Fax: 815-256-2221 • mwwpv@stelle.net  
 www.sunwize.com • www.stellecommunity.com

Steve Bell, SunWize Technical Support Specialist, 141 Tamarind Ct., Stelle, IL 60919 • 800-683-4837, ext. 23  
 Fax: 815-256-2221 • sebpv@stelle.net  
 www.sunwize.com

Denise A. Bechen, Program Manager, Wind and Photovoltaic Generation Programs, ComEd Energy Delivery Operations Center, Marketing Technical Services, 2nd Floor (02-NE-025), 3 Lincoln Centre, Oakbrook Terrace, IL 60181 • 630-576-6783  
 Fax: 630-576-6353 • Denise.Bechen@exeloncorp.com  
 www.chicagosolarpartnership.org

Rex Buhrmester, Illinois Department of Commerce and Community Affairs, (DCCA), Renewable Energy Resources Program (RERP) • 217-557-1925  
 Fax: 217-785-2618 • rbuhrmes@commerce.state.il.us  
 www.commerce.state.il.us/com/energy/alternate.html



**African Wind Power**  
**"Built to Quietly Last"**

Strong as an elephant, but not quite as heavy.

Distributed by:  
**Abundant Renewable Energy**  
 www.AbundantRE.com  
 22700 NE Mountain Top Rd.  
 Newberg, OR 97132  
 (503) 538-8298  
 Fax (503) 538-8782

# Solar Energy International

Contact us for a workshop schedule  
or visit our website.



Strawbale Construction

## Upcoming Workshops:

### In Colorado

Contact SEI for our complete workshop schedule

### PV Design & Installation Outside of Colorado

Summertown, TN	April 14-19
Woodstock, NY	April 21-26
St. John, USVI	April 28-May 9
Grass Valley, CA	March 10-15
Austin, TX	March 24-29

### Women's Workshops

Wind Power, Custer, WI	June 9-14
PV Design & Installation, Paonia, CO	July 7-18
Carpentry, Paonia, CO	July 21-25

### Other Workshops Outside Colorado

Biodiesel Fuel, Cleveland, OH	May 5-9
Biodiesel Fuel, Missoula, MT	Aug. 18-22
Natural House Building, Kingston, NM	Sept. 29-Oct. 3

### San Juan Island Series on Guemes Island, WA

Intro to Renewable Energy Systems	April 5
PV Design & Installation	April 7-12
Micro-Hydro Power	April 21-24
Homebuilt Wind Generators	April 14-19

### Distance Courses on the Internet

PV Design	August 4- Sept. 12
-----------	--------------------

### Workshops:

Introduction to  
Renewable Energy  
Photovoltaics Design  
& Installation  
Photovoltaics 2  
PV Design On-Line  
Distance Course  
Utility Interactive  
Solar Systems  
Wind Power  
Microhydro Power  
Solar Home Design &  
Natural House Building  
Solar Home Design On-Line  
Distance Course  
Strawbale Construction  
Solar Water Pumping  
Solar Hot Water  
Renewable Energy for the  
Developing World  
Successful Solar Business  
Biodiesel Fuel  
Women's Photovoltaics  
Women's Wind Power  
Carpentry Skills for Women  
The Politics of Energy  
Homebuilt Wind Generators

### Women's Wind Power



**Hands-On Education • Sustainable Development**

voice: (970) 963-8855 • fax: (970) 963-8866

e-mail: [sei@solarenergy.org](mailto:sei@solarenergy.org) • web: [www.solarenergy.org](http://www.solarenergy.org)

P.O. Box 715, Carbondale, Colorado, USA 81623

# No Power? No Problem!

**There is more to a working renewable energy system than a cheap deal on a pile of hardware.**

## ***We Provide:***

Complete service. We do solar, wind, microhydro and pumping systems. Load analysis, site survey, system design, sales, installation, user training, and tech support long after the warranties expire. We live on renewable energy, have 20 years of experience, and have established over 500 systems. We specialize in NEC® compliant, safe systems that will make your Electrical Inspector smile!

Equipment for DIY. We offer reasonable deals and technical reality checks. Why settle for a packaged system when you can have yours custom designed by an expert?

Your best resource is a local pro. Tap into our network of qualified, competent Electron Connection associates across the country.

Going into the Biz? Why talk to a "sales technician" when you can talk to an electrician? We KNOW what works and how it works. We offer technical support, system design help, prompt shipment, fair pricing and NO BULL. Local referrals always. Electrical competence required.



# **Electron Connection**

CA Electrical Lic #613554  
OR CCB Lic#149724

# 800-945-7587 toll free

# www.electronconnection.com online catalog



PO Box 203, Hornbrook, CA 96044 USA

Voice / Fax: 530-475-3401 • E-mail: [econnect@snowcrest.net](mailto:econnect@snowcrest.net)

# The Solar Decathlon

## Solar Houses for Today



Zeke Yewdall & Catherine Buxton

©2003 Zeke Yewdall & Catherine Buxton

Solar homes were shining on the National Mall in Fall 2002. The Solar Decathlon set some new examples for home building and brought fourteen teams together to share knowledge and compete.

Imagine fourteen solar homes planted on the National Mall in Washington, D.C. Teams of university students display their best energy efficient home designs, competing with each other while learning from each other. Thousands of people cruise the mall, learning about energy efficiency and renewable energy. Even a few Congressional representatives and staff see that solar energy works. Pipe dream? No, it's the Solar Decathlon!

The Solar Decathlon is a new Department of Energy (DOE) event where colleges and universities compete to design and build the best solar powered house. The

first competition was held from September 19 to October 9, 2002 on the National Mall, between the Capitol building and the Washington Monument. Fourteen teams competed in this first event. Most teams consisted of a mix of architecture and engineering students.

The houses were limited to 800 square feet (74 m<sup>2</sup>) maximum footprint, with at least 450 square feet (42 m<sup>2</sup>) of conditioned space. They could use only the energy of the sunlight falling on them. They were transported to Washington, D.C. from all over the country (including Puerto Rico), set up in a temporary solar village on the mall, and monitored to see which ones performed best. All houses had stand-alone electrical systems. The idea was to create a solar house that could maintain all of the elements of the American lifestyle.

BP Solar, Home Depot, Electronic Data Systems (EDS), the American Institute of Architects (AIA), and the National Renewable Energy Lab (NREL) were national sponsors for this event. Each team was responsible for

## The Ten Contests:

In the original Greek Pentathlon, athletes competed in contests of physical strength and endurance, as they do in its successor, the modern Olympic Decathlon. The Solar Decathlon is a contest of ingenuity and design instead of athleticism, and consists of ten contests. Each contest, with the exception of Design and Livability, was worth 100 points.

1. Design and Livability: This competition had twice the weight of each of the others, and was decided by a panel of architecture judges.
2. Design Presentation and Simulation: The structural drawings and computer simulations of performance were evaluated by a panel of engineers.
3. Graphics and Communication: Each team conducted tours, published a Web site, and wrote and distributed newsletters, which were judged on content and effective presentation.
4. Comfort Zone: NREL staff monitored temperature, humidity, and energy use of each house. A panel of

engineering judges considered consumer appeal, innovation, and integration.

5. Refrigeration: NREL staff looked for adequate temperatures in the fridge and freezer, and an engineering panel judged refrigerator innovation.
6. Hot Water: Having an adequate supply of 120°F (49°C) water for showers, dishwashing, and washing machine was the goal here.
7. Energy Balance: The houses had to generate as much electrical energy during the week as they consumed.
8. Lighting: The houses had to be well lit through a combination of electric lights and daylighting.
9. Home Business: Each house was required to run a computer and printer to produce daily newsletters and respond to e-mail.
10. Getting around: Each team used an identical Ford Th!nk Neighbor to drive around town, and the maximum number of miles won.

raising all of the funds needed to compete. The teams had two years from the request for proposals to the time of the competition. Once the teams arrived on the Mall, they had nine days to assemble the homes before the first tours.

### The Turnout

The contest drew an estimated 100,000 people to the National Mall over the two weekends the houses were open for tours. Hundreds of people stood in long lines to get a tour of the most popular houses. Hometown newspapers carried frequent updates on the progress of their towns' teams. Fox, C-Span, and others carried live TV coverage of the event. Architecture and engineering

students, not used to being in the limelight, achieved what seemed to them like rock star status. Indeed, the event has been called a solar Woodstock.

The turnout was not limited to the general public. The Secretary of Energy, Spencer Abraham, spoke at the opening ceremonies, and toured several of the houses during the competition. Word has it that he was so impressed during his official tour that he came back the next day with his whole family. Several senators and representatives came down to cheer on their favorite teams. Notably absent was the President, who didn't show, despite two of his home state's schools being represented.

## The Teams & Homes

### Auburn University

Auburn incorporated old and new design ideas into their house. It was an effective synthesis of the traditional southern "dogtrot" design (separate house sections connected by a walkway) and new technologies like solar electricity and passive solar heating. A sundial in front of the house represented one of the oldest and most visual technologies that uses sunlight.

Inside, the team used "solar megaphones" (skylights filled with prisms that amplify sunlight for daylighting), which are the most efficient source of solar daylighting on the market. The house is aesthetically pleasing and functional. Large water-filled cylinders decorate the rooms of the home and also moderate the house's temperature. The water acts as a thermal mass that helps the home stay cooler in the summer and warmer in the winter.



### Carnegie Mellon University

This house was designed to be an urban row house in Pittsburgh, where it would be rebuilt and donated to a needy family after the competition. Because space is at a premium in the city, the team decided that it would not be viable to build a one-story, 800 square foot (74 m<sup>2</sup>) house, as the competition rules suggest. This team felt that two-story houses are a much more efficient use of space. So even though it resulted in losing 48 points in the competition, they built the house that was best for its final destination. In keeping with the urban design, a large rooftop deck contains a garden under a canopy of evacuated tube hot water collectors.



Galen Burrel—University of Colorado



Zeke Yewdall—University of Colorado

### Crowder College

Can a two-year technical school in rural Missouri compete against the best schools in the nation? You bet! Crowder's winning solar car team went for bigger goals this year. They constructed their solar powered house using electricity from their portable solar trailer, on their campus and at the mall—the only school that didn't use a gasoline generator for construction on the mall! No diesel powered cranes or forklifts were used in the construction either. They were the only team who off-loaded their house completely with hand cranks and jacks.

The Crowder team was also different in their use of solar energy. They used amorphous thin film, BP Millennia photovoltaic modules, instead of crystalline silicon modules like other teams. The modules were integrated into a standing seam metal roof so you could barely tell they were there.

Crowder's unique water heating system used the waste heat from their PV modules. A system of copper tubes was attached to the back of the modules, and an extra layer of glazing was added above the modules. This effectively turned each module into the absorber plate of a flat plate solar water heating collector.

### University of Colorado at Boulder

Colorado set out to destroy many of the notions of what is "required" for a solar house. The roof is almost 20 degrees flatter than the optimum slope (see *PV Orientation* by Zeke Yewdall, in *HP93*), and part of it faces southwest. Their hot water collectors are flat, but have tilted absorber plates in the evacuated tubes. Another guiding theme was that everything in the house is commercially available and mass produced.

The house is light and pleasant inside, and the main kitchen/living room feels very large. The team had trouble keeping people out, or keeping them from plopping down on the couch during tours and just staying!



Michael Wassmer—University of Colorado



Warren Getz—NREL

### University of Delaware

The University of Delaware's house was the only semicircular house on the mall. Not only was this shape reminiscent of the school's initial, "D," it also allowed the sun to enter the house at all times of the day. The house's inhabitants could sit and watch the sun travel across the sky without moving from their seats.

The Delaware house features a Warmboard panel radiant floor heating system. This system integrates fluid piping into a plywood underlayment, with aluminum sheeting that helps to distribute the heat. Unlike concrete, this system can be implemented on any floor of a house, since it is not much heavier than an average floor.





Michael Brandemuehl—University of Colorado



Warren Gretz—NREL

The solar home teams that entered the Solar Decathlon in Washington, D.C. had to first build their entries at their campuses or off site, and then ship them to the National Mall where the contest was held.

Here are two construction photos of University of Colorado at Boulder putting their entry's structurally insulated panel (SIP) walls together in the parking lot of Home Depot, an event sponsor.

### University of Maryland

Maryland's key goal was to produce a house that did not appear to be a solar house. Except for the well-integrated PV array on the back roof, their house looks like it would fit right into any housing development. It uses a skylight and bay window for natural lighting, an electric daylight dimming system, and super efficient, off-the-shelf appliances. Maryland also excelled in their hot water system design. The system provided both domestic hot water and hot water for the radiant floor heating system.

Because they only had to transport the house 15 miles (24 km), they were able to use a poured slab concrete floor, which allows high efficiency radiant heating to be used. They also had a large north deck that made the house feel much larger than the actual interior size of 600 square feet (56 m<sup>2</sup>).

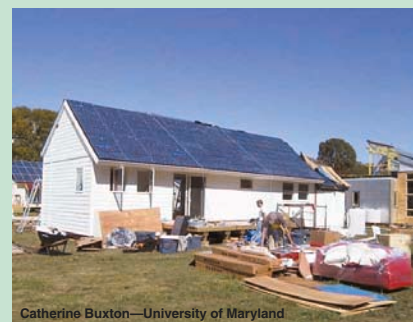

Catherine Buxton—University of Maryland



Warren Gretz—NREL

### University of Missouri at Rolla/Rolla Technical Institute

Rolla Missouri's team wanted to build a house that the average consumer would accept as comfortable and familiar. They felt that a futuristic house might scare people away from using solar energy. Their traditional ranch home was transported in three sections that were each mounted on trailer frames.

The house is very cozy and comfortable—anyone would feel right at home when walking in. The Rolla Technical Institute students contributed their skills by building the cabinetry, shelving, and deck. The engineers from UMR designed the house, including the sun room on the south side of the house. This sun room contains all of the controls for the house, and its floor is tiled with the names of the team's sponsors.



### University of North Carolina at Charlotte

A small, but very dedicated, team of architects built this house. It was unique in that it used only 120 volt appliances, and one 4 kilowatt inverter. Most of the appliances are from the yacht industry. They are smaller than normal, and use less energy than their traditional counterparts—perfect for a small solar house.

The house also uses Kalwalls (an insulated translucent fiberglass product that lets in 10 percent of the sun's light) to provide added daylighting. Skylights and creative lighting schemes made the house's interior more interesting.

### University of Puerto Rico

Of all the teams, Puerto Rico had the biggest travel challenge. They had to pack their house up in shipping crates, load it on a barge, and send it off to Washington. For that reason, they had less time to work on their house before bringing it to the mall.

This team was made up of architects from one campus on the island and engineers from another campus. They had never worked together before, and they not only had to tackle the issue of transportation, they also had to build a house for a climate that they had never lived in. Working together with area manufacturers, they researched the weather in Washington, D.C., and built an effective house with the resources they had.



### Texas A&M University

Texas A&M is one of the top construction science schools in the country, so they wanted to focus most of their design's attention on cutting-edge construction techniques in relation to solar energy. The team actually set out to not only show the consumer that using solar energy was possible, they were also targeting contractors and builders.

One interesting technology implemented in this house was the interior wall of water. Based on refrigeration technology, the team used water running through pipes in the wall to moderate the temperature of the house. This team also designed their own refrigeration system for the kitchen. Unfortunately, Texas A&M did not participate in the bulk of the competitions because student representatives were unable to be present during the competition week.

### University of Texas at Austin

Perhaps the most intriguing house at the competition, this house started as an Airstream trailer and hundreds of parts that looked like a giant erector set. Slowly, columns, the roof, and finally the walls, emerged from the seeming chaos and became a house. This team used the trailer as part of the house, so that when the owners want to go on vacation they can take their home with them.

The Airstream trailer housed all the "wet rooms" of the house like the kitchen and bathroom. The land-anchored house sections were the living room, office, and bedroom. Between the trailer and land sections of the house runs a breezy deck area where a Texas homeowner could enjoy the great outdoors.



**Tuskegee University**

This house is an adaptation of the traditional southern “dogtrot” design with an open breezeway down the center of the house for natural ventilation. It was the only two-story house in the competition that was under the 18 foot (5.5 m) height limit—quite a feat.

The house is heated by passive solar energy, with an air source heat pump backup. There is an air conditioning system if needed, but the house is also designed for maximum natural ventilation, with a north-facing balcony. Education has been a key portion of Tuskegee’s mission in this competition. The house was designed to be a beautiful addition to the campus and will form the core of a new renewable energy center that is being developed.



Warren Gretz—NREL



Warren Gretz—NREL

**University of Virginia**

The University of Virginia’s goal was to create a house that appealed to the experimental and rebellious nature of today’s younger generation. Though the house (dubbed the “Trojan Goat” by the team) may look strange to the more traditionally minded, the team hoped that anyone could feel right at home once inside the house.

One of the unconventional but intriguing aspects of their house was the “Smart(W)all 3000.” This large, light-emitting diode wall is art that reflects the home’s environmental conditions. When temperature is high, it’s one color; when the house is cool, it’s another. Another climate control aspect of the house is the south wall. It is almost completely glass, shaded by wooden louvers. These louvers can be opened parallel to the sun’s rays in winter to reflect more light into the living room in colder months.

**Virginia Polytechnic Institute**

This entry is the epitome of multifunctionality. Every aspect of the house has more than one purpose, including the solar-electric panels. To celebrate solar energy and not hide it, this team conspicuously mounted the panels on angled racks atop the roof. The panels act as a shading device for the house while collecting electrical energy.

Inside the house, the furniture, rooms, and even the appliances serve more than one purpose. The appliances are grouped together on the north wall and serve as a thermal buffer for the rest of the house. The outer walls of the house were made of a translucent aerogel material that insulated while providing daylighting.



Zeke Yewdall, University of Colorado

**The Solar Village**

Though these fourteen teams were competing against each other, by the end of the week, they had realized that their competitors were also their new neighbors in a little community. All of them had the same ultimate goal of advancing the public perception of solar energy. By the end of the competition, team lines had blurred, and people were hanging out in each other’s houses, cheering each other on for various competitions, and hitting the local restaurant or party scene together every night.

When it came time to pack up and leave, it was rather sad to disassemble the new little village when everyone was just getting to know each another. Interestingly enough, after two weeks, some team members knew their neighbors on the mall better than people they had lived next door to for years back at home. A future article will cover themes found in many designs, how the competition played out, and what is next. The next Solar Decathlon will be held in 2005. The deadline for college proposals is April 30, 2003. See Access for info.

**Solar Decathlon Systems Information**

<i>Item</i>	<i>Auburn Univ.</i>	<i>Carnegie Mellon Univ.</i>	<i>Univ. of CO at Boulder</i>	<i>Crowder College</i>	<i>Univ. of Delaware</i>	<i>Univ. of Maryland</i>	<i>Univ. of Puerto Rico</i>
PV KW (STC rating)	5.76	7.14	7.68	3.35	4.80	5.76	4.16
PV modules	36 BP Solar BP-3160	42 BP Solar BP-5170	63 Astropower AP-120	78 BP Solar MST-43	40 Astropower AP-120	96 BP Solar MSX-60	26 BP Solar BP-160
Charge controllers	5 Solar Boost 3048	4 Trace C40	Outback MX-60, Solar Boost 3048, Trace C40	4 Solar Boost 3048	4 Trace C40	4 Solar Boost 50	2 Trace C40
Inverters	2 Trace SW5548	2 Trace SW5548	2 Trace SW5548	2 Trace SW4048	SW5548 Power Panel	2 Trace SW4048	2 Trace SW5548
Battery bank	800 AH, 48 V	810 AH, 48 V	1,400 AH, 48 V	800 AH, 48 V	1,086 AH, 48 V	800 AH, 48 V	1,800 AH, 48 V
Battery type	Concorde PVX-12100 sealed AGM	16 sealed AGM	32 Deka L-16 flooded lead-acid	24 Eagle Picher AGM	20 Concorde PVX-2580 sealed AGM	38 Concorde aircraft sealed AGM	36 Clean Moura CM-200
Water heating	2 Heliodyne Gobi 4 x 8 ft. flat plate collectors, 80 gal. tank, AC circulation pump	2 Viessmann Vitosol H-30 evacuated tubes, 3 x 3 m, <sup>2</sup> each	12 Sun Utility evacuated tubes, 80 gal. storage, AC circulator pump	Thermal collectors integrated with 12 of the Millenia PV modules, 250 gal. Tank	40 Thermomax evacuated tubes, 80 gal. storage tank, AC circulator pump	40 Thermomax evacuated tubes, 120 gal. storage, PV direct pump	1 Solatron evacuated tubes, 120 gal. storage tank
Construction	SIPs, <sup>1</sup> floors = R-24, outer walls, ceilings, & roof = R-38	SIPs, walls = R-33, roof = R-50	Polystyrene SIPs, walls = R-30, ceiling = R-40, floor with icynene insulation	2 x 6 stud walls with Fg batt, roof = R-40, E2 Andersen windows	Ecothermal SIPs, walls = R-30, ceiling = R-50, floor = R-18	Polyurethane SIPs, walls = R-35, ceiling = R-40	Steel framing 4 in. polystyrene, R-19 & R-21, synthetic wood flooring
Space heating	Trane air source heat pump	Water source heat pump	Carrier air source heat pump with energy recovery ventilator	Radiant floor	Ground source heat pump with radiant floor	Radiant slab	4 evacuated tubes, 300 gal. storage tank
Space cooling	Trane two speed DX split system	Water source heat pump	Carrier air source heat pump with energy recovery ventilator	York 1.5 ton split system	Ground source heat pump	Trane XL 1500 split system, energy recovery ventilator	Hybrid: liquid desiccant / 1 ton carrier with Puron refrigerant
Web site	www.ausolar.org	www.arc.cmu.edu/carnegie_team	solar.colorado.edu	crowder.edu/solar	me.udel.edu/asme/solar	www.enme.umd.edu/solartech	www.habitatupr.edu

<sup>1</sup> Structural insulated panels

<i>Univ. of MO at Rolla &amp; Rolla Tech</i>	<i>Tuskegee Univ.</i>	<i>Texas A &amp; M Univ.</i>	<i>Univ. of TX at Austin</i>	<i>Virginia Tech</i>	<i>Univ. of NC at Charlotte</i>	<i>Univ. of Virginia</i>
5.12	6.08	3.60	3.60	6.00	4.80	5.28
32 BP Solar BP-3160	39 BP Solar (1 for monitoring) BP-3160	12 ASE 300	6 ASE 300 & 25 BP Solar BP-275	80 BP Solar BP-275	16 ASE 300	16 ASE 330
4 Solar Boost 3048	2 Trace C40	2 Trace C40	Connect Power Center PSC500	4 Solar Boost 3048	2 Trace C60	4 Trace C60
2 Trace SW5548	2 Trace SW4048	2 Trace SW5548	Trace SW5548	2 Trace SW4048	Trace SW4024	2 Trace SW4024
1,500 AH, 48 V	3,050 AH, 48 V	1,156 AH, 48 V	1,975 AH, 48 V	1,275 AH, 48 V	800 AH, 24 V	2,000 AH, 24 V
32 Trojan L-16H flooded lead-acid	40 Concorde PVX-2580L sealed AGM	Rolls flooded lead-acid	20 Trojan L-16H flooded lead-acid	20 Concorde PVX-6225 sealed AGM	16 MK BA4D sealed AGM	16 Concorde PVX-2120 sealed AGM
20 Thermomax evacuated tubes, 40 gal. storage tank	4 x 10 ft. Solar Direct flat plate collector 80 gal. storage tank	Progressive tube thermal system	30 Thermomax evacuated tubes	140 sq. ft. of SunEarth absorber plates in custom built vertical collectors	3 x 6 ft. flat plate collector, 1.5 ton water source heat pump, 140 gal. storage tank	5 AET & 1 reclaimed flat plate collectors, 90 gal. storage, heat pump backup
Steel studs, 3 in. XPS foam insulation, walls & floor = R-21, ceiling = R-40	Wood stud walls, batt insulation	SIPs, walls = R-30 floor & roof = R-55	Steel prefab frame, SIP infill, built around Airstream trailer	South, east & west walls = R-15, north wall = R-23, roof = R-31	SIPs, walls = R-19 roof = R-40	Engineered studs, foam insulation, walls = R-50, roof = R-70, ground- coupled floor
Thermomax forced air heating unit	High efficiency heat pump	Water source heat pump	BIO-Radiant Hydro-Air, with domestic hot water	Ground source heat pump & solar thermal	Passive solar	Passive solar with auto- control, ground source heat pump, radiant floor
Mitsubishi variable speed heat pump	High efficiency heat pump	Water source heat pump	BIO-Radiant Hydro-Air ice battery	Ground source heat pump	Water source heat pump passive ventilation	ground source heat pump, hydronic via natural convecting valance
<a href="http://www.umar.edu/~sunhome">www.umar.edu /~sunhome</a>	<a href="http://tusolar.tusku.edu">tusolar.tusku .edu</a>	<a href="http://archnt2.tamu.edu/solardecathlon">archnt2.tamu .edu /solardecathlon</a>	<a href="http://www.ar.utexas.edu/cadlab/decathlon">www.ar.utexas .edu/cadlab /decathlon</a>	<a href="http://www.caus.vt.edu/vtsolar">www.caus.vt .edu/vtsolar</a>	<a href="http://www.uncc.edu/lighting">www.uncc.edu /lighting</a>	<a href="http://solarhome.lib.virginia.edu">solarhome.lib. virginia.edu</a>

**Access**

Zeke Yewdall is a graduate student in solar engineering at the University of Colorado, Boulder, 838 19th St., Boulder, CO 80302 • 303-443-0090  
yewdall@colorado.edu

Catherine Buxton is an undergraduate mechanical engineering student at the University of Maryland, College Park, 4230 Knox Rd. #1313, College Park, MD 20740 • 301-233-8213 • cjbxton@wam.umd.edu

Solar Decathlon, Richard King, U.S. Department of Energy, 1000 Independence Ave., SW, Washington, DC 20585 • 202-586-1693 • Fax: 202-586-8148  
richard.king@ee.doe.gov • www.solardecathlon.org

National Renewable Energy Laboratory, 1617 Cole Blvd., Golden, CO 80401 • 303-384-6516  
Fax: 303-384-6490 • cecile\_warner@nrel.gov  
www.eren.doe.gov/solar\_decathlon

The Home Depot, 2455 Paces Ferry Road, Atlanta, GA 30339 • 800-430-3376 or 770-433-8211  
www.homedepot.com

The American Institute of Architects (AIA), 1735 New York Ave., NW, Washington, DC 20006 • 800-242-3837  
Fax: 202-626-7547 • infocentral@aia.org • www.aia.org

Warmboard, Inc., 8035 Ste. 41-A, Aptos, CA 95003  
877-338-5493 or 831-685-9276 • Fax: 831-685-9278  
info@warmboard.com • www.warmboard.com

Kalwall Corp., PO Box 237, Manchester, NH 03105 • 800-258-9777 or 603-627-3861  
www.kalwall.com

Skywall Translucent Systems, a division of Butler Manuf., PO Box 629, Terrell, TX 75160 • 800-259-7941 or 972-551-6470 • Fax: 972-551-6421  
rcoskery@vistawall.com • www.vistawall.com  
Aerogel building materials

See "A Race Worth Running" in *HP89*, page 8



**sunelec.com**  
The lowest prices for those who do it themselves.



**Looking for more capacity?**

S-530  
530 AH (100 hour rate)  
12 1/4 (L) X 7 1/8 (W) X 16 3/4 (H)  
124 lbs (wet), 96 lbs (dry)

## Now Shipping... THE NEW S-530

- 530 AH (100 hour rate),  
400 AH (20 hour rate)
- Same physical dimensions  
as our S-460
- 1,300 plus cycles at 50% DOD
- Available wet or dry charged
- 7 year warranty



Surrette Battery Company, Ltd.

**800-681-9914**  
sales@rollsbattery.com

**Roll's**  
Battery Engineering



# Thinking Solar? Think Ever Green.

## PURE MARKET FOCUSED

Solar electricity is all we do.

We are dedicated to providing our customers and distribution partners throughout the world with superior support and service. We are in the business of helping you help the environment and grow your business.

## INNOVATIVE

Our proprietary String Ribbon™ wafer and cell technology is among the newest, fastest-growing crystalline technologies in commercial production today. Our fully-integrated manufacturing line is highly continuous and among the most environmentally friendly in the industry.

## EXPERIENCED

Our solar electric panels serve demanding applications throughout the world and all modules are IEEE, IEC, TUV, CE, and UL certified.

## AMERICAN

We are a public company and have our headquarters and factory here in the U.S.

## BECOME A DEALER

Call or apply online.



**EVERGREEN  
SOLAR®**

**Toll Free 866.357.2221**

**[www.evergreensolar.com](http://www.evergreensolar.com)**

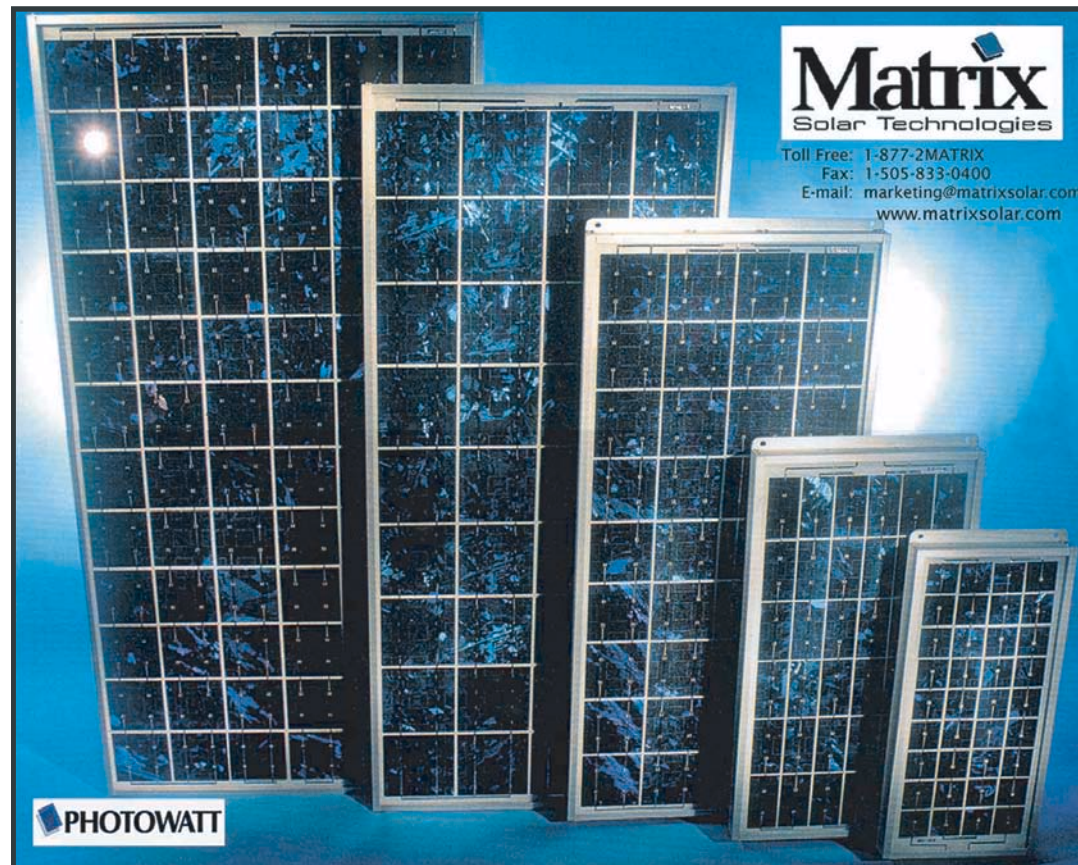

**Matrix**  
Solar Technologies

Toll Free: 1-877-2MATRIX  
Fax: 1-505-833-0400  
E-mail: [marketing@matrixsolar.com](mailto:marketing@matrixsolar.com)  
[www.matrixsolar.com](http://www.matrixsolar.com)

*The best  
modules  
under  
the sun.*

Introducing our  
new modules

**M-PW1650:**  
125, 155, 165  
Watts

**M-PW1250**  
grid-tie:  
115, 125, 135  
Watts

**PHOTOWATT**

# SHARP. Even More Power. Same Space.



**185 Watt 24 VDC**  
Mono-Crystalline  
PV Module

**BEST Single-Crystal  
PERFORMANCE**

- Same footprint as Sharp's 165W poly-crystalline module
- Industry leading 17.0% cell and 14.2% module efficiency
- Texture etched surface and back surface field
- Quick installs with Multi-Contact® connectors and USE-2 cable
- UL® listed with 25 year power output warranty

**Poly-Crystalline PV Modules**

**BEST Multi-Crystal  
VALUE**

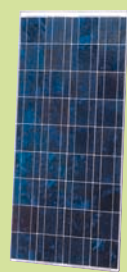

80W 12 VDC

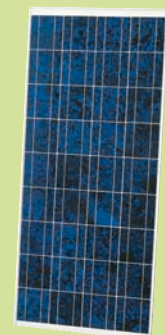

123W 12 VDC



165W 24 VDC

- More efficient than most single-crystal modules
- Textured cell surface delivers more amp hours each day
- Quick installs w/Multi-Contact® connectors and USE-2 cable
- Rugged frame that's easy to mount
- UL® listed with 25 year power output warranty



**Call us for info and a dealer near you.**

**Dealer inquires welcome.**

543 Northeast "E" St • Grants Pass, OR 97526 • **800 GO SOLAR** (800 467 6527) • [energyoutfitters.com](http://energyoutfitters.com)



# You can't always rely on the grid

# Rolls

BATTERY ENGINEERING

1-800-681-9914

Rolls Battery Engineering Ltd.

PO Box 671, Salem, MA 01970 Email: sales@rollsbattery.com www.rollsbattery.com

You have invested in an **alternative energy generating system**. Make sure your **battery is NOT your weakest link!** Insist on North America's **best deep-cycle battery... Rolls**

- ✓ **Dual-container construction** - eliminates leaks, stray current, and decreases maintenance
- ✓ **Unsurpassed cycling** - the most dense active material in the industry - 3300 cycles (50% DOD)
- ✓ **Modular construction** - easier installation
- ✓ **Average life expectancy is 15 years** - warranted for 10 years



# OutBack Power Systems

For more information ask your dealer / distributor or visit us on the web at [www.outbackpower.com](http://www.outbackpower.com)

## Now Stackable up to 16 kW

Dooba says:

**"THIS SYSTEM  
ROCKS!"**

John Rodgers (aka Dooba), OutBack's Lead Engineering Technician, has sent more inverter engineers back to the drawing board during the last ten years than anyone alive!

The long awaited FX2024 is here! Stack up to eight inverter/chargers in series, parallel or both with only 18W of idle for the first inverter and 3W for each additional 2kW inverter.

Pictured is OutBack's new integration hardware. A cool new platform for stacking two FX2000 inverters/chargers, one MX60 MPPT Charge Controller, a MATE System Controller, a HUB Communication Manager and AC and DC Disconnect Enclosures.

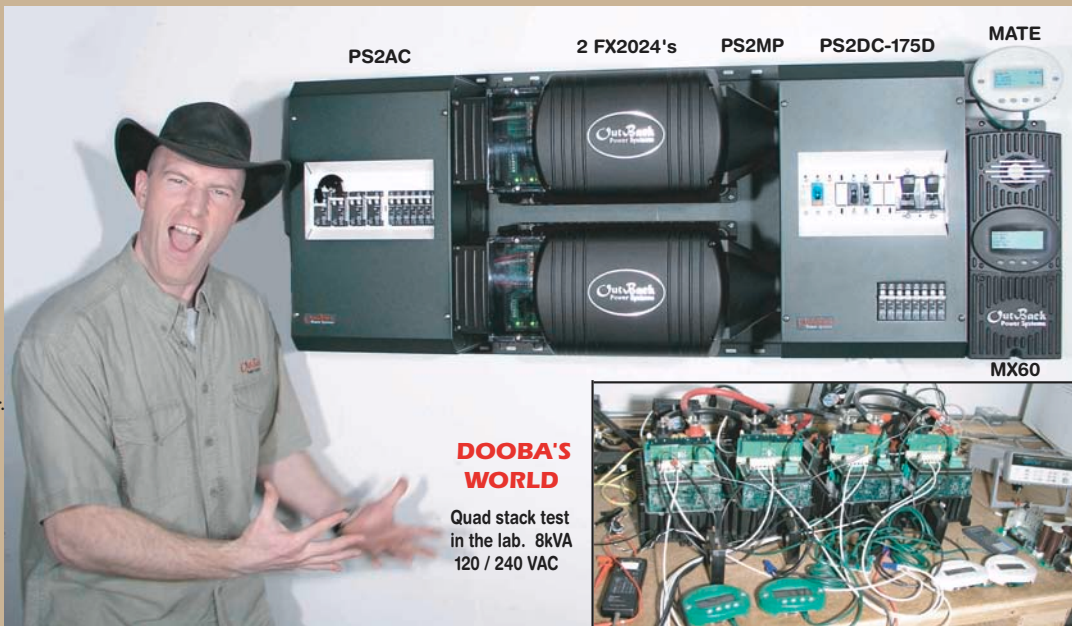

**DOOBA'S  
WORLD**

Quad stack test  
in the lab. 8kVA  
120 / 240 VAC

OutBack Power Systems, Inc.

19009 62nd Ave NE Arlington, WA

TEL 360-435-6030 -- FAX 360-435-6019

# HOME POWER on CD-ROM

## Original Magazine Layouts & More

Color • Indexed • Searchable • Exportable • Printable

Adobe Acrobat PDF® format (reader included)

### Issues #83 (June '01) through #88 (May '02)

Over 5,000 pages of renewable energy information: spreadsheets for load analysis, wire sizing, and the Energy Master for system design; classic basic articles from the *HP* archives; 30 years of solar insolation data & wind data for 900 sites in the U.S.; manuals and spec sheets of popular RE equipment; the *current* InBiz database; and a searchable index. Bonus video clips in QuickTime video format

*SunWorld*, the official magazine of the International Solar Energy Society says, "Together these CDs offer the largest collection of useful and practical information on achieving energy independence ever available."



# \$29

Shipping: \$2 in US  
(Canada \$3; International \$4)

## Special Deal: All seven CDs for \$150

(Shipping: \$8 USA, \$9 Canada, \$12 International)

### Solar6: two CD set, same price

#### Issues #77 (June '00) through #82 (May '01)

Over 6,000 pages of renewable energy information: spreadsheets, and the Energy Master for system design; classic basic articles from the *HP* archives; solar insolation & wind data; manuals and spec sheets; energy related government publications; the In Biz database; and a searchable index.

#### Energy Pathways video CD

The basics of renewable energy, and energy use. All in 37 minutes of digital QuickTime video format.

### Solar5: Issues #71 (June '99) through #76 (May '00)

Over 1,400 pages of *Home Power*; guerrilla solar video clip; 5 hours of audio lecture (MREF '99) on batteries, inverters, ram pumps, RE system Q&A, and solar cooking; spreadsheets for load analysis, wire sizing, and system design; 30 years of solar insolation data; and the In Biz database.

### Solar4: Issues #61 (Oct. '97) through #70 (May '99)

Over 1,200 pages of *Home Power*; 3 hours of audio lecture (MREF '98) on batteries, inverters, and RE system Q&A; video clips from the "RE with the Experts" series; spreadsheets for load analysis, wire sizing, and system design; and the In Biz database.

### Solar3: Issues #43 (Oct. '94) through #60 (Sept. '97)

Over 2,000 pages of *Home Power*; 2 hours of audio lecture on batteries and inverters (MREF '97), spreadsheets for load analysis, wire sizing, and system design; an interactive tour of *Home Power* (Funky Mountain Institute); and the In Biz database.

### Solar2: Issues #1 (Nov. '87) through #42 (Sept. '94)

Contains the original magazine layouts (text & graphics), over 3,900 pages of *Home Power*.

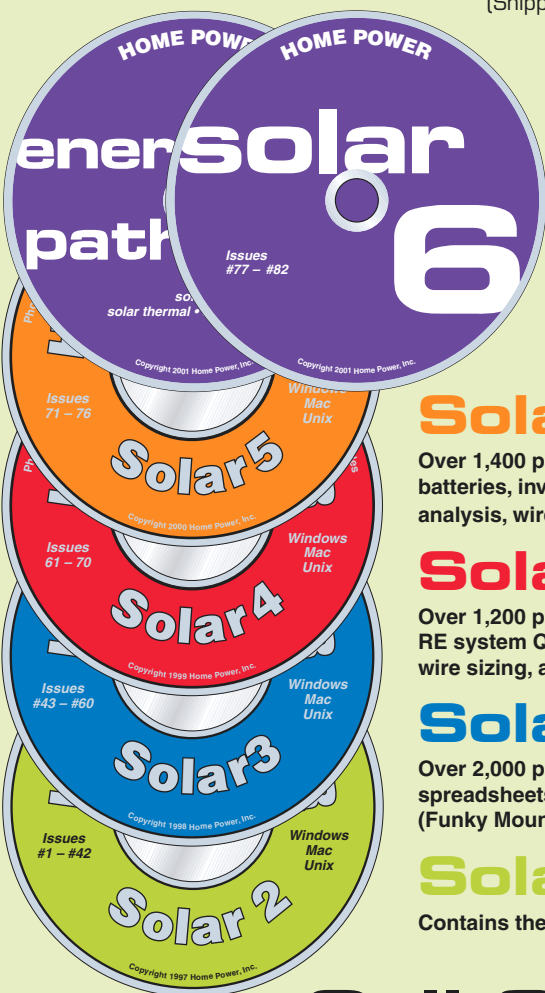

# Call 800-707-6585

Home Power, PO Box 520, Ashland, OR 97520

541-512-0201 • fax 541-512-0343 • [www.homepower.com](http://www.homepower.com)



# What the Heck?

3

## Differential Control

**Used In:** Solar hot water and heating systems

**AKA:** Differential controller, controller, differential thermostat

**What It Is:** A thermostat that measures two temperatures at once

**What It Ain't:** Arbitrary parental supervision



**A differential thermostat is used in solar heating systems to turn pumps or blowers on and off depending on the difference in temperature between the collectors, and the water storage tanks or the the room you're heating.**

A differential thermostat is used to measure the difference in temperature between two locations, hence the word differential. A normal room thermostat measures the temperature at a single location, usually right at the thermostat. Differential thermostats have two sensors that the control constantly monitors, and will turn equipment on and off based on the temperature changes at the two locations.

When the controller senses that one sensor is warmer than the other, it will energize a relay (switch) that can turn on a pump, blower, electric valve, electrical damper, or any other electrical device. When there is no longer a difference in temperature, or it is very small, the differential thermostat de-energizes the pump or other device (turns it off).

In a solar hot water system, one sensor (hot or collector) is placed on the piping very close to the outlet of the solar collector, and the other sensor (cold or storage) near the bottom of the storage tank. When the sun comes up, the collector will become hot very fast. The sensor will then change its resistance and activate the relay in the controller to turn on a pump. When the sun goes down, or dark clouds appear, or the storage tank becomes hot enough, there will no longer be a large "differential" between the two sensors. Then the thermostat will shut the pump off.

A differential thermostat is a fancy ohm meter. It reads two resistances at once, and using factory pre-sets or user settings, it makes a decision whether to turn something on or off, based on the difference between the two resistances.

Chuck Marken, AAA Solar Supply Inc. • info@aaasolar.com

## ENERGY EFFICIENT DC LIGHTING

*Montana Light*

12 & 24 volt DC lighting in a variety of colors, wattages and styles including full spectrum.

Call for nearest dealer or free catalog.

We also have LED lighting

**MADE IN MONTANA U.S.A.**



Product of  
**Light It Technologies**  
P.O. Box 1292  
Dillon, MT 59725  
406-683-2697



## Solar Wind Works

CA Contractor's License: #796322

Renewable Energy Power Systems

- Sales—PV, Wind, & Microhydro
- Design—Off-Grid or On-Grid
- Full On-Site Installation

Chris Worcester

Toll Free! 1-877-682-4503

530-582-4503 • fax: 530-582-4603

PO Box 2511, Truckee, CA 96160

[www.solarwindworks.com](http://www.solarwindworks.com)

off the grid since 1977!



Proven Energy Solutions for Self-Reliance or Utility Buy-Back

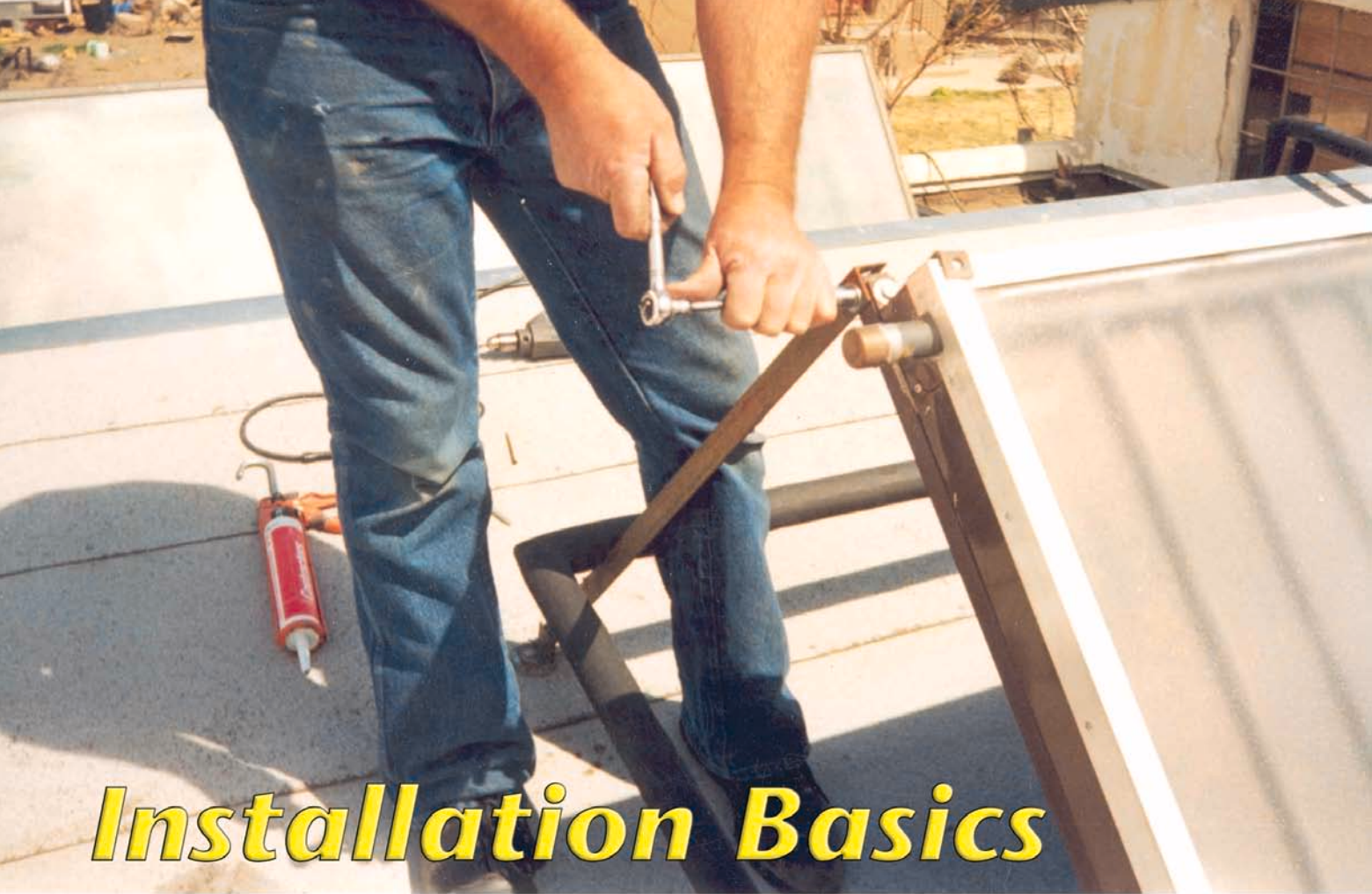

# Installation Basics

## for Solar Domestic Water Heating Systems

**Chuck Marken & Ken Olson**

©2003 Chuck Marken & Ken Olson

**P**lanning to install a solar domestic hot water (SDHW) system? You'll need some basic plumbing, electrical, mechanical, and carpentry skills. Theories and concepts are good background for any work, but putting a wrench, saw, torch, or other tool on the parts is what gets the job accomplished.

This is part of a series of articles on the installation of solar water heaters. This article covers topics that are applicable to most solar heating installations—collector orientation and mounting, plumbing, and controls. What parts go where, how they are installed and integrated, and complete “nuts and bolts” procedures are the topics for this issue.

Other articles in the series will address the specifics of installation, troubleshooting, repair, and maintenance of

both closed loop antifreeze and drainback systems. Articles in *HP85* and *HP86* left off with the component descriptions and functions, and that's where we will begin.

### **Collector Tilt, Orientation, & Access**

We recommend that solar collectors used for year-round domestic hot water face true south and be tilted up from the horizontal at an angle equal to the latitude of the site plus 15 degrees. For example, for Denver, Colorado, 40 degrees latitude plus 15 degrees equals 55 degrees from horizontal. A south-facing surface tilted at an angle equal to latitude will actually collect maximum sunlight year-round. Where aesthetics are a factor, many people choose to mount collectors at the roof angle.

Variations 20 degrees either way will not seriously affect the total annual output (about 5%), but will create some seasonal imbalances. Tilting your collectors up to latitude plus 15 degrees will give you fewer overheating problems in the summer and more hot water in the winter. You should keep in mind that SDHW systems

tend to overproduce in the summer, and any tilt angle less than the recommended optimum will produce even more in the summer. The loss with a lower tilt angle will be in the winter months when the systems tend to produce the least.

Ideally, your collector orientation should be exactly true south if you have an unobstructed solar window. Fortunately, solar hot water systems are surprisingly forgiving as far as orientation. Orientations 15 degrees off true south still capture 90 percent of total daily sunshine. Orientations up to 30 degrees off true south are acceptable, but may lose as much as 20 percent of optimum sunshine. You can increase your collector size to compensate for a less than ideal orientation.

If you have a choice of facing the collectors more easterly or westerly because the home's orientation prevents a due south installation, choose the west for slightly increased performance. The afternoon has higher ambient temperatures. Prevailing cloudiness that exists in some locations may also have a bearing on the orientation of your collectors. Locations with morning clouds will have better performance if collectors are faced in a more westerly direction, and easterly works better for prevailing afternoon clouds.

Your compass lies. It points to magnetic south. In some parts of the U.S., true south can be as much as 22 degrees east or west of magnetic south. To find true south, you need to adjust for the magnetic declination of your site. In Denver, Colorado, the magnetic declination is 14 degrees east. This means that true south is really 14 degrees east of magnetic south or a compass reading of 166 degrees. Refer to the accompanying map for magnetic declination for the U.S. See Access for additional info on magnetic declination.

### Magnetic Declination

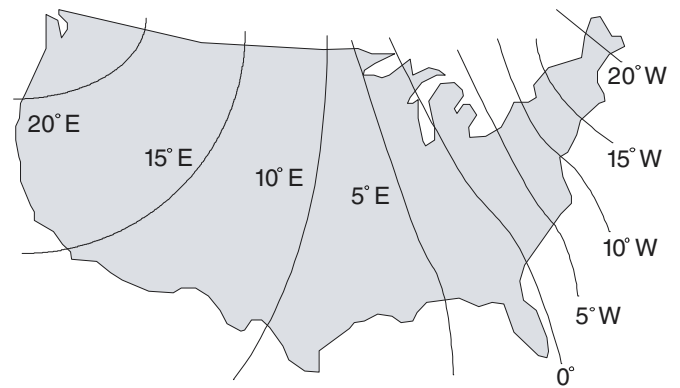

Solar collectors don't work well in the shade. Collectors should be totally unshaded from 9 AM to 3 PM standard time, year-round. Avoid shading earlier and later in the day if you can. Many professional installers use a Solar Pathfinder when they need to evaluate shading. (See *HP16*, and the video clip on Solar1 CD.) One glance into the Pathfinder and you can see all the shading your collectors will get all day and all year. A sun path chart can also be used—see Access for info.

### Mounting Solar Collectors

Solar collectors used for heating domestic hot water (DHW) are usually mounted on roofs, where there is often plenty of unused space. Shading from trees and buildings is usually less of a problem on roofs. Mounting hardware can be supplied by the collector manufacturer or you can build it yourself.

Factory mounting hardware typically comes in two types—flush or rack mounted. Flush mounts (also called stand-off mounts) are used to mount the collectors at the



Flush-mounted system.



Homemade ground-mount rack.



Ground-mounted commercial system.



**Rack-mounted, PV powered system.**

same pitch as the roof. A rack mount has precut or adjustable legs to tilt the collector at an angle to the roof.

Manufactured collectors often have a proprietary extruded aluminum frame incorporating a ready-made channel or other feature to attach the mounting structure with a screw, bolt, or proprietary fastener supplied by the manufacturer. If the mounts are connected to the collector with heavy, self-tapping screws, care should be taken that the screws don't penetrate any farther than necessary, to avoid contact with collector piping or glass.

## Roof Mounting Details

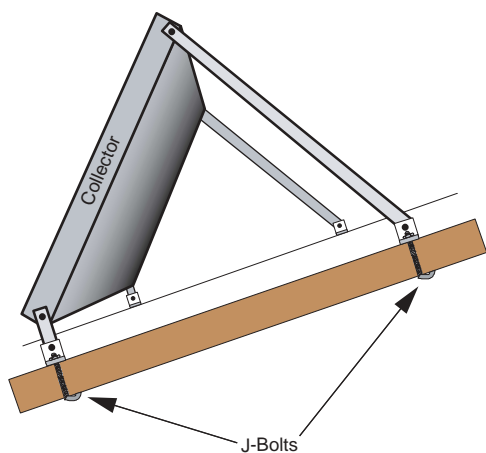

A J-bolt can be made with all-thread rod and wrapped around the roof's structural members.

Whether the rack is homemade or manufactured, painted angle iron can be used for mounts in areas of low humidity. Aluminum angle is preferred where steel and iron are subject to heavy rust over long periods of time. Stainless steel mounting hardware is often used in humid, rainy, or coastal climates. Be sure to choose sturdy enough sizes to support the weight, and in some communities, engineering will be required.

Many homeowner installations use treated lumber. This can provide an adequate collector mount system, but maintenance of the wood is a drawback. Although the treated wood may last for up to a few decades, screwed connections are prone to weaken over time. Through-bolts should be used for all connections to treated wood.

An important consideration to keep in mind regarding all types of roof mounting is that the mount hardware must be fastened directly to the structural members of the roof—the joists, rafters, or trusses. Screwing the collectors to the roof sheathing will not last in a heavy wind or over time. Some local codes require that collectors be J-bolted to the structural members. A J-bolt

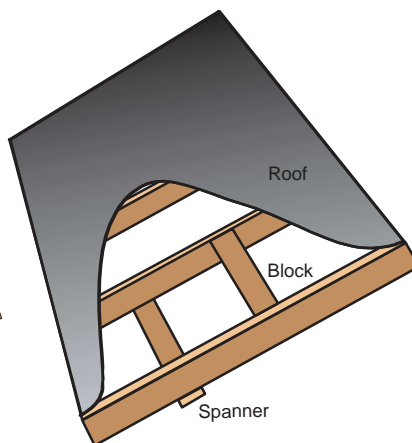

Spanners (2 x 4 or 6 lumber or steel angle) go under the roof joists and are bolted through the roof to the collector mounts. Blocking is lumber that is nailed between the joists against the bottom of the roof, and lag screws are used to secure the collector mounts to them.

wraps around the structural member and is then bolted to the mount. This requirement is not the norm, but is based on concern about lag screws weakening the structural members.

Another method of securing the mounts is with a spanner block placed under or between two structural members in the attic. Long bolts or all-thread are run through the roof and bolted to the mounts. This works well when you have access under the roof.

Lag screws, if used, should be at least 1/4 inch (6 mm) diameter. Minimum length is 3 to 4 inches (7–10 cm) for a normal composition shingle roof with 1/2 to 3/4 inch (13–19 mm) decking. At least 2 inches (5 cm) penetration into the joist or truss is required. Wood shake roofs will require 4 or 5 inch (10 or 13 cm) lag screws. Care must be taken to make sure the lag screws are placed in the center of the structural members. It is often difficult to locate the exact center of 1 1/2 inch rafters.

Cement and clay tile roofs will need to be cut and flashed, and the mounts will be right above the roofing felt under the tiles. The exact attachment details can be rather involved for each type of roof, and are not within the scope of this article.

## Roof Penetrations

Roof penetrations will normally need to be made for collector piping and collector mounts. The wires needed for the collector sensor can be run alongside one or both of the insulated pipes to the collectors. Roof penetrations for piping need to be slightly larger than the diameter of the piping and its insulation. A 2 inch (5 cm) diameter hole is usually all that is required for a single pipe. A 3 to 4 inch (7–10 cm) hole may be required for two pipes.

Using one penetration for each pipe is neater, easier to seal, and exposes less piping to the elements. You

### Roof Jack and Roof Mount Lag Screw Detail

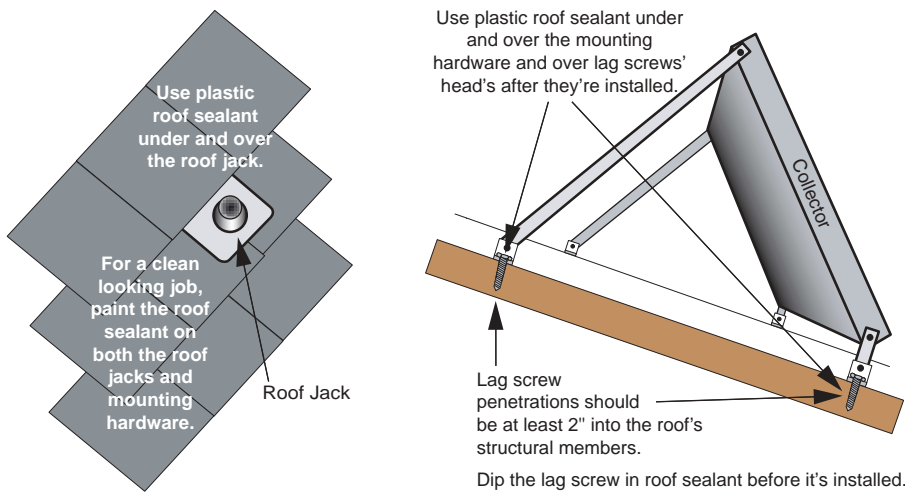

should avoid contact between the pipe and roof structure, since this can cause damage to the pipes over time. Plastic pipe insulators are handy devices for running a pipe through any roof sheathing or structural member. They hold the pipe to avoid movement, which may cause wear and tear, or stress the weatherproof seal.

A roof jack is required for all pipe penetrations. A roof jack is a formed, sheet metal component with a flat bottom and an attached metal or rubber cone-shaped projection that has an opening for pipe, duct, or conduit. The flat portion can be slid under shingles and nailed or screwed to the roof. The cone projection prevents rain and snow from entering the attic or roof space.

The hole in the roof should be placed so that the flat part of the roof jack will slide under an existing shingle above, and over the existing shingles below. Coat the top of the fastener with a generous dollop of roof sealant. If you are penetrating a metal roof, you should use the roof jacks provided by the manufacturer of the roofing material.

Sealing the mount screws or bolts and the part of the mounts that are directly in contact with the roof surface can be done with roof sealant. Contractor's silicone caulking is good for metal or other nonporous surfaces. All of these products, and roof jacks of various sizes and types are available at home centers and plumbing supply houses.

### Ground Installation

Pipe distance to and from the collector is often an issue with ground installations. Lengths of up to 50 feet (15 m) are generally acceptable if the piping is well insulated. If the piping is underground, it and its insulation should be encased in a larger PVC pipe.

The classic ground installation uses a very simple "pier" of concrete to secure the collectors to the ground. You can make the piers by digging holes with a post-hole digger and pouring ready-mix concrete. Small installations of one to three collectors will require four piers, which must extend below the ground frost level for your area.

When the concrete is poured, you should embed an anchor bolt or a 6 to 12 inch (15–30 cm) piece of angle iron or aluminum angle. This is used to fasten the collector mounts after the concrete has had time to cure. A string or torpedo level should be used to level the tops of all piers and

anchor bolts for easier installation and a professional appearance.

### Wall Mount Installation

Factory or site-built mounts can be easily adapted for mounting collectors to the side of a home or other building. This is an often forgotten option that can work very well if the home is oriented with a suitable unshaded southern wall. Sealing the roof is no longer a concern, and the extra work of a ground mount is eliminated.

On many two-story homes, there is enough space on the second story wall to install a collector or two without conflict with any windows. If this is an option for you, it is probably the easiest installation from the standpoint of work location and collector mounting. The mounts should be lag screwed or bolted directly to the center of the wall studs rather than just the wall sheathing. Be sure to use a sturdy enough fastening technique to handle the shear weight of the collector and water.

### Collector Piping

Copper is the favored material for collector piping. SDHW systems can get very hot at certain times of the

### Concrete Pier

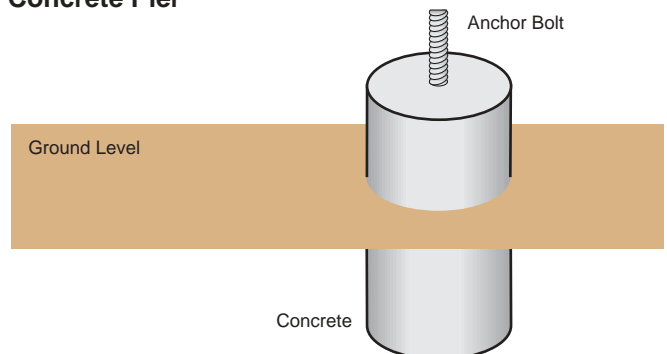

## Reverse Return SDHW Piping

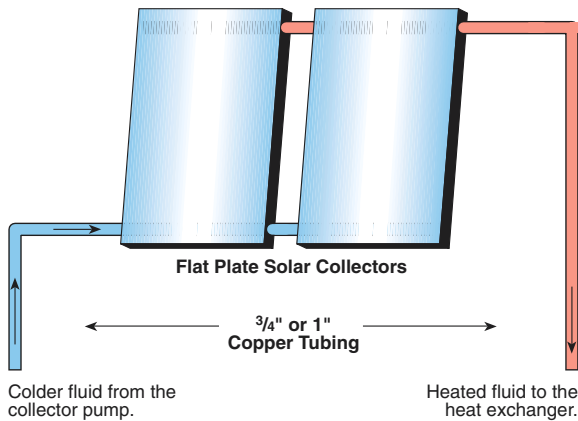

High temperature black insulation should be used on collector piping; gray insulation is OK for standard piping.

year, and copper will take all the heat a system can produce. Chlorinated polyvinyl chloride (CPVC) piping is sometimes used for passive water heaters. Closed loop systems can exceed the temperature and pressure limitations of CPVC. Other types of plastic piping with high temperature limits in the 200°F (93°C) range are also unsuitable for closed loop systems. The exceptions are silicone tubing and Teflon tubing. However, both of these have special connections and components that you won't find at home centers.

The collector supply pipe is always connected from the pump to the cold inlet at one end of the bottom header pipe of the collector. The return pipe runs from the hot outlet of the collector(s) and runs to the heat exchanger next to the storage tank. The hot collector outlet is always at the end of the top header that is diagonally opposite and farthest away from the cold inlet at the end of the bottom header. This piping arrangement is called "reverse return," and will give an even flow through the collector(s).

Hard copper pipe is available in lengths up to 20 feet (6 m) and can be cut with an inexpensive pipe cutter. Type M copper with a red stripe along the length is all that is normally required for residential plumbing. Pipe size is typically 3/4 inch for smaller systems and 1 inch for larger systems. Type L soft copper is rarely used, but may be handy if a flexible pipe is needed to make up for poor alignment of pipes.

### Exposed Pipe Insulation

All pipe insulation exposed to ultraviolet (UV) rays of the sun needs protection for long-term durability. A good UV-resistant paint will last from five to ten years, and manufacturers

of high-temperature, closed-cell insulation have recommended products.

If you want a maintenance-free covering for the insulation that will last a lifetime, flat, architectural-grade aluminum used for camper shells and gutters is a good solution. It is easily bent around the insulation and can be fastened with very short screws (using proper care), or bent to form a self-fastening clip.

### The Control System

Almost all solar water heaters use the same type of electronic control, a differential control (aka differential thermostat), which is described in depth in *HP85*, *HP86*, and in a "What the Heck?" feature in this issue. The differential control is used to control the system if AC pumps are used. The Goldline GL-30 has two temperature sensors. One is located at the outlet (top) of the collector piping. The other is located at the cold DHW piping on the storage tank. This control can be

Some of the tools and parts you might need for soldering copper tubing include solder, flux, Teflon tape, and fittings.





## Soldering Copper Pipe

Many people have trouble soldering copper pipe. Follow these five simple steps and you'll have solid, leak-free solder joints, 100 percent of the time.

Use a propane, MAPP gas (methylacetylene-propadiene), or acetylene torch—the temperatures required don't demand an oxygen/acetylene torch. Solder containing lead, better known as 50/50 (50% lead and 50% tin), is not allowed on potable water connections for health safety. Lead-free solder such as 95/5 (95% tin and 5% antimony) is better for solar loop systems because of its higher melting point.

1. Make sure the pipe will stay dry during the soldering process. Clean the pipe and fittings with a wire brush or emery cloth. The surface must be bright, fresh copper, free of oxidation.
2. Use a good grade of soldering paste flux. Brush it on the entire surface of cleaned pipe and fittings to chemically clean the surfaces.
3. Apply the heat from the torch to the fitting at the full depth of pipe penetration (underside if possible), not to the pipe.
4. Apply the solder to the pipe on the opposite side from where the heat is applied to the fitting. Dab it onto the pipe a few times after heating the fitting. The solder will flow into and around the joint when the joint is hot enough. Quickly remove the flame from the fitting after the solder melts and completely fills the joint(s).
5. Don't touch or jiggle the pipe or fittings while they are cooling.

When a solder joint is cleaned, fluxed, and at the right temperature, you'll see solder flow into the joint and "disappear" if you watch closely. Failed solder joints are always caused by careless cleaning, poor or no flux, an underheated or overheated joint, or movement of the joint(s) while they are cooling.

On small pipe,  $\frac{1}{2}$  to  $\frac{3}{4}$  inch, two or more joints can be heated and soldered at once, such as all three sides of a small tee fitting. The larger the pipe, or the heavier the fitting, the longer it takes to heat the joint to proper temperature. Soldering the headers together on the collectors will normally take a little longer than single joints, since the header pipes can be 1 inch or larger. Outdoor temperature and breezes may also affect the time it takes to solder a joint.

### Step 1

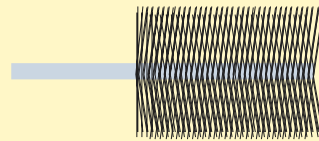
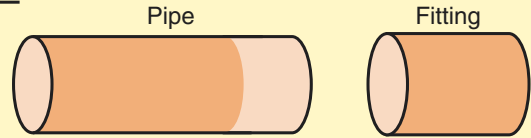

Clean copper pipe and fitting with a wire brush or emery paper until they're both shiny bright.

### Step 2

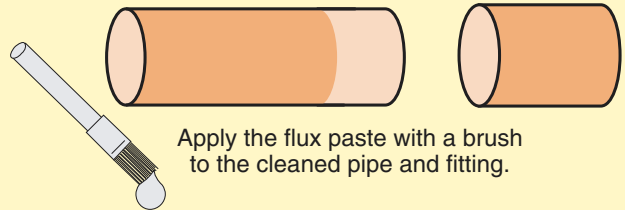

Apply the flux paste with a brush to the cleaned pipe and fitting.

### Step 3

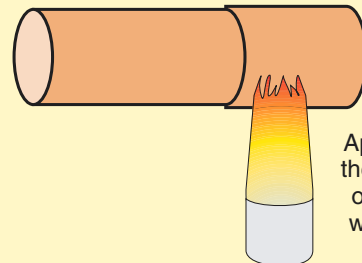

Apply heat to the underside of the fitting with a torch.

### Step 4

Apply solder to the pipe opposite to where the heat is being applied to the fitting.

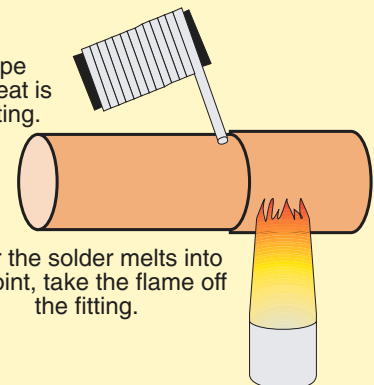

After the solder melts into the joint, take the flame off the fitting.

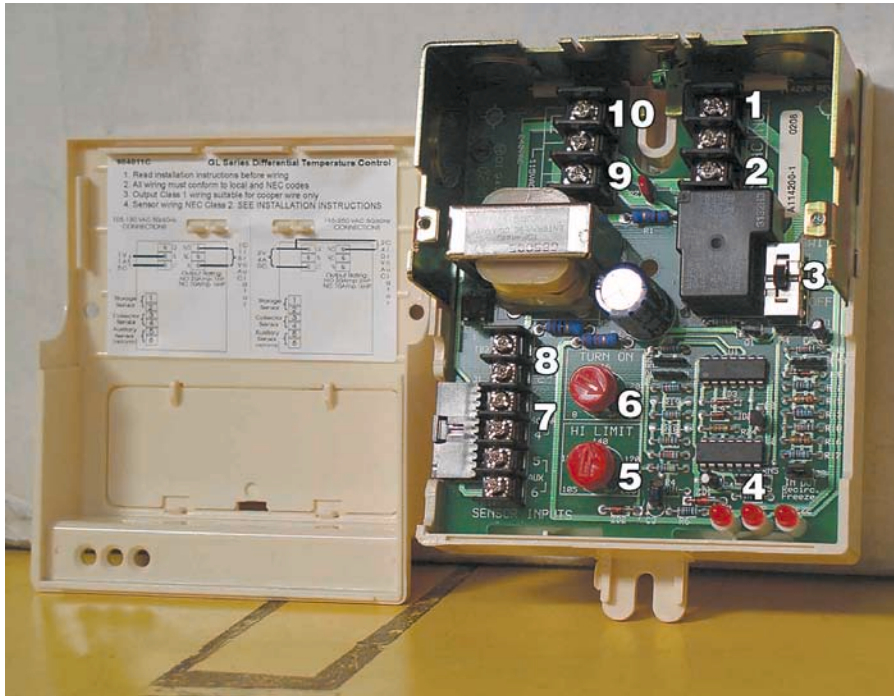

### The Goldline GL-30, Differential Control:

1. Terminal for 120 VAC hot (black) wire to collector pump, and DHW pump if used.
2. Terminal for 120 VAC neutral (white) wire to collector pump, and DHW pump if used.
3. On, off, or auto mode switch.
4. LED lights indicate if control is powered, pumping, and/or recirculating.
5. High limit dial.
6. Differential temperature dial.
7. Terminals for collector sensor wires.
8. Terminals for tank sensor wires.
9. Terminal for 120 VAC hot (black) wire.
10. Terminal for 120 VAC neutral (white) wire.

purchased with an existing cord set and receptacle for the pump(s). An alternative control is a Heliotrope Thermal Delta-T.

Thermostat wire (two-conductor, #20 or #22) is used in the sensor control wiring. It is important that the sensors have a good mechanical and thermally conductive connection to the pipe. This is done with a stainless steel, automotive hose clamp on the flat portion of the sensor. Pipe insulation fits over the sensor to correctly read the temperature of the pipe and the liquid flowing in the pipe. Each control has two sets of two terminals for the sensor wiring (four wires total). You must ensure that you correctly attach each sensor to the correct set of terminals. The wiring has no polarity and either wire of each sensor may be correctly attached to either terminal.

The GL-30 control has two small dials to set the control for the correct turn-on temperature and a high-limit temperature. The Delta-T has field selectable DIP (dual in-line package) switches for the same purpose. A recommended turn-on differential temperature for closed loop systems is about 16°F (9°C) for systems with a heat exchanger integrated tank. The turn-off differential temperature is fixed at 4°F (2°C) for the GL-30 and 4 or 5°F (2–3°C) for the Delta-T depending on the DIP switch setting.

The Delta-T DIP switches offer a choice of an 18:5 differential or a 9:4 differential. The higher choice is for closed loop and drainback systems. The lower differentials are for systems without heat exchangers,

and systems used in nonfreezing climates like Hawaii. The exactness of the differential is not critical, because the optimum temperature can vary slightly depending on many factors. Since all closed loop systems incorporate a double-wall heat exchanger, the turn-on for closed loop systems should be more than 12°F (7°C), and generally less than 20°F (11°C). The high temperature limit on the controls is normally set to turn the system off at 180°F (82°C), as recommended by most tank manufacturers.

Both of these controls have a provision for freeze protection in very mild climates. This is a recirculation function that turns the system on as the collector temperature approaches freezing. Freezing is averted by circulating warm water through the collector. This function should be disabled in closed loop and drainback systems. The controls also have a three-position switch (on, auto, off). The switch needs to be in the auto position for the unit to automatically control the pumps with the sun cycle.

A small LED light on the front of the control will tell if the control is powered, and a second light indicates whether the control is running the pump(s). The GL-30 also has a third light to indicate if the recirculation function is on. This light should never be on in a closed loop system if the recirculation function has been disabled. The GL-30 normally ships with the recirculation disabled, but it is a good idea to check this with either control when installing any system in a climate subject to freezing.

The control is usually placed near the pumps that it controls, and this placement is somewhat dependent on

the exact type of system you are installing. Both controls discussed here come with good instructions detailing all of the above features.

**PV Powered DC Pumps**

It would seem that if there were enough sunlight for a PV module to power a pump, there would be enough sunlight to make hot water. There is *most of the time*. In reality, a PV pump will, at times, turn on before there is sufficient sunlight to make hot water and turn off long after the stored water is already as hot as the collector can produce. This inefficiency due to mismatch between electrical and thermal power can be minimized by using the pump manufacturer's recommended PV module size.

An SDHW, DC pumped system will require a dedicated PV module that is not connected to batteries unless you can find or are capable of building a DC powered differential control. Linear current boosters that add to the efficiency of other PV pumping systems should not be used on dedicated, PV powered SDHW systems. They increase the inefficient mismatching of the thermal energy available to electrical power produced. If you have a whole-house PV system with a large enough inverter, you should consider using less costly AC pumps and a differential control.

The choices of DC hot water circulating pumps are much more limited than AC pumps, and this also could be a consideration. DC pump flow rates and head are dependent on the power output of the PV module(s). AC pumps are much more tolerant of air in the system than DC pumps. A few small bubbles that mean nothing to a higher power AC pump can stop the circulation of some DC pumps.

**Skills to Use**

We hope these skills and the familiarity with the collector mounting options, plumbing, and control wiring have prepared you for the more detailed topics of the installation and repair of different systems. Our next article will cover what is considered the most complex of SDHW systems—the closed loop, antifreeze-type system. After that will be a repair and maintenance article on the same system, followed by the installation of the simpler, drainback solar water heating system.

**Access**

Chuck Marken, AAA Solar Supply Inc., 2021 Zearing NW, Albuquerque, NM 87104 • 800-245-0311 or 505-243-4900 • Fax: 505-243-0885 • info@aaasolar.com www.aaasolar.com

Ken Olson, SoL Energy, PO Box 217, Carbondale, CO 81623 • Phone/Fax: 720-489-3798 • sol@solenergy.org www.solenergy.org

Goldline Controls, Inc., 42 Ladd St., East Greenwich, RI 02818 • 800-294-4225 or 401-884-6990  
 Fax: 401-885-1500 • sales@goldlinecontrols.com  
 www.goldlinecontrols.com • Differential controls

Heliotrope Thermal, 4910 Seaport Ave., Richmond, CA 94804 • 510-237-9614 • Fax: 510-237-7018  
 info@heliotropethermal.com  
 www.heliotropethermal.com • Differential controls

Solar Pathfinder, 3680 Highway 438, Centerville, TN 37033 • Phone/Fax: 931-593-3552 • Cell: 931-242-0658  
 pathfind@mlec.net • www.solarpathfinder.com

To find your local magnetic declination see this Florida State Univ. site:  
 www.gly.fsu.edu/~kish/field/projects/p4/proj4b.htm

To generate a sun chart for your latitude see this University of Oregon site:  
 http://solardata.uoregon.edu/SunChartProgram.html

See also “Solar Hot Water: A Primer” in *HP84*, “Solar Hot Water for Cold Climates—Closed Loop Antifreeze Systems,” in *HP85*, and “Solar Hot Water for Cold Climates—Drainback Systems” in *HP86*.



**Snorkel Wood-Fired Hot Tubs**

**Real WOOD HOT TUB**

HALF THE COST

of Plastic Spas!

LOW-COST WOOD HEAT!

Gas/electric heaters, hydrotherapy jets optional!

10 Models! Made in USA!



Made in USA!

Mail this coupon or CALL TOLL FREE

1-800-962-6208

**YES!** Rush me facts on SNORKEL Wood-Fired Hot Tubs including current SALE!

Name

Address

City/State/Zip

**Snorkel Wood-Fired Hot Tubs**  
 Dept. HP034-A, 4216 6th Ave. South, Seattle, WA 98108  
 www.snorkel.com

FREE SALE CATALOG!



# SUN

www.sunelec.com

# ELECTRONICS

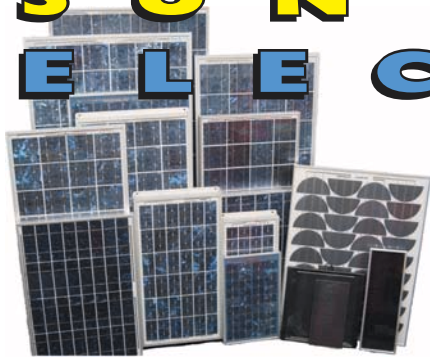

Photovoltaic Modules from \$2.95 / Watt

## Clean, cost effective solutions for power problems since 1973



Wind generators from \$350

### Special Deals on Inverters!

5,500 Watt,	Sine	\$2,550
4,000 Watt,	Sine	\$2,200
3,600 Watt,	Mod-sine	\$1,100
2,400 Watt,	Mod-sine	\$970
1,500 Watt,	Mod-sine	\$680
800 Watt,	Mod-sine	\$240
400 Watt,	Mod-sine	\$80



Deep cycle, 6V, 225 AH batteries from \$45

Inverters from \$.20 / Watt



National & International Dealers Wanted:  
Contact John Kimball

511 N.E. 15th Street, Miami, FL 33132

Tel: (305) 536-9917 • Fax: (305) 371-2353 • www.sunelec.com

## Solar water pumps for every purpose

Don't throw energy down the drain with an inefficient water pump. Dankoff Solar DC pumps use 1/3 to 1/2 the energy of conventional AC pumps run by inverter.

Vertical lift to 960 Ft. (290 m)  
Pressurizing to 100 PSI (7 bar)  
Flows to 75 GPM (285 lpm)

*Flowlight® Booster Pump*  
*SunCentric™ Centrifugal*  
*Solar Force™ Piston*  
*Solar Slowpump™*  
*Solaram™*



# SURFACE PUMPS SUBMERSIBLE PUMPS

*ETAPUMP® and more . . .*

Depths to 650 Ft. (200 m)  
Flows to 50 GPM (200 lpm)



Water supply for homes, villages, agriculture, parks and recreation, and more—since 1983

Also a wholesale distributor of power system components

Call for a dealer referral  
Toll-Free (888) 396-6611  
(505) 473-3800

www.dankoffsolar.com



# ESSENTIAL ELEMENTS



AVAILABLE FROM

TROJAN MASTER DISTRIBUTORS WORLDWIDE  
Phone: 800-423-6569 • [www.trojanbattery.com](http://www.trojanbattery.com)

Your Lifetime Energy Source™



## INTRODUCING THE GX SERIES GRID-TIE INVERTERS

- GRID INTERACTIVE OR STAND ALONE
- MODULAR (3.6KW PER MODULE)
- EXPANDABLE
- REMOTE MONITORING
- OPTIONAL METERING
- CHARGING CAPABLE
- 2U(3.5") HIGH
- 19 OR 23 INCH RACK MOUNTABLE

GX SERIES INVERTER MODULE



# EXELTECH

7317 Jack Newell Blvd North Fort Worth, Texas 76118-7100 voice: 817-595-4969 fax: 817-595-1290  
toll free: 800-886-4683 e-mail: [info@exeltech.com](mailto:info@exeltech.com) website: [www.exeltech.com](http://www.exeltech.com)



# SUNELCO

*Have it your way*

Order your 15th edition Sunelco Planning Guide & Product Catalog today.

Still only \$5

800-338-6844

www.sunelco.com

100 Skeels St.  
PO Box 787  
Hamilton, MT 59840



## HuP Solar-One Batteries



To receive information on our complete line of RE products contact **Northwest Energy Storage** @ 800-718-8816 or 208-267-6409 9 am-4 pm pst 6778 El Paso St., Bonners Ferry, ID. 83805  
www.nwes.com www.hupsolarone.com batteries@nwes.com

- **HuP Solar-One** still has the best warranty in the business!
- **HuP Solar-One** positive plates are wrapped in an envelope!
- **HuP Solar-One** uses a patented recipe to achieve extra life at deeper cycles than the competition!
- **HuP Solar-One** has removable cells for easier installation!
- **HuP Solar-One** offers free shipping in the lower 48 states!
- **HuP Solar-One** uses flip top caps that make maintenance quicker!
- **HuP Solar-One** is available in 8 sizes, reducing paralleling!
- **HuP Solar-One** provides all lead coated solid copper interconnecting hardware, lifting strap, users manual, and a written warranty!
- **HuP Solar-One** has over 9 sq. in. of terminal area for multiple lug connections!
- **HuP Solar-One** batteries have been in RE service for over 10 years!

**hupsolarone.com**  
There Is A Difference!

**Northwest Energy Storage, The Exclusive HuP Solar-One Representative for Renewable Energy**

# Meeting your electrical energy needs



Unbreakable  
Lightweight  
Reliable  
Weather Resistant



UL Approved  
Flexible  
Shadow Tolerant  
Durable

At a time when power is in demand.

**UNI-SOLAR**  
The Power To Change The World

Bekaert ECD Solar Systems, LLC  
3800 Lapeer Road • Auburn Hills, MI 48326  
(800) 843-3892 • Fax: (248) 364-0510  
[www.uni-solar.com](http://www.uni-solar.com)

Another example of  
**ovonics**  
*@work*  
Sustainable Energy Solutions Through Innovation

Solar Electric Inc.  
5555 Santa Fe Street, Suite D  
San Diego, CA 92109  
(800) 842-5678 • Fax: (877) 842-5678  
[www.solarelectricinc.com](http://www.solarelectricinc.com)  
[solar@cts.com](mailto:solar@cts.com)

# Learn Solar Energy

# SoL

 is "Solar-on-Line"  
*Internet-based Distance Courses  
with practical skills workshops*

Internet-based distance courses year-round  
Practical skills workshops offered in the US and Mexico  
Visit the Solar-On-Line website for schedule and details

For current schedule of On-line Courses and Workshops  
Click on SoL [www.solar-on-line.org](http://www.solar-on-line.org)

E-mail: [SoL@SoLEnergy.org](mailto:SoL@SoLEnergy.org) Phone/Fax: 720-489-3798

See Happenings in this issue for the 2003 schedule of courses.

# The Solar Van:

## A Mobile Renewable Energy Station



**Gerald J. Lemay**

©2003 Gerald J. Lemay

The solar van travels for events and education, but parks here to sell solar electricity to the utility.

**W**hile on sabbatical from the University of Massachusetts Dartmouth, I was inspired to actually do something with renewable energy (RE) technology. At a conference for RE educators, I saw an off-grid demonstration system on a flatbed trailer. I decided to build a transportable renewable energy station within a cargo van. But my plan was to implement the “sell” mode of the inverter, and provide electricity to the utility company.

### Preparing the Mobile Platform

I purchased a 1996 Ford Econoline van at a discount from Dave Farland's Shawmut Auto of Acushnet, Massachusetts. I removed the racks and cable TV installer benches. I had additional suspension for the

rear axle installed by Couet Springs of New Bedford, Massachusetts, because of the additional weight of the batteries and the electronics. Each of the eight batteries weighs 126 pounds (57 kg) and the inverter/charger weighs 90 pounds (41 kg).

I then had Yankee Builders build a battery box with a removable front. They also added a partition to separate the power station electronics from the demonstration space that contains various appliances like a microwave oven, a blender, and an electric hot water kettle.

### Installing the Power Control Electronics

After the finish on the battery box and partition was dry, I was ready for the trip to Richard Gottlieb and Carol Levin's Sunnyside Solar of Guilford, Vermont. This was the first time the van had been driven a long distance after the rear suspension additions, and the ride was a bit stiff.

When I arrived, Richard was in town purchasing additional hardware for the project. Carol greeted me at the door, and their assistant, Doug, was already assembling the system components on the bench. Sunnyside Solar is truly a solar project crafter's delight. They have every imaginable tool, and boxes of wire, PV



modules, and system components. Photos of countless RE installation projects line the walls. This is the home of two of the Northeast's greatest renewable energy pioneers. This was the place to be, and it was time to get down to work.

The system includes a Trace SW2512 inverter/charger, a Trace C40 charge controller, and a Trace 250 amp DC disconnect. Eight, 6 V, 350 AH, Surrette S-460 (L-16 equivalent), lead-acid batteries store the energy from the two, AstroPower, 120 W PV modules. A circuit breaker panel provides AC distribution from the inverter's output.

First, the 90 pound inverter/charger had to be prewired before installation into the cramped space in the back of the cargo van. Next, we disassembled the battery box so that the batteries could slide in easily. We used additional screws to reinforce the partition wall boards. The floor of the battery box was fitted with a piece of 1/2 inch (13 mm) plywood. We worked hard until dark on this first day.

By nightfall of the second day, the installation of the power electronics was completed. The batteries, which were charged on delivery, tested well, powering an AC drill via the inverter. We wired one of the two PV modules, and the cable and plug were set up so I could

**With educational materials on the side and a PV within reach, the van attracts a lot of attention.**



**These students from the University of Massachusetts are among the many that use the solar van to learn about renewable energy.**

wire the second module myself later. As I bid farewell to Richard and Carol, I looked forward to the next phase—setting up the AC service.

### Harvesting Sunlight

I was very fortunate to find Stephen Borowicz, an electrician with co-gen installation experience. Stephen also worked with batteries when he was in the Navy on a nuclear submarine. The 100 amp service installation was the first time the solar van's energy was used in an actual application. We powered the 10 amp, ground rod pounding tool with the energy stored in the van's batteries.

A problem occurred in the initial tests of the system. Sending electricity back to the utility caused the ground fault circuit interrupter (GFCI) to trip. The code-required GFCI we used is unidirectional, so we replaced it with an outlet wired to a standard breaker to prevent it from tripping.

At this point in the project, the system was ready to spin the KWH meter backwards. It was time to start harvesting sunlight and converting it to electricity!

Doug from Sunnyside Solar had made a very functional, temporary, ground-level wooden PV mount, but I really needed a top-of-the-van mount. A neighbor designed and built a frame out of PVC for me. I assembled it easily, but it is not very robust. One of the upgrades needed for the project is to install a standard PV mount.

I took amp-hour and voltage data over the next 100 days to see how long it takes to completely recharge the batteries in the van. In round numbers, the battery bank stores 20 KWH of energy. Incidentally, this is approximately how much electrical energy a typical

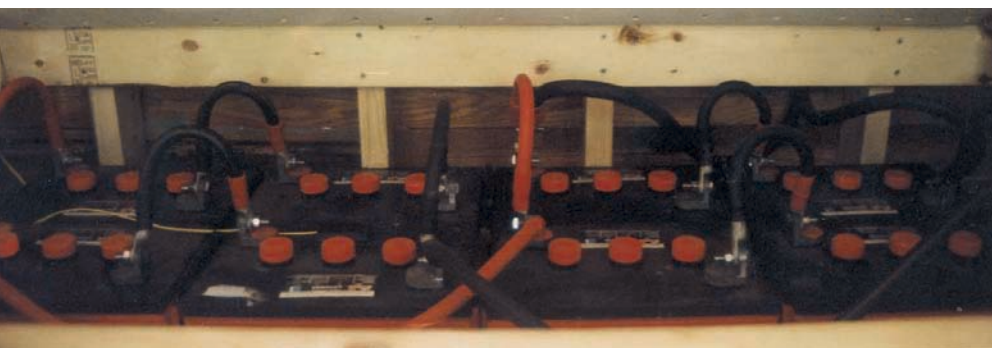

**Eight, Surrrette S-460, lead-acid batteries provide ample energy storage.**

American household uses in one day. It takes 40 days of solar harvesting on site with the van's two panels to generate that much electricity.

### **Recognition as a Generation Company**

Once the system was operational, the real fun began—connecting and complying with the utility. A phone call and visit to Commonwealth Electric of New Bedford, Massachusetts, lead to a phone call from Beatrice Lord, a mid-account executive. She sent paperwork, and I applied for recognition as an off-site power generation station.

On receipt of the completed application, a site visit was conducted by Commonwealth Electric personnel. In addition to Beatrice, other personnel who came for the site visit were a power engineer, another accounts person, and a lady with experience with nontraditional power generation on Nantucket Island. The lady from Nantucket had not seen my type of system before. Apparently, all the systems she knew about were domestic and not intended to produce more electricity than they consumed. I am not living in the van, nor using any electricity other than to power the electronics and float the batteries. My primary purpose is to sell electricity to the utility as a demonstration project.

The engineer was concerned about liability if someone gets hurt because of my system. Beatrice handed me a folder with the contract information. I read and signed it, and the engineer stated that I also needed a stamped line drawing of my system. It all seemed straightforward at that point.

A week or so later, however, I received a “requirements and concerns” document stating what I

had to do to comply with utility regulations before my electricity would be accepted. This is a document related to fossil-fuel-burning generator systems and not photovoltaic systems. There is no mention of the IEEE 929-2000 standard or of the UL 1741 standard, both of which relate to PV installations.

I was fairly inactive during the winter months of 2000 and 2001. I spent this time looking for a PE (licensed

professional engineer) to stamp my drawing. Several people who might stamp the document were either too busy or reluctant to deal with the utility. I started taking the review course that leads to PE licensing (I have since completed the course, passed the fundamentals exam, and passed the PE exam in October 2002). Finally, I found an engineer who did a telephone call walk-through of the system, stamped my drawing, and charged me US\$150.

Commonwealth Electric, renamed NSTAR, then paid me a second visit. They had consulted with a protection engineer in northern Massachusetts, and the feeling was that my system was small and standard. All I needed was an IEEE 929-2000 document signed by an electrician or PE, and the town's electrical inspector had to submit approval of the 100 amp service.

I complied with the utility's request for an IEEE 929 signed document. This cost me another US\$150 from

**In the back: the battery box and power equipment.**



# Solar Van PV System

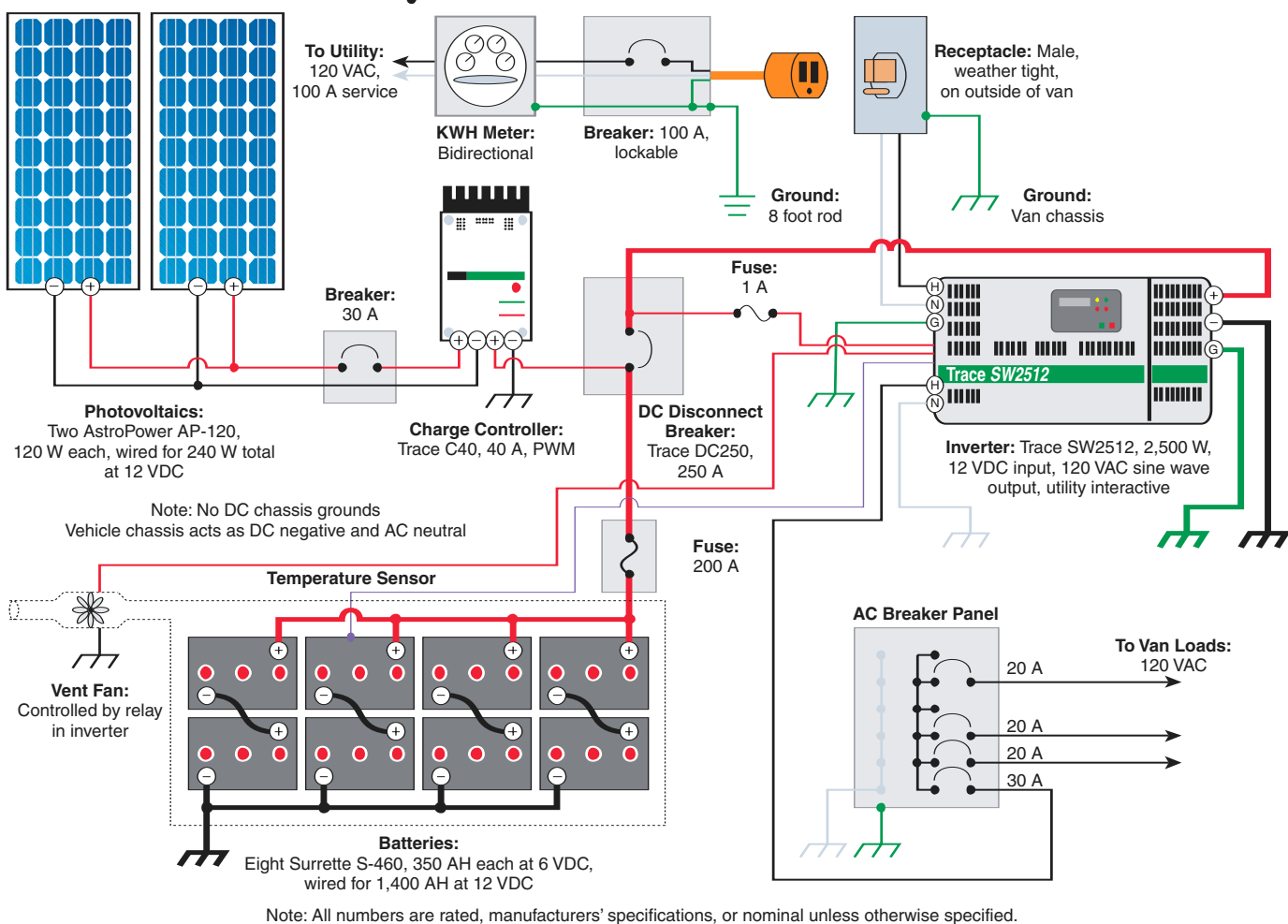

another PE. There were some delays with approval by the electrical inspector. His two issues were with the PE stamp and the GFCI at the 100 amp service.

At first, the electrical inspector wouldn't accept the PE-approved document because it had an old generic stamp on it, instead of the newer version that designates it as an electrical engineer's stamp. Information from the Massachusetts Licensing Board Web site was all I needed to prove the validity of the stamp.

To resolve the issue with the GFCI and to make the system code compliant and safe was a little more work. Our initial installation used an outlet. That meant that the 100-amp service was accessible by anyone who wanted to plug something into it. Also, this was an outdoor installation. The code for this arrangement requires a GFCI, but the GFCI always tripped when electricity was being fed back to the utility. The original remedy was to remove the GFCI and install a conventional circuit breaker. But this solution was not code compliant because it still relied on an outdoor outlet.

So, to continue using a conventional circuit breaker, the electrician (at the suggestion of the electrical inspector) removed the outlet and hardwired my power cord directly to the circuit breaker panel. We were then code compliant, and I could send electricity back to the utility without tripping the breaker.

The connection to the grid was via a 20 amp line cord. One end was hard-wired into the 100 amp service, and the other end was wired to a female cord cap that's plugged into the outside of the van. The male, weatherproof receptacle is mounted on the outside of the van, and was connected with #12 (3 mm<sup>2</sup>) wire to the "AC hot in" and the "neutral in" terminals of the Trace SW2512 inverter. From the "set grid usage" menu under the "inverter" menu, I selected the "sell" mode. With this setting, when the batteries are full, the excess energy from the PVs is sold to the utility.

The next week, the digital meter was installed in my 100 amp service base, and I was officially recognized as an off-site power generation station.



The utility meter and lockable disconnect are the only stationary parts of the system.

**Lessons Learned**

A sabbatical provides opportunities for real learning. So what had I learned? First, that it is easy to acquire the technology for innovative renewable energy projects. The expertise for safe installations is readily available and cost effective. Construction time is reasonable—two days for power electronics, one day for 100 amp service, one day for suspension enhancement, and a few days for wood crafting.

I also learned how slow and bogged down the approval process can be. I suspect that it is primarily liability driven. People are reluctant to take responsibility for unfamiliar situations. An amazing fourteen months elapsed between filing the application to provide energy and the installation of the required bidirectional digital meter.

The solar van was featured in two solar home tours organized by the New England Solar Energy Association (NESEA). And I continue to use it as a hands-on component for the power systems courses, sustainability honors courses, general education

**Solar Van System Costs**

<i>Item</i>	<i>Cost (US\$)</i>
Ford Econoline van	\$9,300
Trace SW2512 inverter	2,585
8 Surrette S-460 batteries	1,800
2 AstroPower PV modules, 120 W	1,300
Cables, connectors, switches	933
Partition & battery box	800
Utility service, 100 A	506
Suspension enhancement	405
PE-stamped documents	300
Trace C40 charge controller	285
Trace 250 DC disconnect	275
<b>Total</b>	<b>\$18,489</b>

courses, and continuing education technical courses I teach at the university. The students see the technology in action.

When I show the van at events, I always prepare some food cooked with solar generated electricity. Favorites are hot chocolate, microwave popcorn, and solar smoothies. This hands-on approach to learning complements the classroom activities and makes the information more real.

I continue to explore educational and research uses for the solar van project, and I support all strategies that will safely expedite the approval process for grid-tied PV. It's thrilling to see how easily all this renewable energy technology fits together. My next step is to retire my fossil-fuel-burning auto and use the solar van's electricity to charge a soon-to-be-acquired neighborhood electric vehicle (NEV) for local commutes.

**Access**

Gerald J. Lemay, PhD, Electrical and Computer Engineering Department, University of Massachusetts Dartmouth, 285 Old Westport Rd., North Dartmouth, MA 02747 • 508-999-8535 • glemay@umassd.edu

Sunnyside Solar, Inc., Richard Gottlieb & Carol Levin, 1014 Green River Rd., Guilford, VT 05301 802-257-1482 • Fax: 802-254-4670 sunnysde@sover.net • www.sunnysidesolar.com PV system equipment and installation

ABCO Electric, Inc., Stephen R. Borowicz, 47 Ruby Ct., N. Dartmouth, MA 02747 • 508-999-3008 Fax: 508-993-8688 • abco352@galaxy.net www.abcoelectric • 100 amp service installation

Beatrice Lord, NSTAR Account Executive, 1 NSTAR Way, Westwood, MA 02090 • 800-592-2000 Beatrice\_Lord@nstaronline.com • www.nstaronline.com



*"This book is the solar thermal contractor's bible!"*

## SOLAR HOT WATER SYSTEMS: LESSONS LEARNED 1977 to Today

-- by Tom Lane --

*FINALLY, a definitive how-to book for installing and maintaining high-performance and low-maintenance solar hot water systems -- written by one of the leaders in solar contracting today!*

**AUTHOR TOM LANE** is a pioneer and innovator in the solar energy field. In this landmark book, he outlines how the latest technology and valuable lessons learned from the past can help a new generation of solar contractors expand their businesses and satisfy their customers.

### SOLAR ENERGY SYSTEMS COVERED INCLUDE:

- Detailed system CAD drawings • Each system with manufacturer's components • Drain back • Closed loop glycol • Single and double pumped • Open loop
- Passive ICS and thermosyphon • System testing and monitoring • Solar space heating and hot water system
- Collector and storage sizing • Roofing and flashing
- Manufacturer's component access • Solar pool heating

### FEATURED THIS ISSUE

See "Solar Pool Heating" article, pg. 94, adapted from Tom Lane's book.

Send check or money order today to:

### ENERGY CONSERVATION SERVICES

6120 SW 13th St. • Gainesville, FL 32608

Or, provide credit card & shipping info to:

(352) 377-8866 • tom@ecs-solar.com

Contractor's Edition: \_\_\_\_\_ copies @ \$46 each = \$ \_\_\_\_\_

Homeowner's Edition: \_\_\_\_\_ copies @ \$29 each = \$ \_\_\_\_\_

Shipping & handling: \$ 4.00

TOTAL: \$ \_\_\_\_\_

Name: \_\_\_\_\_ PH: \_\_\_\_\_

Address: \_\_\_\_\_

State/Zip: \_\_\_\_\_



Brushless DC Submersible Pumps up to 2 HP, heads up to 700 feet and flow rates up to 50 GPM.



Diaphragm Submersibles with heads up to 230 feet & flow rates up to 4.3 GPM.



Centrifugal Booster Pumps from 12 volt Home Pressure Systems to 180 volt High Pressure Booster Pump Systems.



Pool Circulating Pumps from 1/2 to 2 HP.



New Micro-processor based pump controllers up to 3 HP.

Current boosting and voltage boosting models available.

We also manufacture: **Jet Pumps**  
**Triplex Piston Pumps**  
**Jack Pump Retrofit Kits**

For free system sizing, technical support, or to place an order call:

Phone: 1-800-370-8115  
(928) 348-9652

Fax: (928) 348-9653

www.sunpumps.com



SunPumps stocks all parts and will rebuild any original SolarJack pump or controller.

**BATTERY CABINETS**

**ROOF & GROUND MOUNTS**

**TOP-OF-POLE MOUNTS**

**BATTERY BOXES**

**POWER-FAB**

**CALL ABOUT OUR FLUSH-TO-ROOF COMPONENTS**

- Power Posts™
- Easy Feet™
- Power Clamps™
- Power Rails™

4000-B Vassar Dr NE • Albuquerque, NM 87107 • **800-260-3792** • Fax 505-889-3548 • Email [jrandall@directpower.com](mailto:jrandall@directpower.com)

*"The generation of a megawatt-hour Begins with a single module."*

# The Basics of RE on CD

A collection of the best RE basics articles from 15 years of *Home Power* magazine.

**Renewable Energy Basics**

Copyright 2002 Home Power, Inc.

**\$29** plus shipping

# Backwoods Solar Electric Systems

For an earth restored and a world at peace. Solar, Wind, Hydro  
 Independent Electric Power for the Remote Home *where utility power is not available.*

When you speak with Backwoods Solar, your questions are personally answered by people using the products everyday. Our catalog / planning guide teaches the basics of installing solar electric residential power. We can refer you to skilled installers in most states. Our mountaintop business, shop, and home have been powered by equipment from our catalog for 25 years. Utility lines are still 2 miles away. We are a family business living with our products.

177 PAGE CATALOG / PLANNING GUIDE  
 FREE to Home Power readers

Phone (208) 263-4290 FAX only (888) 263-4290  
 Website [www.backwoodssolar.com](http://www.backwoodssolar.com)  
 Email [info@backwoodssolar.com](mailto:info@backwoodssolar.com)

Visit us or write:

**Backwoods Solar Electric Systems**  
 1395-HP Rolling Thunder Ridge  
 Sandpoint, Idaho 83864 USA

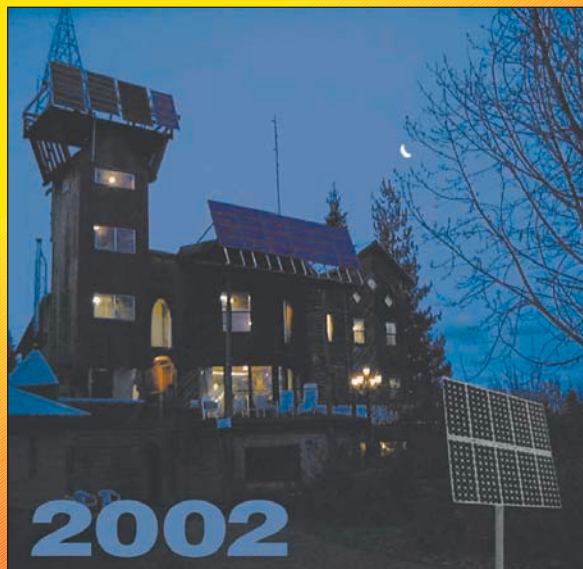

## got solar?...we do!

### Upcoming Workshops Include:

Green Building  
 Technology

Solar Water and Space Heating	April 12	Ashland, WI
Using RETScreen Software	May 1	Milwaukee, WI
Urban Photovoltaics	May 2-3	Milwaukee, WI
10 kW Utility Intertie Wind Installation	May 4-10	Browntown, WI
Batteries and Inverters	May 17-18	Custer, WI
Basic Photovoltaics/PV Site Auditor	May 28-29	Milwaukee, WI
Intermediate Photovoltaics	May 30-31	Milwaukee, WI
Women's Tilt Up Tower Wind Installation	June 8-14	Custer, WI
Advanced Photovoltaic Installation	June 11-17	Central WI



Photovoltaics, Wind, Hydro



Solar  
 Hot Water

*Call or write for more information and course descriptions.*

**Midwest Renewable Energy Association, 7558 Deer Rd., Custer, WI 54423**  
 phone (715) 592-6595 • fax (715) 592-6596 • [info@the-mrea.org](mailto:info@the-mrea.org) • [www.the-mrea.org](http://www.the-mrea.org)

# Solar Pool Heating



## Basics, Part I

Tom Lane

©2003 Tom Lane

Using the sun for more “fun in the sun”—a solar heated pool extends your swimming season with no energy costs.

**T**he primary reasons that we own pools are for family fun, pleasure at home with friends, a healthy and relaxed environment, exercise, and stress relief. A heated pool lengthens the swimming season and becomes a pool that gets used.

Solar pool heating systems are easy, economical, and environmentally friendly. Solar pool heating is perhaps the most cost-effective application of solar energy under the sun. Over 10 million square feet of solar pool collectors were installed for about 33,000 pools in 2001—up 25 percent from 1999. People are catching on that solar pool heating makes good sense.

Solar pool heating systems have distinct differences from the domestic solar water heating applications covered in previous issues of *Home Power*. The larger volume of water, lower temperature requirements, and seasonal use pattern are significantly different design parameters that result in a simpler solar collector at lower unit cost and higher efficiency.

This two-part article will help you extend your pool's comfort season. Part 1 of this article will help owners of residential-sized swimming pools understand how simple, easy, and cost effective solar pool heating is. In addition, basic system components and their functions will be described. Part 2 will discuss the nuts and bolts of sizing solar pool heaters, collector orientation and mounting, installation recommendations, and commercial applications. An extensive list of suppliers is included in the Access section.

**Solar pool panels—roof mounted.**





## Extend the Swimming Season

The solar pool heating season can extend from the last freeze in the spring until the first freeze in the fall. For most people in the United States, an acceptable pool heating season may range from 4 to 6 months long. Only in Hawaii, central and southern Florida, and parts of southern California and Arizona does most of the population expect to swim all year long. In all cases, the relative temperature increase from a solar pool heater over that of an unheated pool will be about the same.

As a crude guideline for comfort, you can expect solar pool heating systems to meet your expectations for swimming during months in which you are comfortable outside, day or night, without wearing a sweater or coat. For months in which you wear a sweater or coat for comfort during the day, you will need a removable pool cover and a backup heater.

## Anatomy & Operation

A solar pool heating system consists of a solar pool collector, automatic control, diverter valve, and associated piping. These components typically work with the pool's existing pump and filter. A backup heater may be incorporated into the system design as well. A pool cover or blanket is a good energy conservation feature to extend the season and to maintain a higher pool temperature.

The typical solar pool heating system is an open loop, drainback design. Pool water is circulated directly through the collectors when the pool's standard

## Typical Solar Pool Heating System

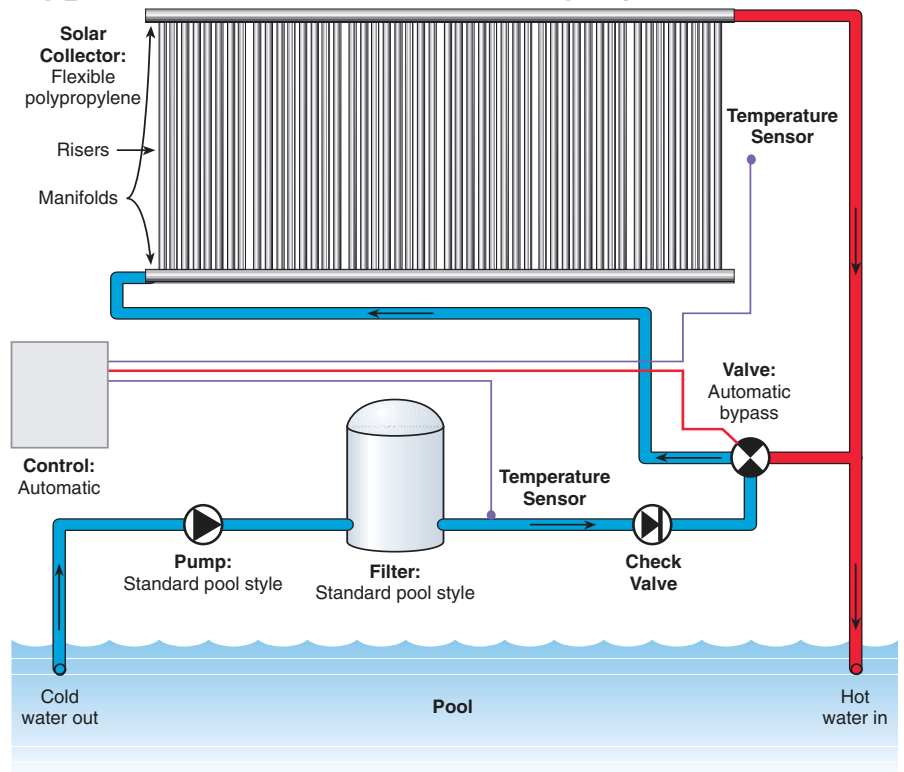

circulation pump is activated. When the pump turns off, the water in the collectors drains back into the pool. A vacuum breaker opens to let air in at the top of the collector. This allows the collectors to drain completely. When the system starts up the next day, it will blow air out of the return lines for a while before the water starts returning from the top of the pool collectors.

Pool pumps are used to filter pool water and are operated on a timer. When used with a solar heating system, the timer is typically set from 9 AM to 4 PM to filter the pool while collecting solar heat. An existing 1 horsepower pool pump can easily circulate the water through solar pool collectors.

An automatic solar controller, called a differential controller, allows you to set the high temperature limit to your comfort level. It is similar to the control used in a solar domestic water heater. It compares the water temperatures measured at the solar collector and the pool. If the collector temperature is at least 4°F (2.2°C) higher than the pool water and the pool is below the desired set point temperature, the control opens the diverter valve. This allows circulation of pool water to the collector and back if the pump is on. A diverter valve in the system either sends the water through the solar collector or straight back to the pool from the pump.

Solar pool panels—ground mounted.



## Example Increase of Swimming Season Using Solar Heating: North Florida

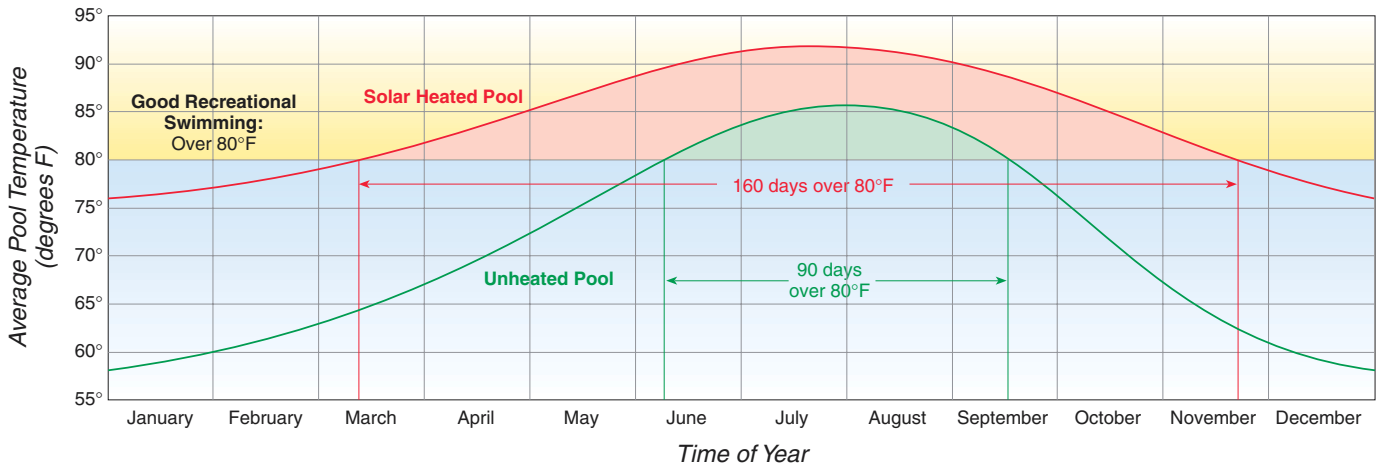

Conditions: 20-year average weather data for North Florida. 1,000 BTU per square foot per day of collector output for a pool in full sunlight; a screened-in pool would typically be 5°F lower year-round. Pool blanket used when night-time temperatures are below 60°F.

During midsummer, if the pool is getting too hot, the pool pump may be operated at night by changing the set points of the controls to use the collectors in reverse to cool the pool water. This strategy is often used with lap pools where a lower temperature can be desirable.

### The components of a solar pool heating system—you may already have many of them.



### Solar Pool Collectors

The main piece of equipment involved in solar pool heating is the solar collector. Collectors for pool heating are different than those used for solar domestic hot water. Most solar pool collectors use an unglazed, plastic, flat plate collector, with no insulated box. The collectors can be mounted on the ground or a nearby roof.

A solar pool heating collector is very simple. The absorber plate is the black surface of the collector, which, like any dark surface in the sun, converts solar radiant energy into heat. The liquid to be heated passes through the risers, which are parallel tubes integrated into the absorber plate. The risers are connected at each end by manifolds, which serve as the collector's inlet and outlet pipes.

Pool collectors are made from EPDM rubber, copolymers, or polypropylene. Absorbers made of EPDM rubber mat are not recommended. They break down over time when subjected to pool sanitizing chemicals like chlorine, bromine, or copper. In addition, EPDM rubber mats cannot be removed and replaced after reroofing, as the other collectors can.

The best absorber materials are made from UV-stabilized, semirigid, plastic copolymer or polypropylene. These pool collectors will typically last from 12 to 20 years. They are available in standard sizes from 4 by 8 to 4 by 12 feet. Narrower collectors 2 and 3 feet wide are used to fit around plumbing stacks and skylights. Aquatherm in New Jersey makes custom sizes up to 4 by 20 feet.

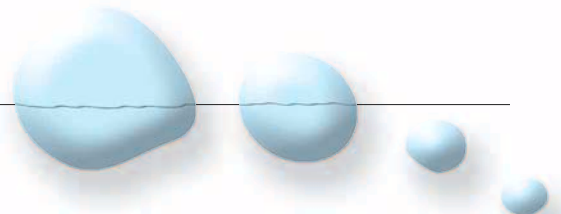

Since plastic does not transfer heat as well as copper, plastic copolymer collectors have more riser tubes than copper absorber plates. A 4 foot wide copolymer collector will have 100 to 150 risers, whereas a copper absorber will have about 10 risers per 4 foot width. In my experience, risers with a round cross-section are more durable than risers with an oval or a rectangular cross-section.

These lower cost, unglazed collectors hold an advantage over glazed, flat plate collectors when used for low temperature pool heating in mild climates. Pool temperatures are usually under 85°F (29°C) and operate during seasons when the air temperature is over 60°F (15.5°C). During months when air temperature is equal to or greater than the desired pool temperature, there is no thermal efficiency advantage to a collector with an insulated box or glazed cover plate. In fact, the opposite is true.

**3 gallons of oil, refined & burned, provides 400,000 BTUs ...once.**

**3 gallons of oil, made into a 4 by 12 foot solar collector, can provide over 10 million BTUs per year...year after year.**

A glazed cover eliminates approximately 15 percent of the thermal energy reaching the absorber plate. When the air temperature is higher than the pool temperature, the glass-covered, insulated box also minimizes heat gain from ambient air and wind. Sealed Air makes a polymer collector in their FW-series that features

a fiberglass glazing cover (called a wind screen) for areas with cold prevailing winds.

Glazed collectors normally used for domestic water heating systems, are much more expensive, and more appropriate for higher temperature end-uses of 120 to 160°F (49–71°C). For pool heating, they are typically used in higher mountain regions, where cold winds prevail, or for indoor winter pool use. For example, in California, glazed collectors will greatly

outperform unglazed collectors on the cold and windy Pacific coast. Glazed collectors, most often used for indoor pools, require more collector area than for outdoor pools. But in cold climates, their operating efficiencies are much higher in winter.

**Cross-Sections of Various Copolymer Pool Collector Designs**

Tube & Web: Author's Preference



Flat Plate: Two variations

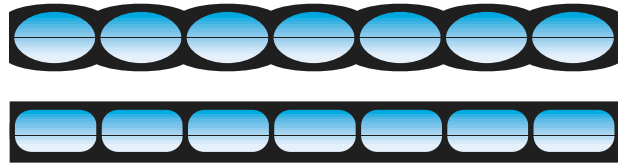

Loose Tube



Welded Tube



To understand the economic sense of using unglazed collectors, consider the Aquatherm Industries 4 by 12 foot plastic copolymer panel, which is rated by the Florida Solar Energy Center (FSEC) to produce 47,200 BTUs per day at 95°F (35°C) inlet temperature. It costs less than US\$250. A typical 4 by 10 foot flat plate collector with a glass cover and copper absorber with 1 inch headers would cost over US\$780 and is rated at 44,900 BTU per day at the same test inlet temperature. For low temperature uses in mild climates, you get more bang for your buck with an unglazed collector.

The less expensive unglazed collectors will match or outperform an equal area of glazed collectors when air temperatures are less than 20°F (11°C) below the desired pool temperature, and the wind speed is less than 5 mph (2.2 m/s). For example, if you want to keep a pool at 75 to 80°F (24–27°C), unglazed collectors will outperform glazed collectors at or above 55 to 60°F (13–16°C) outdoor ambient air temperature during the day. The unglazed collectors would be capable of producing water temperatures of 75 to 85°F (24–29°C) in this example.



You must be extremely careful with copper collector absorbers, glazed or unglazed. Using excessive chlorine with copper collectors will stain the pool blue-green or black.

Finally, when shopping for your collectors, check the warranty details. Some collectors have a warranty against freeze damage. Manufacturers may also offer a ten-year full replacement warranty with a 50 percent lifetime warranty after the tenth year.

### Heating Aboveground Pools

If you think that solar pool heating is only for expensive, inground pools, think again. Smaller solar pool heating systems have become very popular in the northern half of the U.S. over the past five years. Until these newer, low-cost systems became available from SmartPool and other manufacturers, aboveground pool owners had little choice in finding a way to heat their pools. A fossil fuel system can cost almost as much as the pool itself—before the monthly fuel bills start. These smaller (80–160 ft.<sup>2</sup>; 7.4–14.9 m<sup>2</sup>) solar pool heating systems carry a retail price of less than US\$400 and are well suited for a shorter season (Memorial Day to Labor Day), which is when these types of pools are in use.

**Solar heating is perfect for aboveground pools.  
Notice the special serpentine collector flow pattern  
with feed and returns on the same end.  
The time clock is the only control.**



Typically, 4 by 20 or 2 by 20 foot serpentine flow collectors are hose-clamped together to heat the pool. These systems are designed to increase the pool temperature up to 10°F (5.6°C) during the short summer season in the northern U.S. Actually, it is easier to heat an aboveground pool using solar energy for those summer months than an inground pool. The nighttime temperatures stay fairly warm, and aboveground pools tend to heat up more easily. This is because the air is warmer than the ground, and the pool can absorb heat through the sides as well as through the solar pool heat collector.

The cost is lower too, because a manual diverter valve is used rather than a more sophisticated automatic control generally used on larger systems designed for inground pools. Aboveground solar heating systems are usually self-installed and rolled out on the ground next to the pool or put on a homemade rack next to or near the pool, rather than mounted on a roof. All these factors combine to make these systems affordable and very simple to install by the pool owners themselves.

### Cut Your Losses

More than 90 percent of all heat lost from a pool is from a combination of surface evaporation, convection, and radiation. Evaporative losses are usually the greatest, at 70 to 85 percent of total losses. Normally, if wind speeds are less than 4 mph (1.8 m/s), only 10 to 15 percent of the heat loss is by wind or convection. Use screens, shrubbery, or a fence around the pool to help cut wind losses. Radiation losses will be on the order of 5 to 15 percent.

With evaporation responsible for the lion's share of energy loss from a swimming pool, a pool cover is a good investment if you want to extend your swimming season. If you use a pool cover to stop overnight heat losses, a solar pool heating system can maintain a pool approximately 20°F (11°C) over the average air temperature on sunny days. For example, if the average outdoor air temperature is 65°F (18°C), your pool will be about 85°F (29°C) if you use a pool cover to retain heat.

Another strategy to extend your season is to position the pool so that it is in full midday sun during months of use. Also, if you have a screen room over your pool, try to get the widest weave possible. Screen enclosures typically prevent pool temperature gains by from 5 to 10°F (2.8–5.5°C) and even more if the screen accumulates leaves.

### Pool Covers

Pool covers (blankets) make pool heating efficient and effective. Pool blankets are bubble packs that float on the pool's surface when the pool is not in use. A clear pool blanket used with a solar pool system can help you

retain an extra 5°F (2.8°C) when used overnight, and an extra 10°F (5.5°C) when used 22 hours a day. Use a pool cover to extend the swim season in early spring and late fall, and for winter use.

Once nighttime temperatures drop below 60°F (16°C), a pool cover will be necessary for your system to heat the pool to over 80°F (27°C). Pool covers are most important in areas that have average wind speeds over 7 mph (3 m/s) and air temperatures colder than the desired pool temperature. This is true even in the tropics. Always use a pool cover in dry western climates with cold clear nights as well. However, an opaque cover provides little benefit to an unheated pool.

Using a quality reel system, one person can easily roll out a pool cover, even on a 20 by 50 foot (6 x 15 m) pool. Rocky's Reel Systems makes a good residential reel. They have an adapter for use with 4 inch aluminum pipe, 1/8 inch (3 mm) thick, which is usually ordered 24 feet (7.3 m) long—to be cut 2 feet (0.6 m) wider than the pool. These tubes or pipes are available from aluminum supply distributors. This is the best reel for larger pools.

A liquid, time-released pool cover is available at [www.sunsolar.com](http://www.sunsolar.com). It only works with screened-in pools that are shielded from the wind. Using only a thimbleful each day, the liquid is a food additive and nontoxic. It floats on the surface of the water and prevents evaporative losses of your heated pool water.

The practical limit to which you can raise an outdoor pool's temperature (or an indoor pool in an unheated building) with a pool blanket and solar heating system is about 18 to 25°F (10–14°C) above the temperature of an unheated pool. Without the pool blanket, the heating benefit is limited to 13 to 16°F (7–9°C) above the unheated pool temperature.

Heating a pool without a cover is frequently compared to heating a home with the doors and windows open. It takes one BTU to increase the heat of a pound of water by 1°F. For each pound of 80°F (27°C) water you lose to evaporation, considerable energy is required to replace that temperature loss. Pool covers range in cost from US\$0.30 to \$0.50 per square foot and last from 2 to 5 years—a bargain compared to adding additional collectors or using backup heating.



**A simple, retractable pool cover can maintain water temperatures 10°F higher than an open pool.**

#### **Any Other Way to Heat a Pool?**

Solar energy isn't the only way to heat a pool, but it's the most economical. A solar pool heating system with unglazed collectors will cost around US\$8.50 to US\$12 per square foot of collector, depending on the size and system design.

A solar pool heating system with eleven, 4 by 12 panels (528 ft.<sup>2</sup>; 49 m<sup>2</sup>) will cost about US\$4,000 to US\$5,000 installed. Rated at 528,000 BTUs per day, it would produce around 95 million BTUs during an average 6 month pool season. At the U.S. national average, natural gas costs of US\$0.76 per therm, and burned at 80 percent efficiency, it will save more than US\$900 each year.

Considering the fact that a gas heater would cost US\$1,600 to US\$2,000 installed, a solar pool heating system will pay for itself in two seasons. The great news is that people on a limited budget can start with six, 4 by 12 foot collectors rated at 288,000 BTU per day for about US\$2,800 to US\$3,200, and add more as they can afford them. The economics of solar pool heating systems are even more favorable when compared to propane at US\$1.40 a gallon. Heating with propane will exceed the cost of a solar pool heating system in less than one year.

The costs in the table on the next page are for maintaining a 16 by 32 foot (4.9 x 9.8 m) swimming pool at 78, 82, and 86°F (26, 28, and 30°C). Assumed fuel costs are US\$0.76 per therm for natural gas and US\$1.40 per gallon for propane. The costs for traditional means of pool heating in the table appear enormous,

Annual Pool Heating Costs per Water Temperature & Fuel Type<sup>1</sup>

City	78°F		82°F		86°F	
	Propane	Nat. Gas	Propane	Nat. Gas	Propane	Nat. Gas
Atlanta, GA	\$8,608	\$4,252	\$11,331	\$5,977	\$15,054	\$7,437
Boston, MA <sup>2</sup>	3,223	1,592	4,866	2,403	6,686	3,303
Chicago, IL <sup>2</sup>	3,191	1,577	4,832	2,387	6,649	3,285
Denver, CO <sup>2</sup>	3,412	1,685	5,063	2,501	6,892	3,404
Honolulu, HI	541	267	2,331	1,529	5,768	2,850
Houston, TX	5,733	2,832	7,979	3,941	10,970	5,148
Jacksonville, FL	5,571	2,752	7,902	3,903	11,399	5,601
Kansas City, MO <sup>3</sup>	4,278	2,113	6,090	3,008	8,532	4,215
Little Rock, AR <sup>3</sup>	2,676	1,931	4,083	2,017	6,206	3,065
New York, NY <sup>3</sup>	1,796	2,448	7,116	3,515	9,589	4,736
Orlando, FL	3,610	1,783	5,707	2,819	8,602	4,348
Phoenix, AZ	5,476	2,705	7,698	3,882	10,427	5,150
Reno, NV	6,027	2,977	8,296	4,098	10,010	5,340
Sacramento, CA	8,853	4,373	12,100	5,977	15,854	7,832
San Diego, CA	4,067	2,009	10,525	5,119	14,301	7,605
San Francisco, CA	10,393	5,134	13,802	6,819	17,583	8,686
St. Louis, MO <sup>3</sup>	2,596	5,256	7,510	3,170	7,910	3,907
Tacoma, WA <sup>3</sup>	7,066	3,461	9,265	4,576	11,766	5,012

1. Costs are derived from a computer simulation program, Swimming Pool and Spa Operational Costs Calculator, developed by Aquatherm Industries. A number of variables are entered into the calculator, and costs shown do not necessarily represent accurate figures for calculating payback for solar pool heating. Actual costs for specific locations could be as low as 40% of the figures shown with the addition of a pool cover, fuel price variations, and microclimate specifics.

2. Six months, not annual

3. Eight months, not annual

and you might think that your pool heating system will have a rather quick payback. Typically, payback occurs in three to five years (versus a gas heater), but could be as long as seven years, depending on your use patterns and local conditions. The costs in the table do not reflect using a cover over the pool surface to prevent heat losses at night. All costs in the table can be cut by at least 35 percent when using a cover for 12 hours, and 53 percent when used for 24 hours a day.

In addition, the economics of solar pool heating are often confusing to people who think in terms of collector ratings. The FSEC ratings are relative only to boosting and maintaining the temperature rise in a pool under ideal conditions. The FSEC low temperature pool rating is based on testing with a 95°F (35°C) inlet temperature to the collectors, 81°F (27°C) air temperature, and wind speeds of less than 3 mph (1.3 m/s). In most situations, the collectors will far exceed the FSEC low ratings since pool temperatures are not 95°F. Actual performance of a system is dependent on a number of variables that must

be judged subjectively and for each individual microclimate.

To get another view, a computer modeling program that assesses the economics of solar pool heating and other efficiency measures for your pool is available from the U.S. Department of Energy. The free, PC-based software, Energy Smart Pools, can be downloaded from the Energy Efficiency and Renewable Energy Clearinghouse (EREC). However, when it comes to actually sizing your system, most collector manufacturers have more accurate programs to help you out.

**Just Add Water**

A solar pool heating system requires little or no maintenance since there are no burners and no moving parts. You should check the clamps used to connect the solar collectors annually, particularly in hot climates where they may become loose. If you are operating your system year-round, you will need to take precautions during freezing weather conditions.

A gas heater or heat pump requires more maintenance, and generally lasts only one-third the lifespan of a solar pool heating system. Solar pool

heating system warranties are typically more inclusive and much longer (12 years plus) than warranties for gas heaters and heat pump systems (usually 5 years).

In case I have understated the simplicity and good sense of solar pool heating systems, let's recap the high points of this article. Your pool is your storage tank, so you won't need to buy a tank. Your pool already has a pump, so you won't need to buy a pump. The pump is already circulating water through the filter at least 6 hours a day, so you won't need to run it any more than that. Solar pool heaters are inexpensive and operate under conditions of highest efficiency, since several components fulfill dual roles. What else do you need? A collector, a controller, and some pipe—then just add water.

**Access**

Tom Lane, Energy Conservation Services, 6120 SW 13th St., Gainesville, FL 32608 • 352-377-8866

Fax: 352-338-0056 • tom@ecs-solar.com

www.ecs-solar.com • Article adapted from Tom's *Solar Hot Water Systems: Lessons Learned, 1977 to Today*.

Florida Solar Energy Center (FSEC), 1679 Clearlake Rd., Cocoa, FL 32922 • 321-638-1000 or for publications 321-638-1015 • Fax: 321-638-1010 info@fsec.ucf.edu • www.FSEC.UCF.edu • Pool collector ratings

Goldline Controls, Inc., 42 Ladd St., East Greenwich, RI 02818 • 800-343-0826 or 401-884-6990 Fax: 800-343-0827 or 401-885-1500 customerservice@goldlinecontrols.com www.goldlinecontrols.com • Controllers and diverter valves

Pentair Pool Products, 1620 Hawkins Ave., Sanford, NC 27330 • 800-831-7133 or 919-774-4151 Fax: 919-776-4571 • pentair@speedymail.com www.pentairpool.com • Controllers and diverters

Aquatherm Industries, Charlie Grignon, 1940 Rutgers University Blvd., Lakewood, NJ 08701 • 800-535-6307 or 732-905-9002 • Fax: 732-905-9899 aquatherm@aol.com • www.warmwater.com Copolymer collectors

FAFCO, Inc., 435 Otterson Dr., Chico, CA 95928 530-332-2100 • Fax: 530-332-2109 • sales@fafco.com www.fafco.com • Collectors

Sunwest Solar Inc., Sealed Air Distributor, 645 N. Eckhoff St. #M, Orange, CA 92868 • 800-786-8110 or 714-712-6233 • Fax: 714-712-6230 Dbosio123@aol.com • www.sunwestsolar.com Collectors

Heliocol, USA, 927 Fern St., Ste. 1500, Altamonte Springs, FL 32701 • 800-797-6527 or 407-831-1941 Fax: 407-831-1208 • heliocol@umasolar.com www.heliocol.com • Collectors

SmartPool, Inc., 575 Prospect St., Lakewood, NJ 08701 888-560-7665 • info@smartpool.com www.smartpool.com • Aboveground solar pool heaters

Rocky's Reel Systems Inc., 1305 Welch St. #113, North Vancouver, B.C., Canada, V7P 1B3 • 800-663-8705 or 604-985-0525 • Fax: 800-811-9966 info@rockysrollers.com • www.rockysrollers.com Reels and pool covers

Cantar/Polyair, 1100 Performance Pl., Youngstown, OH 44502 • 800-448-2343 or 330-744-8812 Fax: 330-744-1228 • info@cantar.com www.cantar.com • Reels and pool covers

Leslie's Swimming Pool Supplies • 800-275-5882 customerservice@lesl.com www.lesliespoolsupplies.com • Pool blankets

Sunsolar Energy Technologies, 3262 F-X Tessier, Vaudreuil-Dorion, Quebec, Canada J7V 5V5 888-357-6527 • Fax: 450-424-5757 sales@sunsolar.com • www.sunsolar.com Liquid pool covers

Letro Products, 1497 George Dr., Redding, CA 96003 800-223-1695 or 530-247-8181 • Fax: 530-247-8191 customercare@letro.com • www.letro.com • In-line pool thermometers

Energy Efficiency and Renewable Energy Clearinghouse (EREC), PO Box 3048, Merrifield, VA 22116 • 800-363-3732 • doe.erec@nciinc.com www.eren.doe.gov/rspec/software.html • Energy Smart Pools software



# ADVANCED COMMUNICATION SOLUTIONS INC.

***"Specializing in Making Wireless Communications Work"***

***Home Cellular / Radio-telephone / Long range Cordless Systems***

***Cellular Amplifiers / Antennas / In-building Cellular Repeaters***

***Wireless Audio & Video / Gate Intercom & Control Systems***

***Prescott Valley, Arizona • (928) 772-7515***

***www.advanced-comm-solutions.com***

# SunDanzer!



12/24 Volt Refrigeration  
 6 Watt Refrigerators - 19 Watt Freezers  
 5.8 Cu.Ft. Units \$899  
 8 Cu.Ft. Units \$999

[www.sundanzer.com](http://www.sundanzer.com)

1-775-331-6600 hp@sundanzer.com  
 1320 Freeport, Suite 101, Sparks, NV 89431 USA



**SunEARTH inc.**  
 Quality Solar Energy Products

**THINK THERMAL-  
 THINK SUNEARTH**

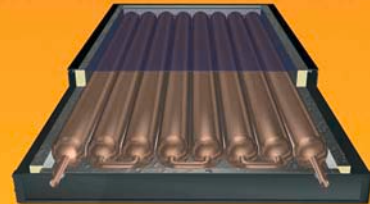

The CopperHeart Integral Collector Storage System

[www.sunearthinc.com](http://www.sunearthinc.com)

**SunEarth, Inc.**  
 4315 Santa Ana Street, Ontario, California 91761  
 (909) 605-5610, FAX (909) 605-5613  
 Distributor inquiries welcome.

## Inverterrepair.com

is excited to announce  
 the addition of our latest team member,  
 Mr. Steve Higgins.



Steve brings with him  
 many years of experience as a senior  
 technician with one of the world's most  
 reputable renewable energy product  
 manufacturers. His expertise greatly  
 enhances our ability to offer our  
 customers the best service in the industry!

If you're looking for fast, affordable multibrand  
 inverter repair performed by expert technicians,  
 using the latest state of the art test equipment, visit:

[WWW.INVERTERREPAIR.COM](http://WWW.INVERTERREPAIR.COM)

or call 1-866-52-FIXIT

or 1-888-647-6527

Solatron Technologies

"Bringing you the power of the sun  
 at down to earth prices!"



## Solar Installer Training Classes



for Contractors, Electricians, &  
 Affordable Housing Affiliates



\$50 - \$100 tuition

March - August,  
 2003

One-day classes  
 throughout  
 California

provided by the  
 Real Goods Solar  
 Living Institute

Call 707.744.2017 to register, see  
[www.solarliving.org](http://www.solarliving.org) for details and request a  
 free catalog of over 60 classes on renewable energy,  
 green building and sustainable living.

*Made possible by a Renewable Energy Consumer Education  
 grant from the California Energy Commission*



# SOLAR BOOST™ MPPT CHARGE CONTROLLERS

**PATENTED MPPT TECHNOLOGY INCREASES CHARGE CURRENT UP TO 30% OR MORE!**

• **New Solar Boost 6024H** - provides a cost effective solution for installations where the PV array must be located far



from the batteries and charge controller. High voltage input reduces both wiring expense and wiring power loss.

PICTURED WITH OPTIONAL DIGITAL DISPLAY

**RV POWER PRODUCTS**  
PROVIDING ELECTRICAL INDEPENDENCE

- **Special High Voltage Input design accepts 36V or 48V Solar Module Arrays**
- **Charges 12V or 24V Batteries At Up To 60A Output Charge Current**
- **Three Stage Charge Control**
- **Additional products available**

RV Power Products -  
The recognized leader in  
quality MPPT charge controllers.

Manufactured by RV Power Products and offered by a large network of quality distributors and dealers. Call us today for information or a dealer near you.

Visit our web site at [www.rvpowerproducts.com](http://www.rvpowerproducts.com)  
or e-mail to [info@rvpowerproducts.com](mailto:info@rvpowerproducts.com)

800-493-7877 or 760-597-1642  
2598 Fortune Way, Suite K, Vista, CA 92083



## hupsolarone.com

There Is A Difference!

### LIVE OFF THE GRID NEAR LAKE TAHOE

18.8 acres - 3BR/2BA Home  
1BR/1BA Guest House - Views  
Solar/Wind/B-up Gen  
\$645,000

Prudential California Realty  
Don & Sylvia Leutz, CA/NV Realtors,  
Toll Free: 1-866-541-2200 • [www.TahoeHomesandMore.com](http://www.TahoeHomesandMore.com)



**PROVEN**  
PROVEN WIND TURBINES

**Reliable • Quiet • Rugged • Elegant  
Wind Turbines**

As seen in *HP 90*, pg 50  
Dealer Inquiries Welcome



**Solar Wind Works, USA Distributor**

Toll Free! 877-682-4503

PO Box 2511, Truckee, CA 96160

[proven@solarwindworks.com](mailto:proven@solarwindworks.com) • [www.solarwindworks.com](http://www.solarwindworks.com)

Proven Engineering Products Ltd, International  
[www.provenenergy.com](http://www.provenenergy.com) • Tel +44 (0)1563 543 020



**We've reduced  
our energy use  
even further!**

**Need a High Efficiency Refrigerator  
for a Harsh Climate?**

**SUN FROST**

P.O. Box 1101, Arcata, CA 95518-1101

Phone: 707-822-9095 • Fax: 707-822-6213 • [www.sunfrost.com](http://www.sunfrost.com)

# Quick Start

## Home Power Subscription Special



Save  
**\$36**

6 most recent  
available  
back issues...  
**Sent Now!**



And...  
6 future issues  
as a subscription...  
**Bimonthly!**

**\$45**

S&H US\$5  
Call for Int'l prices.



**800-707-6585 • 541-512-0201**  
**www.homepower.com**

PO Box 520, Ashland, OR 97520 USA



**\$64**

S&H US\$5  
Call for Int'l prices.

# Quick Start

## Plus 1 Sub Special & Basics CD-ROM

Same as the  
Quick Start at left,  
plus...**Solar1**  
**CD-ROM!**

Save  
**\$46**



The best articles on the  
basics of renewable energy  
from 15 years of *Home Power* magazine. Full color,  
indexed, searchable, printable. Basics video clips too.

## Visit Our New Web Site!

Same Great Info, Lots of New Features  
**www.homepower.com**  
As always, download our current issue for FREE!

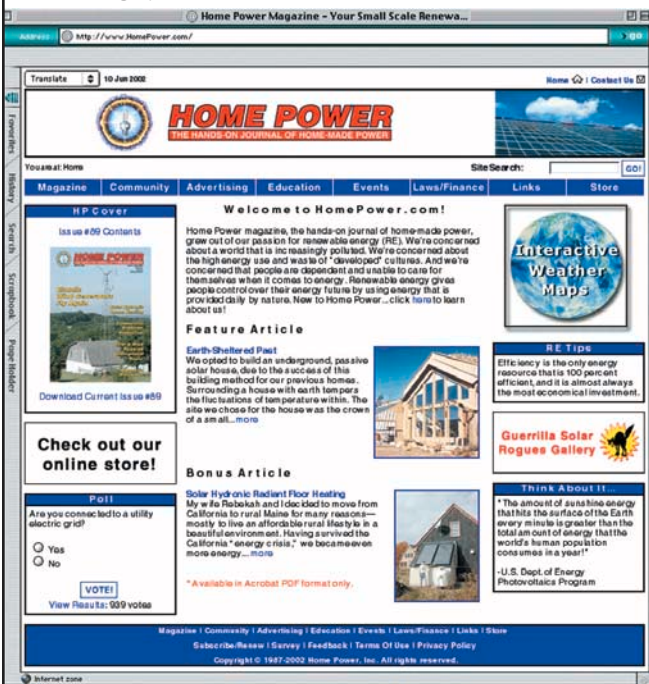

100% Cotton  
Good Shirts!

# T-Shirts

Sizes:  
S, M, L, XL, XXL

Full Color  
on Natural Shirt  
**\$15.00**



Shipping:  
\$5 USA,  
\$8 Canada,  
\$10 International

**To Order Call: 800-707-6585**  
(541-512-0201 Outside USA)

Or see our web site:  
**www.homepower.com**

Or send check or money order to:  
**Home Power Magazine**  
PO Box 520, Ashland, OR 97520





# Home Power's Business



"The man who on his trade relies, Must either bust or advertise."

Sir Thomas Lipton — 1870

## First Class Subscription:

[subscription@homepower.com](mailto:subscription@homepower.com)

Get 6 issues of *Home Power* magazine via First Class U.S. Domestic Mail for \$43. All First Class issues are shipped in an envelope. We start your subscription immediately with the current issue.

## Publishers Periodical Subscription:

[subscription@homepower.com](mailto:subscription@homepower.com)

Get 6 issues of *Home Power* via Publishers Periodical U.S. Domestic Mail for \$22.50. This will be forwarded for one issue (two months), so let us know immediately if you move! Please allow up to ten weeks for your first copy to arrive.

## International Subscriptions:

[subscription@homepower.com](mailto:subscription@homepower.com)

### 1 Year (6 issues) International Rates:

Anywhere in the world: Surface — \$30  
Air — Check our Web site, e-mail, or call for pricing.

## Back Issues:

[order@homepower.com](mailto:order@homepower.com)

Back issues through #20 are \$6.25 each while they last. Back issues of #21–45 are \$7.75 each. Back issues #46–84 are \$8.75 each. Back issues #85 to present are \$9.95 each. (Sorry, no more issues #1–12, 14, 15, 35, 36, 38, 40, 41, 59–67, 79, 81–83, & 87.) Back issues are shipped First Class mail to U.S., Air to International. See the listing under Ad Index on the last page for details and current *Home Power* back issue specials.

Issues #1–42, 43–60, 61–70, 71–76, 77–82, & 83–88 are on CD-ROMs for \$29 each (Shipping: \$2 in US; Canada \$3; International \$4).

## Home Power Magazine for Resale:

[bizoffice@homepower.com](mailto:bizoffice@homepower.com)

Quantities of *Home Power* magazine are available for resale by distributors, newsstands, bookstores, energy businesses, and others. Please call, e-mail, or write for rates and shipment specifics.

**Display Advertising:** [advertising@homepower.com](mailto:advertising@homepower.com)

### Color Advertising Rates per Consecutive Insertion

	Single Insertion	Three Insertions	Six Insertions
Full Page	\$2,350	\$2,115	\$1,978
Half Page	\$1,292	\$1,163	\$1,088
Third Page	\$913	\$822	\$770
Quarter Page	\$713	\$641	\$601
Sixth Page	\$501	\$450	\$422
Eighth Page	\$398	\$358	\$336
Twelfth Page	\$277	\$249	\$234

For inserts, and current subscriber/circulation demographics or a media kit, please call us.

*Home Power* is published bi-monthly. The ad deadline for the June / July issue (HP95) is April 1, 2003. Call 541-512-0201 or 800-707-6585 for further details.

**Web Site Advertising:** [advertising@homepower.com](mailto:advertising@homepower.com)

*Home Power* offers banner advertising on our Web site! Contact Connie Said at 800-707-6585 or 541-512-0201 or [advertising@homepower.com](mailto:advertising@homepower.com)

### Web Site Banner Advertising Rates per Page View

	Size in pixels	25,000 page views	50,000 page views	100,000 page views
Zone I	468 w by 60 h	\$1,000	\$2,000	\$4,000
Zone II	150 w by 100 h	625	1,250	2,500
Zone III	150 w by 50 h	375	750	1,500

If you have technical questions regarding the digital formatting for banner ads, please contact our Director of Information Services, Rick Germany at [rick.germany@homepower.com](mailto:rick.germany@homepower.com)

**MicroAds:** [micros@homepower.com](mailto:micros@homepower.com)

MicroAd rates are 25¢ per character. Characters include numbers, spaces, and punctuation. \$20 minimum per insertion (includes both print and Web). Send a payment with your ad. We do not bill MicroAds.



**Home Power, PO Box 520, Ashland, OR 97520 USA**  
**Subscriptions & Back Issues: 800-707-6585 or 541-512-0201**



Advertising: [advertising@homepower.com](mailto:advertising@homepower.com) • Editorial: [hp@homepower.com](mailto:hp@homepower.com) • [www.homepower.com](http://www.homepower.com)



# TOP SECRET

GUERRILLA SOLAR:  
The unauthorized  
placement of  
renewable energy  
on a utility grid.

PROFILE: 0025

DATE: February 2003

LOCATION: Slovenija

OWNER NAME: Classified

INSTALLER NAME: Classified

INTERTIED UTILITY: Classified

SYSTEM SIZE: 120 watts of PV

PERCENT OF ANNUAL LOAD: 25%

TIME IN SERVICE: 10 months



Solar guerrillas on the apartment building roof.

I decided that I would like to be a proud member of the world's solar guerrillas. Why guerrilla? Because I live in an apartment block in an urban city and my retired neighbors will never, ever understand me. They are afraid of everything! For that reason, I had to put my photovoltaic array on the roof of our building without approval of my neighbors, or the utility.

After a few weeks, one of my neighbors stopped me and asked, "What the hell are you doing on the roof? It must be something strange, because I'm having problems with my TV reception!" I answered, "That's just my new weather station, and you probably have problems with your TV because your washer isn't grounded properly!" After this meeting, I didn't have any more problems.

My system is grid-interactive, which eliminates the need for a battery bank and its energy losses. I like the feeling that on nice sunny days, I can share clean, renewable energy with my retired neighbors. This feeling is better than watching the utility meter spin backwards! If they only knew, if they only knew... What a great feeling!

I was lucky, because our apartment building has a flat roof and I have enough space to put the array anywhere. The only thing I had to make was a wooden stand, which I adjust for the summer and winter seasons.



The author on his "green" Peugeot electric scooter.

My system includes two Siemens SP75 (75 watt, 12 VDC) photovoltaic (PV) modules totaling 150 peak watts and a Soladin 120, grid-intertied, 220 V, 50 Hz inverter. This inverter is made by MasterVolt Solar B.V. in the Netherlands. Peak output power is 120 W, and cost was US\$160.

This inverter requires a 24 VDC input, so I wired the two modules in series for 150 rated watts at 24 volts. The AC



The Soladin 120 inverter plugged into the wall socket.

output of the inverter is plugged directly into one of my household receptacles. The inverter's output is protected by a 1 amp internal AC breaker. The inverter is designed to go off-line in a matter of milliseconds if the grid fails.

The Soladin 120 works very well, and in my opinion, it is the best small grid-intertied inverter on the market. The only thing I miss is a computer interface for collecting data. The inverter makes only a slight buzzing sound. It has a green LED that flashes to show how strong the output is. The faster it flashes, the lower my monthly utility bill will be, hour after hour, day after day...

The system components were very expensive. On the other hand, it's my hobby, and it makes me happy. And that's important! With this green energy, I also charge my Peugeot electric scooter, via an AC receptacle in my apartment. Now I can claim that my scooter runs with zero emissions! And that's the thing that really works!

**Access**

Mastervolt, Snijdersbergweg 93, 1105AN Amsterdam Z.O. The Netherlands • +31-20-3422180  
 Fax: +31-20-3422188 • solar@mastervolt.com  
 www.soladin.com • www.mastervolt.com



**Guerrilla Solar Defined**

Energy is freely and democratically provided by Nature. This century's monopolization of energy by utilities both public and private threatens the health of our environment. Solar guerrillas believe that clean renewable energy should be welcomed by utilities. But utilities and governments continue to put up unreasonable barriers to interconnection, pushing common citizens to solar civil disobedience.

Guerrilla systems do not endanger utility line workers (see HP71, page 58). They share clean, renewable energy with others on the utility grid, and reduce the need for polluting generation plants. When interconnection for small-scale renewables becomes fair, simple, and easily accessible to all, there will be no more need for guerrilla action.



**The Wattsun AZ-225 Solar Tracker:**

2 KW on a Single Pole! Array Technologies is proud to introduce the Wattsun AZ-225 Dual-Axis Tracker Drive. With standard PV modules, the Wattsun AZ-225 Tracker can rack over 2 kW of PV power on a single mount. The heart of the AZ-225 tracker is an industrial grade, worm-gear motor drive. The AZ-225 components are made of heavy-duty steel, cast iron and a premium quality ball bearing gear drive assembly that supports a sturdy aluminum module mounting frame.

Array Technologies, Inc.  
 3312 Stanford NE  
 Albuquerque, NM 87107

Phone: 505-881-7567  
 FAX: 505-881-7572  
 URL: www.wattsun.com

**T-SHIRTS**

**Guerrilla Solar**

**Install by Night—Power by Day**

**On Black: \$15, or Camo: \$18**  
 Shipping: \$5 USA, \$8 Canada, \$10 International  
 Call, see our web site, or send check or money order  
**800-707-6585** (541-512-0201 Outside USA)  
[www.homepower.com](http://www.homepower.com)  
**Home Power, PO Box 520, Ashland, OR 97520**

# Harris Hydroelectric

Hydro-Power for Home Use

Introducing a new adjustable Permanent Magnetic Brushless Alternator

- 25 - 30% more efficient than Hi Output Alternator
- Marine Grade Construction throughout
- Re-connectable Stator
- Retrofittable on existing turbine

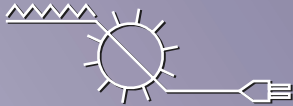

632 Swanton Road  
Davenport, CA 95017  
831-425-7652



**NEW!**

[www.harrishydro.com](http://www.harrishydro.com)

RENEWABLE ENERGY  
DESIGN, SALES,



AND COMPLETE  
INSTALLATION

Complete Service: We do solar, wind, solar hot water, radiant floor systems, and stand alone well pump systems. Site survey, load analysis for both heating and PV-wind systems.

Quality and competitive prices and service long after the sale.

Serving New Mexico & Southern Arizona.

[www.positiveresources.net](http://www.positiveresources.net) • 505-430-7705

**solarsolar.com**

**877-657-6527**

# Back Home

Your Guide  
to Self-Reliant Living

MAGAZINE

Take control of your own life. Thousands of people have gone BACKHOME to enjoy less complicated, more rewarding lives . . . and you can join them. In each bimonthly issue, find articles on topics such as: Alternative Home-Building Techniques, Organic Gardening, Selecting a Home Business, Living Mortgage Free, and much, much more!



Subscribe to BACKHOME for just \$21.97 per year. Call us at 800-992-2546, write to us at P.O. Box 70HP, Hendersonville, NC 28793 or visit our Web site

[www.BackHomeMagazine.com](http://www.BackHomeMagazine.com)

## RENEWABLE ENERGY with the EXPERTS

An Instructional Video Series on the Basics of Residential Renewable Energy

**Residential Solar Electricity with Johnny Weiss**, 48 min.

**\$39.95 each**

Johnny Weiss is one of the founders and teachers at Solar Energy International, in Carbondale, CO.

**Residential Wind Power with Mick Sagrillo**, 63 min.

Mick Sagrillo has installed and repaired over 1,000 wind turbines.

**Residential Microhydro Power with Don Harris**, 44 min. Don Harris has designed and manufactured over 1,000 microhydro power plants.

**Batteries with Richard Perez**, Editor in Chief and founder of Home Power magazine.

**Solar Water Pumping with Windy Dankoff**, 59 min. Windy Dankoff has been designing and installing solar-powered water pumping systems for 15 years.

Shipping \$5 USA, \$6 Canada, \$10 International

**Home Power, Inc., PO Box 275, Ashland, OR 97520**  
toll free in USA: 800-707-6585 • 541-512-0201

Fax: 541-512-0343

Web: [www.homepower.com](http://www.homepower.com)

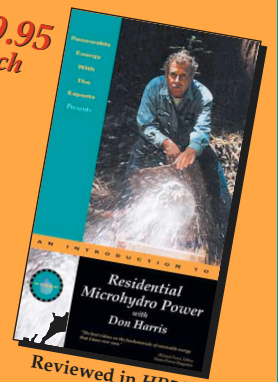

Reviewed in HP56

Solar Panels • Wind Turbines • DC Lighting



**ABS Alaskan, Inc.**

Alternative Energy & Remote Power

2130 Van Horn, Fairbanks, AK 99701

toll free: 800-235-0689 fax: 907-451-1949

visit us online: [www.absAK.com](http://www.absAK.com)

Alaska Battery Anchorage, AK ph: 907-562-4949 fax: 907-563-4900  
Distribution Center Renton, WA ph: 425-251-5745 fax: 425-251-5748

Micro Hydro • Complete Systems • & More



**Meridian**  
energy systems, inc.



Residential and Commercial Systems Design, Sales and Installation  
[www.meridiansolar.com](http://www.meridiansolar.com)

Austin, Texas (512) 477-3050

**DRIVE VEGETARIAN!**



**greasecar.com**  
vegetable fuel systems



Kit converts  
any diesel engine  
to run straight  
vegetable oil!

Visit [greasecar.com](http://greasecar.com) or call (413) 586-2432

## MORNINGSTAR Solar Controllers...

### MARKET LEADER:

- Over 300,000 controllers sold
- Global presence with authorized Morningstar distributors located in 57 countries

### TECHNOLOGY LEADER:

- Innovative design technology provides high value features at lowest possible cost
- Advanced manufacturing technology provides consistent quality and 100% functional testing

### PERFORMANCE LEADER:

- Failure rate of less than 2 per 1,000 units shipped
- Highly efficient PWM series controllers increase battery capacity and life



1098 Washington Crossing Road  
Washington Crossing, PA 18977 USA  
Phone: 215-321-4457  
Fax: 215-321-4458  
[info@morningstarcorp.com](mailto:info@morningstarcorp.com)  
[www.morningstarcorp.com](http://www.morningstarcorp.com)



PROSTAR™



SUNSAVER™



SUNLIGHT™



SUNGUARD™

The Trimetric  
Model 2020

## BATTERY SYSTEM MONITOR

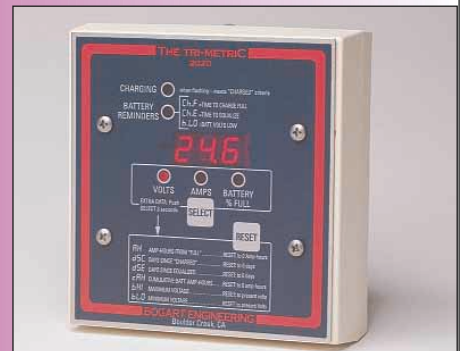

Displays vital battery system data to help users provide better battery care, increase conservation awareness and aid system maintenance.

- Volts • Amps • Amp-hours • Min/Max volts
- Days since charged • Battery % full
- Remote locatable • More !

Bogart Engineering • (831) 338-0616

[www.bogartengineering.com](http://www.bogartengineering.com)

19020 Two Bar Rd. Boulder Creek, CA 95006 USA

# What the Heck?

4



A disconnect in the off position with a padlock to prevent it from being turned on.

## Disconnect

**Used In:** PV systems, electrical systems of all types

**AKA:** Switch, breaker, cord and plug, disconnecting means

**What It Is:** A device used to shut off power to electrical equipment

**What It Ain't:** Two politicians debating

Disconnects come in more than one flavor, but most often, it is a fancy word for a switch. When a switch is used for safety purposes, it is called a disconnect. Whenever someone is working on an electrical device (pump, control, motor, etc.), a disconnect provides a means to de-energize it.

Approved disconnects for smaller nonportable devices and portable tools and appliances can be as simple as a cord and plug. Power tools, lamps, and appliances will usually have both a disconnect (the cord and plug) and a switch to turn them on and off. A disconnect that is used for safety is often required to be within sight from the equipment that it de-energizes.

On the disconnect in the picture, you will notice a padlock near the handle. Many disconnects have a provision for a lock that an electrician will place on the switch to ensure that no one turns it on while the equipment it protects is being worked on. Some disconnects are circuit breakers, and some can contain fuses.

Chuck Marken, AAA Solar Supply Inc. • info@aaasolar.com



- Interactive web site for members
- Latest news about Earth-friendly cars
- Inside scoop from green car owners
- Club events - Annual rally and more

**Be Part of the Solution  
Join the Club  
Its Free!**

Organized by  
Northeast Sustainable Energy Association

Illinois Renewable Energy Association



Illinois Solar Energy Association

Make the Commitment  
2nd Annual  
Illinois Renewable Energy Fair  
August 9 and 10, 2003  
Oregon, Illinois Ogle County Fairgrounds



Bob and Sonia Vogl  
815 732 7332  
sonia@essex1.com  
www.illinoisrenew.org



## SOLAR ELECTRIC WORKSHOP IN COLORADO!

Presented by:



THE POWDERHORN INSTITUTE



Guest Instructor: Richard Perez,  
RE Expert & Publisher, Home Power Magazine

Please join us **July 14-19, 2003** at the  
Cebolla Hot Springs Ranch in Powderhorn, Colorado



- \* Basics
- \* Grid-tie
- \* Off-grid
- \* Sizing
- \* Design
- \* On-site installation
- \* Lively Discussion
- \* Networking

For Complete Workshop Information:  
Please go to [www.powderhorn.org](http://www.powderhorn.org) or call  
(970) 641-7088 / FAX (630) 214-6714

## New England's Renewable Energy Festival July 12 & 13, 2003

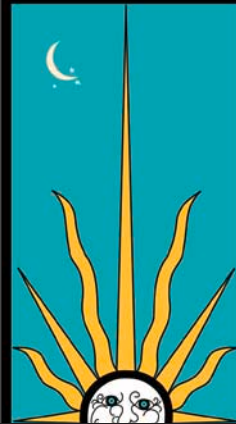

Solar Stages

Workshops

Vendors

Green Mountain College  
Poultney, Vermont

[www.solarfest.org](http://www.solarfest.org)  
802.235.2866

# SOLARFEST

ENERGY EDUCATION THROUGH THE ARTS

5<sup>th</sup>  
Annual

# SOL WEST

Renewable Energy Fair

Over 50 exhibit booths  
and more than 40  
workshops included  
with fair entry!  
Pre-fair workshop:  
off-grid system  
installation.

Your Energy Fair  
for the Northwest  
and Inland West!

## July 25-26-27, 2003

Grant County Fairgrounds

John Day, Oregon

SolWest/EORenew, PO Box 485, Canyon City,  
OR 97820, 541-575-3633, [info@solwest.org](mailto:info@solwest.org),  
[www.solwest.org](http://www.solwest.org)



## The Southwest Renewable Energy Fair

August 8, 9 & 10 ~ Flagstaff, Arizona

Power Up - Solar, Wind & Biomass Technologies  
Build Green - Green Building Products & Design  
Drive Clean - Alt-Fuel Vehicles

Friday, Aug 8 ~ Industry Day

Business-to-business topics: Technology updates, dealer programs, business development, policy issues.

Saturday & Sunday, August 9 & 10 ~The MAIN EVENT!

Product and Technology Expo. Workshops, Seminars, Demonstrations & Tours. Keynote. Kids Fair & More!

The Southwest Renewable Energy Fair

[www.GFEC.org/SWREF](http://www.GFEC.org/SWREF)

Produced by the Greater Flagstaff Economic Council

# Wind Generator Ups



**A Tower Disaster**

## and Downs

**Bruce Johnson**

©2003 Bruce Johnson

**Above:** A 54 foot tall steel tower doesn't just go down gracefully, but nobody was hurt and the PV panels survived by inches.

**Left:** The Whisper H-900 took things in stride, with one broken blade, a smashed nose cone, and a bend in the tailpipe. Soon it will fly again.



I want to share our experience with a wind generator tower failure. Maybe it will save someone else from a similar experience.

I put up the 54 foot (16.5 m) tower in 1979. It was an old tower from a water pumping windmill. For most of its life, this tower supported an old Wincharger. The negative pole of the generator was grounded to the tower. The tower was bonded to a ground rod driven into the soil at the base of the tower. In 1997, we replaced the Wincharger with a Whisper H-900.

### **Tower Down!**

In March 2002, the tower blew down in a 60 mph (27 m/s) wind. Inspection showed that all four legs were completely and uniformly rusted off right at the surface of the soil. The tower and the legs in the ground were 2½ inch (6.4 cm), galvanized steel, angle iron.

The tower legs were in the ground 5 feet (1.5 m), with concrete in the bottom 2 feet (0.6 m) of the hole. So 3 feet (0.9 m) of the tower steel was in direct contact with the soil. I inspected down 1½ feet (0.45 m) after the failure, and the steel is a black color and badly pitted. The above-ground steel was starting to rust some, but it was dramatically worse below ground level.

Inspection of our nearby water pumping windmill that was erected in 1978 showed the legs at the soil surface to be perfectly sound. The water pumper tower is shorter, just 32 feet (10 m), but the installation is identical to the failed wind genny tower. I also inspected it down 1½ feet, and the galvanized steel looks almost as good as new, with no sign of rust or corrosion.

Our soil is very sandy for the top 2 feet (0.6 m), and then it becomes a very soft sandstone. We know from our gardening experience that it is an acidic soil. Garden tools left in contact with the soil start to rust within hours. We are in a low spot, so the ground is usually damp. But I wondered if some type of galvanic corrosion had occurred with the wind genny tower. Both towers were built with similar, used steel, salvaged from old towers in our area.

### Electrolysis

I found an article in *HP25* about grounding that confirmed my suspicion that galvanic corrosion was the culprit. In that article, Mick Sagrillo and Richard Perez said:

*One final argument against grounding the negative leg of a wind system is the problem of electrolysis. A common practice of wind generator manufacturers in the 1920s and '30s was to ground the negative leg of the wind generator to the tower. This saved some materials in a highly competitive fledgling industry—only two slip rings and two slip ring brushes were needed, one for the positive and one for the field. The negative line of the machine was connected directly to the tower. The negative was then picked up at the tower's base and three wires—negative, positive and field—were brought into the house to the control panel.*

*After a decade or so, many of these towers began falling over. Close inspection of the tower at ground level revealed that the metal there was soft and spongy. The voltage in the tower leg set up a weak battery with the earth. Slowly, metal ions would disassociate from the tower and migrate from the tower legs into the earth. The tower became weakened at the soil line and eventually fell over.*

I consulted with Mick Sagrillo, and he relayed a recent story about a similar tower failure on a project in North Korea. One of the slip rings shorted to ground, so there was electron flow through the tower, causing electrolysis. His description of the metal failure made it sound exactly like what I saw on my tower.



**All four tower legs looked like this—completely and squarely rusted off, right at ground level.**

Hindsight is a great teacher. I would have saved myself a lot of grief if I had poured the concrete tower footings all the way above grade and then tapered the top slightly to drain water away from the tower legs. This probably would have prevented the tower from going down. The other thing I could have done would have been to inspect the tower legs. Five minutes with a spade would have revealed that there was a serious problem. If I had caught it in time, I'm sure I could have come up with a solution. And I wouldn't tie the negative conductor to the tower again, of course.

**A birds-eye view of the downed tower and smashed shed roof.**



### Back on the Horse

We are about to get the machine back in the air, this time on a 65 foot (20 m) tilt-up, guyed tower. I bought the Southwest Windpower kit, and it seems to be very well engineered. I'm using some very stout, heavily galvanized anchors that I got from a local broadcast tower company.

Much to its credit, the Whisper survived its trip through the shed roof with relatively little damage—one broken blade, a smashed nose cone, and a bend in the tailpipe. Needless to say, I was pretty impressed. The PVs have kept us well supplied with juice since the tower went down, but it will be great to have the Whisper flying again.

## Tower Disaster

### Access

Bruce Johnson, 7605 N. Post Rd., Spencer, OK 73084  
405-771-3551 • See other articles by Bruce in *HP20*,  
*HP40*, *HP53*, and *HP70*.

Kansas Wind Power, 13569 214th Rd., Holton, KS  
66436 785-364-4407 • Fax: 785-364-5123  
www.kansaswindpower.net • 65 foot, SWWP tilt-up  
tower kit for • H-40/H-80 wind generators





# Alternative Energy STORE

Making Renewable Affordable™

**Sample of Specials**

**Ready to go Grid-Intertie? Call us!**

- We offer **LOW PRICES** on all the equipment you need
- We'll help customize a system to meet **YOUR NEEDS**

**Photowatt 160W Total - Only \$558!**

- Polycrystalline, 12V
- 25 Year Warranty
- Made in the U.S.A.

Toll Free: +1.877.878.4060 • Fax: +1.877.242.6718 • Email: Sales@AltEnergyStore.com  
[www.AltEnergyStore.com](http://www.AltEnergyStore.com)

**Only \$3.49 per Watt!**



ASE       

## ELECTRIC CAR COMPONENTS & KITS

- \* **Reliable, Affordable Components**
- \* **Large Library of Adaptors**
- \* **Most Experienced Tech Support**
- \* **Design Assistance**

### Conversion Kits:

- \* **Basic & Deluxe Universal Kits**  
Contain all drive system components.  
You add mounts, boxes, etc. to fit your model.
- \* **Complete Custom Bolt-In Kits**  
Voltsrabbit for VW Rabbit, and Voltsporsche for Porsche 914. Completely prefabbed. No design or welding necessary. Kit includes everything except donor car and batteries.

For Catalog, Send \$6.00 To:

**ELECTRO AUTOMOTIVE**  
**PO BOX 1113-HP**  
**FELTON, CA 95018**



[www.electroauto.com](http://www.electroauto.com)

(OUTSIDE U.S. & CANADA, ADD \$5.00)

## Umpqua Community College's ALTERNATIVE ENERGY FAIR

### with Douglas County's EARTH DAY CELEBRATION

Douglas County Fairgrounds  
Roseburg, Oregon

April 26, 2003 • 10:00 AM - 4:00 PM

The fair will feature speakers, booths, & exhibits covering solar energy, fuel cells, home owner concerns, electric cars, conservation, power company energy options, and featuring *Home Power's* own Richard Perez as the keynote speaker with an overview of living on renewable energy. These subjects as well as many others will be covered throughout the fair.



For information call  
(541) 440-4601 or  
E-mail [bonniej@mcsi.net](mailto:bonniej@mcsi.net)

## Use Your Head!

### Harness the Power of Low-Head Hydro

Manufacturer of Nautilus, Neptune,  
Niade & Waterhorse turbines.

Importer of Power Pal turbines  
& HydroMax controllers.

Run  
your home  
on five feet  
of head!



## NAUTILUS Water Turbine, Inc.

2131 Harmonyville Rd.,  
Pottstown, PA 19465

610.469.1858  
Fax: 610.469.1859

[www.waterturbine.com](http://www.waterturbine.com)

Dealer  
inquiries  
welcome

# SOLARx2

THE LARGEST USE OF SOLAR ENERGY FROM THE LEADING MANUFACTURER IN THE USA

Swimming pool heating is the leading use of solar energy in the world, it's no wonder this market is HOT.

For nearly three decades, Aquatherm Industries has Set the Standard in solar pool heating, supplying dealers with residential and commercial pool heating systems from coast to coast, as well as abroad.

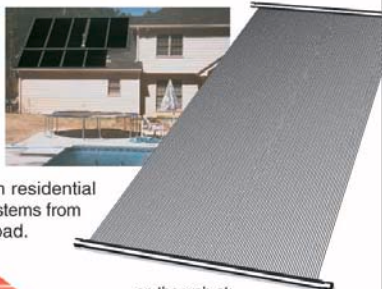

**aquatherm**  
INDUSTRIES, INC.

on the web at:  
[www.warmwater.com](http://www.warmwater.com)  
or call us at:

**1-800-535-6307**

Call us today to find out how our years of solar pool heating experience can improve your profit level.

# We Mean Business . . .



## Our #1 Priority: Customer Service

The SunWize Customer Service Team provides the prompt personal attention you deserve. Courteous . . . Helpful . . . Friendly . . . offering assistance to fulfill your order. We are the people that make it happen for your business. Be successful, choose SunWize!

**SunWize**<sup>®</sup>  
TECHNOLOGIES

800.817.6527 • [www.sunwize.com](http://www.sunwize.com)



## The Book on Solar Cookers

*Back by Popular  
Demand*

A second edition,  
fully updated  
and revised.

*Includes:*

- A history as well as a who's who in the solar-cooking movement
- Guidelines for designing your own cooker
- Plans for building the **SunStar** cooker with salvaged and inexpensive materials
- Tips and tricks for cooking with the sun

**With 200 Photographs & Diagrams**

Call Home Power Publishing

**\$15**

**800-707-6585**

S&H: \$5, Canada: \$6  
International: \$10

Outside USA 541-512-0201

Visa, MasterCard, Discover, & American Express

# Sorting Out the Alternatives:



## *EVs, Hybrids, & Fuel Cell Vehicles*

Shari Prange

©2003 Shari Prange

The Toyota RAV4-EV was the last pure electric vehicle commercially available to the public.

**R**emember the flying cars we were all supposed to have by now? Got yours yet? Me neither. Reality has fallen short of the predictions of yesteryear. Today's predictions include all kinds of alternative vehicles that are "just around the corner." Are these any more real than flying cars? Let's sort out the reality from the hype.

### **Reading Between the Lines**

First, we need to understand a little bit about press releases from auto manufacturers. There are five levels of reality in them. The least real is the "future technology" press release. These are projects the company is working on, and hoping to bring to fruition some time in the indefinite future. Maybe. A sure sign of this is a lack of any photo of an actual car.

The second level is the "concept car." These can be deceiving. You see a beautiful shiny car at an auto show or in a magazine, with a complete list of features. It's real, because you can see it, right? Wrong. This is a one-off car that a company builds just to demonstrate all the nifty things they could do. It bears no more resemblance to production cars than those bizarre outfits on fashion show runways resemble off-the-rack clothes.

The third level is the "prototype." This is similar to the concept car, but the manufacturer is seriously thinking about putting it into production. But it's not there yet. GM introduced the Impact prototype in 1990, but it didn't reach the public as the EV1 until 1995.

The fourth level is the "test vehicle." In this case, the manufacturer makes a limited number of vehicles and releases them under very limited and controlled conditions for some real world testing. In effect, the EV1 was killed after this stage, with only a few hundred leased, and those taken back to be crushed when the leases ran out. Often, test vehicles are not released to the public, although they may be available to corporate fleets.

The fifth level is "production." This is when you can actually go to your local dealer, sign the papers, hand over the money, and drive away in one of your very own.

Many people get excited about announcements of alternative vehicles because they mistake one of the first four levels for the fifth level. Keep these levels of reality in mind as we examine the various types of alternative vehicles. This article is meant to be an overview, not an in-depth profile of any technology or vehicle. For more details, see the references to earlier *HP* articles, and the Access information at the end of the article.

### **Electric Vehicles**

Electric vehicles (EVs) get their energy from electricity stored in batteries, which power an electric motor to



**The Honda Civic hybrid is one of the few alternatives that is actually for sale to the public today.**



**A hybrid system, like the one in the Honda Civic, is a complex combination of many components.**

drive the wheels. The batteries are recharged from an outside energy source when the car is parked.

The biggest selling point for EVs is their cleanliness. They have no tailpipe emissions at all. Even including emissions from the utility power plant, an EV is vastly cleaner than a gas car. If it is charged from clean sources such as solar or hydroelectric systems, it is truly a zero emission vehicle (ZEV). However, even EVs charged from dirty, coal-fired power plants are several times cleaner than gas cars.

The second biggest benefit to an EV is its lack of maintenance and repairs. An EV is much simpler than an internal combustion engine (ICE) car, so it has fewer parts. With only one moving part in the drive system (the motor shaft) and no combustion heat, there is almost nothing to wear out, and no tune-up or oil change is needed. The only maintenance, if the car has flooded-type batteries, is checking and topping off the battery fluid levels.

The next most obvious advantage is an EV's silence. A less obvious point is its energy efficiency. An EV is about 50 percent more efficient over the total energy cycle than a gas car. The amount of oil converted to gas that will

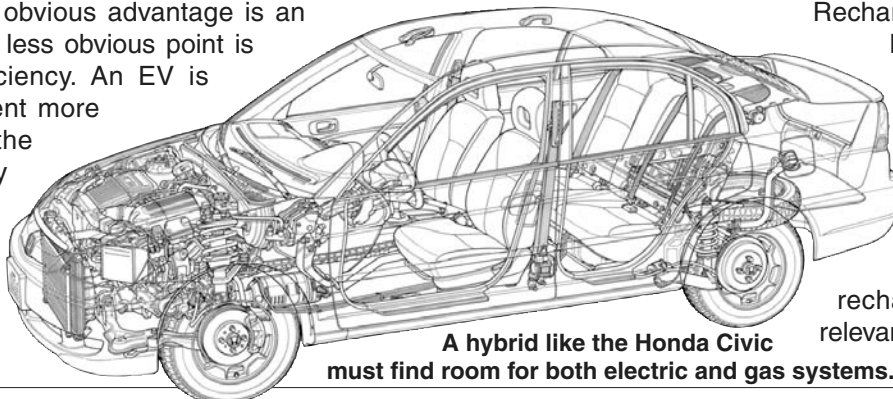

**A hybrid like the Honda Civic must find room for both electric and gas systems.**

drive an ICE car 100 miles will drive an EV about 150 miles miles if the oil is converted to electricity instead of gas. This takes into account all of the energy losses for both processes, from the oil well to the wheels.

Depending on gas and electricity prices, EVs sometimes show a savings in fuel costs. Even in the worst case comparisons, electricity costs for an EV are comparable to gas costs, not worse.

What are the disadvantages to an EV? Most people focus on the "limited" driving range before needing a "refill," and on the length of time needed to recharge. In many cases, these disadvantages are more a matter of perception than reality. Low-performing EVs may have a range of only 20 to 30 miles (32–48 km), but high performers, such as the RAV4 EV may get over 100 miles (160 km). Most conversions get 40 to 60 miles (65–95 km) range on average. The great majority of vehicles in America travel less than 25 miles (40 km) in a typical day.

Recharging can take up to 12 hours in worst cases, but may be only 4 to 5 hours in other situations. If recharging is done overnight, or during the workday, this is no handicap at all. The range and recharge issues are only relevant for high mileage daily



Several manufacturers, including Ford, have fuel cell vehicles in development, but not available yet.



A fuel cell vehicle, like this Ford Focus, involves special packaging challenges.

drivers, or for long distance traveling. For more details about EV pros and cons, see *HP84* and *HP91*.

In the early days of automobiles, EVs outnumbered gas cars. They faded with the advent of the electric starter for gas cars, which eliminated hand cranking. They enjoyed surges of interest during the gas crises of the early and late 1970s, when various small companies produced them, often as conversions of gas cars.

The EV idea was revived again by the Gulf War and the California Air Resources Board's (CARB) mandate for production of "zero emissions vehicles." The major manufacturers got involved. GM led the way with its EV1, and later, an electric Chevy S10 pickup. Honda followed close behind with the EV Plus. Ford offered an electric version of the Ranger pickup truck, and Toyota offered the RAV4 as an EV.

Only these vehicles actually made it into the hands of ordinary folks, however briefly. Many other EVs were loudly trumpeted with press releases from the future technology to test vehicle levels. Unfortunately, most were available by lease only, or only in very limited quantities and cities. The manufacturers and oil lobbies steadily pressured CARB until the mandate was watered down to a mild suggestion. EV production was curtailed, leases not renewed, and existing vehicles were taken back and sent to the crusher.

Today, no pure electric, full-function vehicles are available to the public from major manufacturers. The few that did make it into production have been discontinued, despite waiting lists of interested buyers.

There are a few small companies attempting to produce electric cars, with limited success. The only realistic options for the average person who wants to acquire an EV at this time are buying one used, or doing a home conversion, using a kit of drive system components. Probably as many electric conversions are on the road as there are production electrics, and maybe more.

### Hybrid Electric Vehicles

A hybrid electric vehicle (HEV) uses both gas and electricity to solve the limited range and long charging time issues of pure EVs. HEVs can be designed in different ways. In a series hybrid, the energy flows in a single straight line. Gasoline powers an engine, which turns a generator, which charges the batteries, which power an electric motor, which moves the car. The problem is that it takes a *lot* of energy going into the batteries to keep up with what the car is taking out of the batteries to drive. In fact, you can't completely eliminate the battery pack because the generator simply can't put out the energy needed for acceleration.

Another design is the parallel hybrid, in which both ICE and EV systems power the car. It can drive in pure electric mode, or pure gas mode, or both combined for extra power.

Auto manufacturers have joined these two design types in a complicated combination. The hybrids offered for sale operate sometimes in series mode, sometimes in parallel, and sometimes a little of both at once. An onboard computer constantly monitors the car's energy needs and the state of the batteries. It then chooses which system (or combination) will provide the power



the car needs, protect the battery pack from over-depletion, and do so most efficiently.

The main advantages of hybrids over pure electrics are extended range and quick refueling. The advantages over gas cars are better mileage and lower emissions. A secondary “advantage” is that, since they are powered by gasoline, no special new infrastructure is needed. This is a double-edged sword, however. It also means that these vehicles are still petroleum dependent. They *cannot* be plugged in to recharge with electricity from the utility or a renewable energy system.

Hybrids are much more complex than pure electrics or gas cars, so there are more possible ways for something to go wrong. Because they still involve a combustion engine, they require filter and fluid changes, and tune-ups.

Whether the balance of pros versus cons tips in favor of hybrids or against them will depend on your priorities, and whether you are comparing them to EVs or ICEs. To put it in RE terms, an HEV is like a grid-powered home with compact fluorescent lights and energy efficient appliances. An EV is like a home with an RE system.

For various reasons, not everyone can use an EV, or an RE system. The in-between solution—the hybrid car, or the energy efficient grid home—is a valid option, and certainly better than the old technology. Mass market hybrids are an excellent choice for many people, and would be even better if manufacturers made the electric component more significant, and offered the option of plug-in charging from clean sources.

One plus for hybrids over EVs is availability. Hybrids are in production and available at the consumer level, and more will become available in the near future. The first hybrids to hit the market were the four-seat Toyota Prius (see *HP83* and *HP85*) and the two-seat Honda Insight (see *HP82*). Honda has since expanded to include a hybrid version of the Civic.

GM has announced plans to begin offering hybrid drive systems on more than a dozen models. These will be available to fleets first. The first available to the public will be the GMC Sierra and Chevy Silverado pickups in 2004. Other models will be phased in during the following years.

A word of explanation is in order about the Sierra and Silverado, however. GM calls these “mild hybrids,” but this is a misnomer. They will have 42 volt electrical systems, which is not that remarkable. The gas car industry is moving toward 42 volts as the future standard to support all of the electronics now included in cars. (The so-called 42 volt system actually uses a 36

volt nominal battery, but it is called 42 volts because this is what it will operate at when the vehicle is running, just as the familiar 12 volt nominal car battery actually operates at 14 volts while you’re driving.)

The electrical system in these mild hybrids does nothing to move the vehicle down the road. It only supplies energy for accessories and computer controls. In this case, “accessories” includes power steering, which is electrically powered instead of belt driven, to reduce the load on the gas engine.

These trucks achieve improved emissions and mileage by using a computer system to shut down the engine at stops and restart it when the throttle is depressed. In short, these are not gas-electric hybrid drive trains. They are gas drive systems with an unusually large and complex array of electronic peripherals.

Chrysler will be releasing the Dodge Ram Contractor’s Special pickup truck by 2005. This is intended as a work truck for building contractors. It will feature a hybrid drive system, and an electrical panel on the side of the truck to allow it to serve as a low-cost generator at work sites.

All of these hybrids are primarily gas cars, with electric systems added to improve power, mileage, and emissions. Some, like the Honda, are not capable of driving under pure electric power at any time. Others, like the Toyota, run as pure electrics at low speeds. In all cases, the gas engine is the primary motive power.

All of the above comments have been in regard to HEVs built by major manufacturers. Although it is technically possible to do a home hybrid conversion, the results are not anywhere near as impressive (see *HP74*). This is due to the fact that suitable components simply aren’t available at the consumer level. Homebuilt hybrids tend to be noisy and vibrating, with little more range than a pure electric conversion, and often much more pollution than a standard ICE.

### Fuel Cell Vehicles

Vehicles powered by fuel cells are really a subset of EVs or hybrids, and they are often called fuel cell vehicles (FCVs) or fuel cell hybrid vehicles (FCHVs). In an FCV, energy is stored as hydrogen, rather than as electricity in batteries for an EV, or as gasoline for an ICE. The fuel cell is a device for extracting the energy from the hydrogen. The energy is then fed to an electric motor and drive system much like those in an EV. Like hybrids, FCVs also include a small battery pack for high power draw situations, such as acceleration.

FCVs provide the clean and quiet operation of EVs and the fast refueling of HEVs. However, the technology is not as simple, and fitting it into a vehicle is a special challenge. Part of the problem is that the hydrogen has

to be extracted from some other fuel, in a very pure form. Should the extraction be done on the car, or should it be done at a stationary location? Also, what fuel should the hydrogen be extracted from?

Both of these issues are still much under debate in the industry. Each option has its own advantages and drawbacks. Some pros and cons are technological issues, some are economic, and others are environmental. For a more in-depth discussion on the technology, see *HP76* and *HP77*.

Fuel cell technology is in the concept, prototype, and testing phases, depending on which manufacturer you look at. Industry estimates vary from a few years to a few decades for mass marketing of fuel cell vehicles. Chrysler announced their NECAR concept eight years ago. They are now entering the test vehicle stage. Ford also has a fuel cell vehicle, the FCV Focus, in testing, and is estimating it will be 2010 before they are commercially available. Honda's FCX, a fuel cell vehicle based on the platform of the discontinued EV Plus, is in the testing stage, but no date is given for mass production.

President Bush, in his State of the Union address on January 28, promised US\$1.2 billion dollars of funding for research into fuel cells as a cleaner alternative. Government support and subsidies have always been a great boon to the advancement of a technology. Although this may speed up fuel cell development, it is too soon to say how this will affect the availability timetable, or whether it will apply to consumers as well as to corporate fleets.

**Reality: What a Concept!**

We've looked at three electric-based personal transportation alternatives. Battery powered, pure electric cars are real from a technology point of view. They have been built and proven. Unfortunately, the manufacturers have pulled their support from the technology. EVs could be production vehicles, but aren't.

Hybrids are not as clean as pure electrics, but they are cleaner than conventional ICE cars, are available in the marketplace, and will be more available in the next few years. They are production vehicles.

Fuel cell cars are at the testing stage at best. They will probably require massive changes in infrastructure to provide hydrogen refueling stations.

They may not reach production for several years yet—or several decades, even with huge government incentives for research. When they do come true, they hold the potential to take EVs to a new level. As with hybrids, just how much improvement they represent will depend on the manufacturers' level of commitment to break away from dirty fuel sources, such as gasoline, to provide the necessary hydrogen.

**Access**

Shari Prange, Electro Automotive, PO Box 1113-HP, Felton, CA 95018 • 831-429-1989 • Fax: 831-429-1907  
shari.prange@homepower.com  
www.electroauto.com

American Honda Motor Co., Inc., Honda Automobile Customer Service, 1919 Torrance Blvd., Mail Stop: 500-2N-7D, Torrance, CA 90501 • 800-999-1009  
Fax: 310-783-3023 • www.hondacars.com

Toyota, 19001 S. Western Ave., Torrance, CA 90509  
800-468-6968 • www.toyota.com

Chevrolet, PO Box 33170, Detroit, MI 48232  
800-222-1020

GMC, PO Box 33172, Detroit, MI 48232  
800-462-8782

Chrysler, PO Box 21-8004, Auburn, MI 48321  
800-992-1997

Ford Motor Company, PO Box 6248, Dearborn, MI 48126 • 800-392-3673

Hybridcars.com • info@envirotoday.com  
www.hybridcars.com • Online magazine



**ZOMEWORKS**  
Passive Energy Products

Zomeworks has been a leading developer and manufacturer of passive energy products since 1969. Our innovative product lines include **photovoltaic mounting structures, temperature regulating enclosures and architectural sun control devices.**

**Introducing New Mounting Racks & Cool Cells!**

- Universal Track Racks™
- Newly Designed Fixed Racks
- PV Cool Cells™ and Battery Boxes

**ZOMEWORKS CORPORATION**  
Post Office Box 25805 (1011 Sawmill Rd. NW) Albuquerque, New Mexico 87125  
Website: www.zomeworks.com email: zomework@zomeworks.com  
[800] 279-6342 [505] 242-5354 phone [505] 243-5187 fax  
**Call us for a dealer near you!**  
© Zomeworks Corporation

**sunelec.com**

## NO-HASSLE WATER POWER

If you have a reasonably fast running stream or tide nearby and 12" of water clear, Aquair UW Submersible Generator can produce 60 to 100 Watts *continuously*, up to 2.4 KWH per day. **NO TURBINES, NO DAMS, NO PIPES!** Water speed 5 mph (brisk walk) = 60W. 8 mph (slow jog) = 100W. Timber, rock, or natural venturi increases output.

**Jack Rabbit Energy Systems**

425 Fairfield Ave.,  
Stamford, CT 06902  
(203) 961-8133  
FAX (203) 961-0382  
e-mail: jackrabbitenergy@worldnet.att.net



*Survival Unlimited.com*

**Emergency Preparedness  
& Survival Supplies**

**600 WATTS OF WIND POWER  
\$329.00 & UP**

## Solar Products

Water Filters, Composting Toilets, Radios, Flashlights, Petromax Lanterns, Dietz, Aladdin Lamps, Camping Stoves, PulseTech Desulfators, Batteries, Bergy Wind Turbines, CF Bulbs, Trace, Xantrex, Outback, Mountain House Foods, AlpineAire Foods, Food Storage Supplies, Potassium Iodate Nuclear Protection, Appliances, Water Storage, Hand/Solar Water Pumps, Clothes Wringers, First Aid, Fuel Storage, Generators

**Great Prices, Really Great Products!**

235 N. Airline Hwy, Gonzales La. 70737, Sorry No Catalog,  
1-800-455-2201 SURVIVALUNLIMITED.COM

**hupsolarone.com**

**There Is A Difference!**

# solar 7

## HOME POWER on CD-ROM

**Original Magazine Layouts & More**

Color • Indexed • Searchable • Exportable • Printable

Adobe Acrobat PDF<sup>®</sup> format (reader included)

**Issues #83 (June '01) through #88 (May '02)**

Over 5,000 pages of renewable energy information: spreadsheets for load analysis, wire sizing, and the Energy Master for system design; classic basic articles from the *HP* archives; 30 years of solar insolation data & wind data for 900 sites in the U.S.; manuals and spec sheets of popular RE equipment; the *current* InBiz database; and a searchable index. Bonus video clips in QuickTime video format

Home Power, PO Box 520, Ashland, OR 97520  
800-707-6585 • 541-512-0201 • fax 541-512-0343 • www.homepower.com

*SunWorld*, the official magazine of the International Solar Energy Society says, "Together these CDs offer the largest collection of useful and practical information on achieving energy independence ever available."



**\$29**

**Shipping: \$2 in US**  
(Canada \$3; International \$4)



**LOWEST PRICES UNDER THE SUN!**

**1.800.329.3283**

**www.earthsolar.com • contact@earthsolar.com**

**Call For Special Pricing On The New *OutBack* Power Systems Products!**

**SOLAR PANEL SALE!**

**SHARP**

Sharp 175W, 24V  
1 for \$675, 2 for \$655ea,  
4 for \$645ea, 10 for \$635ea

Sharp 165W, 24V  
1 for \$638, 2 for \$618ea,  
4 for \$608ea, 10 for \$598ea

Sharp 123W, 12V  
1 for \$479, 2 for \$469ea,  
4 for \$459ea, 10 for \$444ea

**SHELL /SIEMENS  
SP75, 12V**

1 for \$303, 2 for \$293ea,  
4 for \$283ea, 10 for \$273ea

**SP140, 24V**

1 for \$538, 2 for \$528ea,  
4 for \$608ea, 10 for \$598ea



**KC120**

120 Watts

**\$469**

OR  
2 for \$459ea, 4 for \$449ea,  
10 for \$434ea

**KC80, 80W - \$365**



**SX75, 75W**

1 for \$313, 2 for \$303ea,  
4 for \$293ea, 10 for \$283ea

**2150S, 150W**

1 for \$574, 2 for \$564ea,  
4 for \$554ea, 10 for \$544ea



**Prosine  
2.5Kw**

True Sine Wave Inverters  
12 Volt - \$1,876  
24 Volt - \$2,028

**INVERTERS**

- |                      |                             |
|----------------------|-----------------------------|
| Notepower 75 - \$61  | Prosine 1000 GFCI - \$627   |
| Prowatt 150 - \$62   | Prosine 1000 - \$660        |
| Prowatt 250 - \$90   | Prosine 1800 GFCI - \$916   |
| Prowatt 800 - \$371  | Prosine 1800 - \$948        |
| Prowatt 1500 - \$532 | Prosine 3.0Kw 12V - \$2,199 |
| Prowatt 2500 - \$815 | Prosine 3.0Kw 24V - \$2,355 |

**WIND GENERATORS**

**AIR 403**  
• 12, 24, 48 Volt  
**AIR** wind module • \$464

**H-40 Turbines**  
**900W (180Kw mo. @ 15 mph avg)**  
• EZ Wire II Wind Controller  
• 24, 36 or 48 Volt  
**\$1,199**  
• EZ Wire I Wind/PV Controller  
• 12, 24, 32, or 48 Volt  
**\$1,447**

**H-80 Turbines**  
**1000W (300Kw mo. @ 15 mph avg)**  
• EZ Wire II Wind Controller  
• 24, 36 or 48 Volt  
**\$1,608**  
• EZ Wire I Wind/PV Controller  
• 12, 24, 32, or 48 Volt  
**\$1,907**

**Southwest Windpower**  
*Renewable Energy Made Simple*

**AIR X** *New!*  
• 12, 24 Volt  
• \$499

**WHISPER H-175 Turbines**  
STARTING AT: **\$4,398**  
"The Most Powerful Turbine of the Lineup!"

**3000W (820Kw mo. @ 15 mph avg)**  
• EZ Wire I Wind/PV Controller  
• 24, 32 or 48 Volt  
**\$4,398**  
• EZ Wire I Wind/PV Controller  
• 220 Volt  
**\$5,906**

**WATER PUMPS**

Call Us About **Dankoff ETAPUMPS®**

**SC Series**  
Price Range:  
**\$1,460 to \$1,794**

**SD Series**



Price Range: **\$725 to \$967**  
Controllers: **CC 2000 - \$450 CD 300 - \$449**

**CHARGE CONTROLLERS**



- |                  |                   |
|------------------|-------------------|
| PS-15 - \$98     | SL-20-24V - \$123 |
| PS-15M - \$145   | SS-6 - \$45       |
| PS-30 - \$129    | SS-6L - \$55      |
| PS-30M - \$181   | SS-10 - \$55      |
| SG4 - \$31.28    | SS-10L - \$65     |
| SL-10 - \$89     | SS-10-24V - \$59  |
| SL-10-24V - \$95 | SS-20L - \$83     |
| SL-20 - \$121    | SS-20L-24V - \$87 |

**SOLAR BATTERIES**

*New!* **Rolls-Surrette**  
Solar Deep-Cycle Batteries  
FREE Freight on Quantity Orders!  
CALL FOR DETAILS.

- Model S-530 - \$199**  
**Model S-460 - \$155**  
• 530 AH (100 hr rate)  
• 460 AH (100 hr rate)  
• 12.25" x 7.125" x 16.75"

**Dealer Inquiries WELCOME!**

**Sunny Boy INVERTERS**

*New!* **SB1800!**  
W/ or W/O Display



- 1800 (W/O Display) - \$1,576  
1800D (W/ Display) - \$1,677  
2500 (W/O Display) - \$1,909  
2500D (W/ Display) - \$2,011



ProStar \$98 - \$180.33



SunSaver \$45 - \$87



SunLight \$89 - \$123

# Power From The People



A Video Documentary  
by John Schmit

*"Guerrilla solar  
on the big screen—  
far freakin' out!"*

—Richard Perez  
Home Power Magazine

43 min, VHS: \$19.95 plus shipping

Breaking Barriers to Renewable Energy Distribution

To order, contact **Home Power**

800-707-6585 • 541-512-0201 • [www.homepower.com](http://www.homepower.com)

PO Box 520, Ashland, OR 97520

## Energy Systems & Design Ltd.

Microhydro systems since 1980

Manufacturer of the Stream Engine

We offer turbines for low, medium and high flows and heads, components and tech support. *Dealers Welcome!*

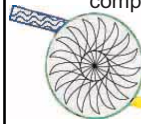

**NEW!** Solar LED (white) mini flashlights: \$25.00!

Ph: 506-433-3151

Fax: 506-433-6151

[www.microhydropower.com](http://www.microhydropower.com)

DESIGN — SALES — INSTALLATION

## EV Solar Products

2655 N. Highway 89  
Chino Valley, AZ 86323  
tel: 928-636-2201  
fax: 928-636-1664  
[www.evsolar.com](http://www.evsolar.com)

Solar Electric Systems  
Wind Generators

Solar Hot Water  
Green Building Products

Energy Efficient Products

Back-Up Power Systems

Solar Energy Solutions Since 1991

# ZAPSUCKER .COM



## A Good Deal for our readers!

Buy a subscription (\$22.50)  
get Solar1 cd-rom for only  
\$19 (regularly \$29).

Hey—that's a  
really good deal!

To order, get ahold  
of Home Power—

800-707-6585  
541-512-0201

[www.homepower.com](http://www.homepower.com)

PO Box 520,  
Ashland OR 97520



Renewable Energy  
Basics



Independent Energy Systems

*Our 19th Year Offgrid!*

*We provide excellent service & technical support.*

Residential Power • Water Systems • Communications  
Wind • PV • Hydro • Custom Design • Installation  
All Major Brands • Mail Order Catalog Available



## OFF LINE

Located in the central Sierra, near Yosemite

e-mail: [ofln@aol.com](mailto:ofln@aol.com)

[www.psnw.com/~ofln](http://www.psnw.com/~ofln)

P.O. Box 231, North Fork, CA 93643

(559) 877-7080

CA Lic. #661052

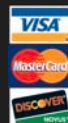

KYOCERA  
KYOCERA SOLAR, INC.





## Owner's Guide to a Used EV— Part 2

Mike Brown

©2003 Mike Brown

In the last issue, I wrote about getting to know your newly purchased, used, conversion EV. I talked about studying the documentation, and the importance of keeping a trip logbook as a means of keeping track of the condition of the batteries and the other systems in the EV. Then I took a look at battery and battery cable maintenance. In this article, I'll discuss charging the batteries, mechanical maintenance, and how to drive an EV efficiently.

### Filling the "Tank"

Before you start charging your EV's battery pack, you should review the operating instructions for the charger that came with the car or truck. If you didn't get a manual for the charger, you should refer to the notes you took when the previous owner described the charging process.

These notes are most important if the charger is a homebuilt unit instead of a charger built by a commercial company. These chargers, for the most part, are not as sophisticated as a factory-built charger, and could damage your new battery pack. My advice is to use any homebuilt device very carefully until you can replace it with a professionally built charger.

Most conversions have onboard chargers wired to the battery pack. If yours doesn't, start the charging process by connecting the charger to the pack, with the charger turned off.

Since most conversions charge on ordinary 120 VAC, is plugging the cord from the charger into an outlet the next step? Not quite. Check the circuit breaker for the outlet. It should be at least a 15 amp breaker. A 20 amp

breaker is better, since AC amps in has a direct relationship to DC amps out.

To avoid overloading the breaker and causing a nuisance trip, your charging circuit should not have any other devices plugged into it. Any charging outlet that is exposed to the weather should be equipped with a ground fault interrupter.

The last thing to check is the extension cord between the wall outlet and the EV. Most charger manufacturers specify a cord made with #12 wire no more than 25 feet (7.6 m) long. The use of smaller gauge wire or a longer cord could lead to a dangerous amount of resistance and a melted or burnt cord. With the charger plugged in and running, follow the manufacturer's instructions to adjust the charger to suit your AC current source and DC amperage and voltage requirements.

The finish voltage of the charger should be checked from time to time. If it is too low, you won't get a full charge. This is more critical if your charger uses the finish voltage as a signal to turn the charger off completely, as opposed to leaving it running at low amperage until you unplug it.

If the finish voltage is set too high, there is a risk of battery damage from overcharging and excessive gassing, which will result in the need for more frequent battery watering and cleaning. Check the finish voltage by taking a battery pack voltage reading near the end of the charging cycle with the charger running. A flooded lead-acid battery is fully charged at a voltage of 2.5 volts per cell with standard EV charging rates. To find your finish voltage, multiply 2.5 volts times the number of cells per battery, times the number of batteries in the battery pack.

For example, the finish voltage of a 96 volt pack of 6 volt batteries is worked out like this: 2.5 volts x 3 cells per battery = 7.5 volts; 7.5 volts x 16 batteries in the pack = 120 volts. The finish voltage setting of the charger will need to be reset at least twice—once as a new battery pack breaks in to reach its full capacity, and then as its capacity declines with aging.

It is very important to charge the batteries at the end of any day that the EV has been driven, no matter how short the trip was. If your conversion has a total range of 60 miles, but it only goes 10 miles a day, don't wait six days to charge it. Not charging daily will result in decreasing range and possible battery damage. Lead-acid batteries don't like to sit partially discharged, and will lose capacity if they are treated this way.

A modern, commercially built charger won't overcharge a pack that has only been slightly discharged. However, if your charger is the type that tapers down to a low

constant amperage but keeps running, find out how long it takes to reach finish voltage from the pack's partially discharged level. If it only takes a couple of hours to get to the finished point, shut it off after that length of time. There is no point in wasting electricity and gassing the batteries unnecessarily.

If the EV is going to be unused for an extended period of time, such as a vacation, fully charge the pack before you go and leave it unplugged while you are gone. When you get back, drive the car a short distance to "wake up" the batteries, and run it through the charge cycle.

### **Maintenance: What's Left to Do?**

When you get rid of the gas or diesel engine along with the cooling, exhaust, and fuel systems, you also take away most of the maintenance that is required by a car or truck. The necessary battery cleaning and watering is performed more frequently than, say, an oil change or tune-up. However, this maintenance service is something the EV owner can easily do, and materials used are significantly less expensive.

This doesn't mean that battery service is all the maintenance you have to do. Again, while most of these tasks are things the EV owners can do themselves, eliminating expensive shop labor costs, it is still very important that they be done to ensure safe and efficient operation of your conversion.

### **Tire Inflation & Wear**

First on the list is keeping the tires properly inflated. An accurate tire gauge is the only tool needed. Finding a source of compressed air, in these days of self-serve gas stations, might be the hardest part of the job. Proper tire pressure has a direct effect on range because a tire with low air pressure has higher rolling resistance than a correctly inflated tire. High rolling resistance means more current draw on the batteries, and therefore, lower range.

Tire pressure also is an important factor in the load carrying ability of a tire. Since you are carrying more weight due to the battery pack, keeping the tires properly inflated is very important for safe operation of your EV. The tires on a conversion EV should be inflated to at least the maximum pressure printed on the sidewall of the tire. A conversation with the previous owner or a knowledgeable tire salesperson might help you arrive at the right tire pressure for your vehicle.

Since you are getting up close and personal with the tires when you are checking their pressure, you can perform another maintenance task—checking how the tread is wearing. That can tell you several things about the tires and the vehicle they are installed on. For

example, if both outside edges of the tread are worn more than the center, the tire has probably been underinflated. If the opposite is true, and the center is worn the most, the tire has been run overinflated.

If the inside edges of both front or both rear tires are worn, the wheel alignment is considered to have too much "toe out." Conversely, if the outside edges are worn, the wheels are said to have too much "toe in." Either condition causes additional rolling resistance and shorter range. While you can correct the tire pressure problem and detect the wheel alignment problem, correcting the alignment requires specialized equipment and knowledge.

### **Making Sure It Will Stop**

The condition of the brake system is an important part of an EV owner's maintenance routine. Due to the additional weight of the batteries, the brakes may wear faster than they did before the car or truck was converted.

If the EV was running before you bought it, you should have had the brake system checked as part of your prepurchase inspection. Ask the owner when the brake system was last worked on, and what was done at that time. Try to get the mileage the car had on it when the work was done, or at least the month and year. This will establish an approximate lifespan of the brake pads or shoes.

If you are starting with a fresh brake job, cut the recommended brake lifetime mileage, or time in service, in half to determine when to inspect your brakes. An EV weighs more after the conversion, so brakes will likely wear faster and should be inspected more often. Your driving conditions and style will also make a difference in brake wear. If you are going with brakes that were not brand new but were still considered good at the time of inspection, cut the number of miles or months in half again. Add the miles to the EV's present mileage or note on a calendar the appropriate number of months in the future. When the number of miles or months has elapsed, check the brakes again and note the amount of wear.

After a couple of these periodic checks, you will have established your own brake wear profile, and can adjust the brake check intervals accordingly. The brake check should include how the pads and/or shoes are wearing. This is important for more than just knowing when to replace them. If they are wearing unevenly, this will tip you off to sticking calipers, hand brake cable problems, or poor alignment. All of these things can cost you range. You should also check for leaking brake fluid and poorly adjusted brake calipers.

## Calculating Red Line

Like any motor or engine, an EV motor will self-destruct if driven faster than it was designed to run. Since most conversion EVs don't have tachometers to tell us what rpm the motor is turning, we need to know the top speed (in mph) in each gear. Once you know that speed for each gear of the transmission, the EV should not be driven, coasted, or towed faster than those speeds.

Use the following formula to calculate the top speed in each gear:

$$\text{mph} = (\text{rpm} \times R) \div (G1 \times G2 \times 168)$$

Where:

mph = maximum speed for the gear specified by G1

rpm = top rated motor rpm (red line)

R = rolling radius of drive wheel tire in inches

G1 = gear ratio for specific gear

G2 = final drive ratio

168 = constant

Note: the gear ratio for each gear and the final ratio can be found in your factory service manual.

Here is an example using a VW Bug in first gear and a motor red line of 5,000 rpm.

$$\text{mph} = (5,000 \times 12) \div (3.8 \times 4.375 \times 168)$$

$$\text{mph} = (60,000) \div (2,793)$$

$$\text{mph} = 21.48$$

Be sure to check for worn wheel bearings. A bad wheel bearing can increase rolling resistance, and can cause expensive damage if it seizes. One benefit of the EV's quiet operation is that, while driving, you will hear a bad wheel bearing long before you would hear it over a conventional car's noise.

If the brake check described above sounds beyond your abilities or tools, find a dealership service department or an independent repair shop that handles the make of vehicle that your conversion was based on, and have them do the brake inspection at the required mileage intervals. *Don't neglect this vital part of EV ownership!*

### On the Road at Last

I recommend that a new conversion owner start his or her EV driving experience with a few short trips around the neighborhood. These small trips allow you to get a feel for the conversion's acceleration, braking, and handling without the stress of having to be at work at 8 AM.

One thing you want to get a feel for is when to shift gears. The electric motor in a conversion EV is most efficient at high motor rpm (revolutions per minute), so you want to select a gear that allows you to travel at your desired speed while drawing the lowest current. At the same time, you don't want to run the motor over its rpm limit when driving. You also don't want to coast down a hill in too low a gear at too high a road speed. Either way, overspeeding the electric motor will damage it beyond repair. To help you find out what the safe speed is for each gear, use the equation in the sidebar.

Coasting is a unique feature of a conversion EV. When you let off the accelerator pedal of an EV, it doesn't immediately slow down due to engine drag like it did when it was gas or diesel powered. When an EV's pedal is lifted, all electrical energy stops flowing, the motor freewheels, and the vehicle coasts, slowed only by air and rolling resistance.

What this means is that you don't have to burn fuel to drive the car to the stoplight and then throw that energy away by using the brakes to stop. If you are driving an EV and see a stoplight ahead of you turn red, you let off the accelerator pedal and the car starts to coast. Depending on traffic, you might coast to the light, slowing gradually, and if it is still red, apply the brakes and stop. If the light turns green before you get to it, you press the accelerator down again and, since the motor is still turning at road speed, it takes only a small amount of energy to get back up to traffic speed.

After a few neighborhood trips, if a workday commute is the EV's main mission, make the first trip on a Sunday when there is less traffic. This lets you find that steep hill that would slow you to a speed that would be unacceptable to your fellow commuters during the rush hour.

Also, driving the conversion's required trip both ways without a chance for the batteries to rest for eight hours while you are at work is a good way to simulate your commute on a bad traffic day. That experience might indicate a need to charge at work to give you a safety margin on those bad days.

Planning a route to avoid amp-hour-draining hills or miles of stop-and-go driving pays off. Even if a trip is a little longer, driving that distance over flatter roads in smoother traffic can make a big difference in your state of mind as well as your batteries' state of charge.

### Happy Motoring!

In these two articles, I have tried to help the new owner of a used conversion EV make the transition to owning and driving electric. For more driving tips, see the articles by Shari Prange in *HP79* and *HP80*.



If you have any other questions, either general information or specific problems, feel free to contact me. Thanks for your interest and questions.

**Access**

Mike Brown, Electro Automotive, PO Box 1113-HP, Felton, CA 95018 • 831-429-1989 • Fax: 831-429-1907  
mike.brown@homepower.com • www.electroauto.com

Electric Auto Association, 2 Smith Ct., Alameda, CA 94502 • 510-864-0662 • contact@eaaev.org  
www.eaaev.org



**Photovoltaics**  
**Solar Heating**  
**Pool Heating**  
**New, used**  
**and Rebuilt**

**AAA Solar Supply**

**aaasolar.com**  
**800-245-0311**

**Systems and parts for the do it yourselfer since 1979**

**Do You Need Batteries?...**

**RAE Storage Battery Company**

*Since 1943... Quality & Service*

**Surrette Solar 1, 400 Series, Type CH 375 - L16**

Engineered under careful guidelines by Dave Surrette - Family owned business Est. 1935

**Dyno Batteries**

Custom Built Superior Deep Cycle Batteries from M. Knowlton family Since 1933. Seattle, Washington

**If you need Competitive Pricing & Prompt Delivery call: 860-828-6007**



Fax 860-828-4540  
51 Deming Rd., POB 8005,  
Berlin, CT 06037



**BZ Products Model MPPT 200**

**200 Watt, 16 Amp**

**MAXIMUM POWER POINT TRACKING CHARGE CONTROLLER**

- Boost charge current up to 30%  
15% boost typical
- 16 amps output current
- High efficiency 95%
- 10 amp low voltage disconnect
- LED battery gauge
- Optional lighting controller
- PWM control with temperature compensation and internal fuses
- Surface or wall mount
- Five year warranty
- Reliable
- Available world wide
- Patent pending

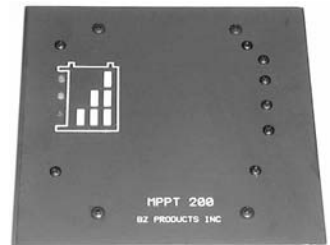

**BZ Products, Inc.**

314-644-2490 • bzp@brick.net  
7614 Marion Ct., St. Louis, MO 63143, USA

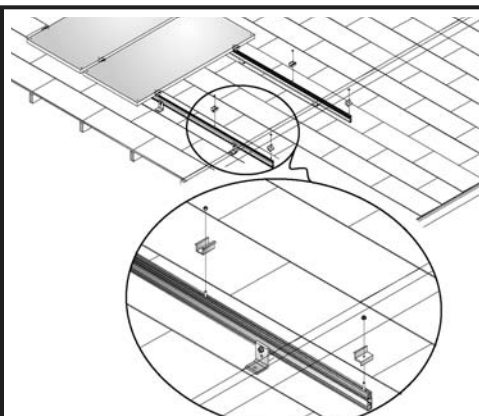

**SOLARMOUNT™**

Mount your modules on the roof ... or pre-assemble on the ground. The choice is yours with SolarMount — the fastest, easiest, and safest way to install your PV array in any location.

Explore the possibilities at **www.unirac.com**

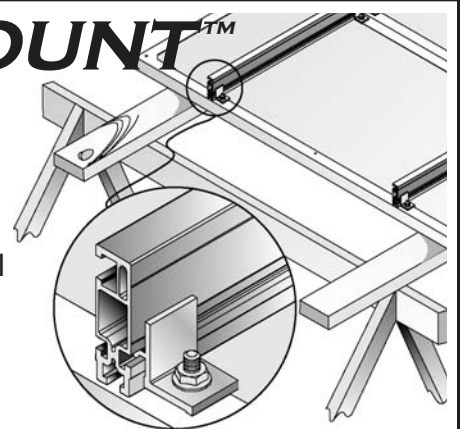

**THE NEW STANDARD IN PV MODULE RACKS™**

UniRac, Inc., 3201 University Boulevard SE, Suite 110, Albuquerque NM 87106-5635 USA  
Phone 505.242.6411 • Fax 505.242.6412 • info@unirac.com



**Bargains on Solar, Wind, Hydro,**  
Diesel Generators, Gas & Diesel Fuel Savers,  
Candles, Books, Staber Clothes Washer,  
Water Filters, Grain Mills, Water Pumps,  
Lights, Fans, Motors, Inverters, Solar Cookers,  
Bed Warmers, Telescopes,  
Composting Toilets & more!

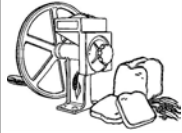

**PROPANE—**  
Refrigerators, Freezers, Ranges,  
Heaters, Lights.

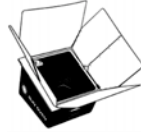

**Save up to 75%**

AM, FM & Shortwave Radios &  
Lights use famous wind-up spring  
motor/generator.  
No battery worries!



**\$4 Energy Catalog** has all the above and more.

**\$3 Food Catalog** everyday, camping & long term storage.

**\$5 Water Windmill & Hand Pump Catalog**

**Kansas Wind Power** HP3

~ Since 1975 ~

13569 214th Road, Holton, KS 66436 • 785-364-4407

**AUTOMAGIC BATTERY WATERING**

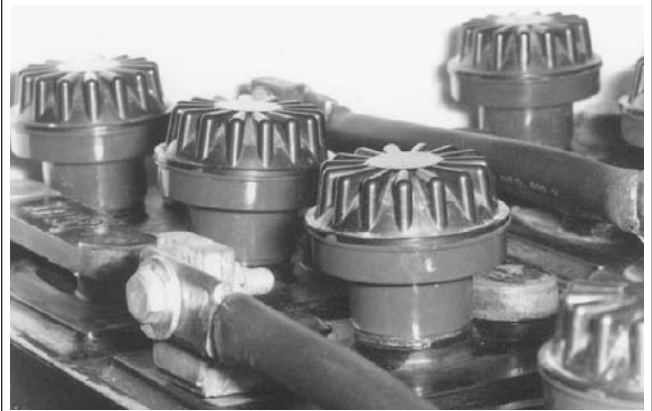

**WE MAKE WATER FROM YOUR GAS**

Hydrogen and oxygen battery gas catalytically recombined into pure water and returned to each battery cell. Keeps battery topped off for extended periods of time and reduces maintenance costs. Explosive hydrogen gas is virtually eliminated from the battery area. Corrosive spray and fumes are contained and washed back into each battery cell. Electrolyte kept strong longer, extending the useful power and life of the battery. HYDROCAP Vents simply replace the battery's caps. Battery maintenance is greatly reduced. Write or call for more information.



Things that Work!

**Hydrocap**  
CATALYST BATTERY CAPS

305-696-2504  
975 NW 95 St.  
Miami, FL 33150

**From the Fryer  
to the Fuel Tank**

The Complete Guide to  
Using Vegetable Oil  
as an Alternative Fuel



Joshua Tickell

Fuel *any* Diesel vehicle,  
generator, or engine with  
vegetable oil!

Complete instructions,  
photos, diagrams, parts  
lists, and resources for:

- Running a diesel on ***Straight Vegetable Oil***
- Making Biodiesel from Used Cooking Oil
- Building a Small Scale Biodiesel Processor
- Growing Oilseed Crops
- Diesel Vehicles

**NEW!**

**The Veggie Fuel Video...**

Follow Joshua Tickell as he makes biodiesel from used cooking oil with easy-to-read, onscreen instructions.

Book or Video \$29.95ea. (Outside USA add \$5)  
Book & Video Combo \$46.95 (Outside USA add \$7)  
1-800-266-5564 or 419-281-1802 (24 hrs/day)  
<http://www.veggievan.org/book.html>  
U.S. check or money order payable to:  
BookMasters, P.O. Box 388, Ashland, OH 44805

**NEW ENGLAND  
SOLAR ELECTRIC, INC.**

401 Huntington Road, PO Box 435  
Worthington, MA 01098  
1-800-914-4131



**\$16.95 plus \$3 PPS**  
(includes our \$3 catalog)

This is the most popular book for PV remote homes. It is written and published by New England Solar Electric Inc.

"Best all around book on wiring your PV system."

Real Goods Sourcebook

"Our favorite book for Do-It-Yourselfers."

Windy Dankoff, Dankoff Solar Products

"This should become the bible for alternative energy users."

Ken Cox, Trace Inverters

**Send \$3 for our 80 page catalog and product guide**  
Serval/Dometic Gas Refrigerators. Trace Inverters. Trojan Batteries.  
Siemens & Solarex PV modules, Osram Bulbs. Thinlite Fixtures  
AquaStar Hot Water Heaters. AIR 403 Wind Generators

**Best book, most user friendly catalog,  
& best kits in the business.**

## HYDROSCREEN CO. LLC

- Self Cleaning • Easy Installation • High Capacity
- No moving parts • Pipe, ramp and box mountings

- We specialize in creatively engineered solutions for your unique hydro diversion screening needs.
- Our solutions are cost effective with numerous screen mounting options; we also have durable bolt-together 304 SS mounting boxes.

Visit us at [www.hydroscreen.com](http://www.hydroscreen.com) or call (303) 333-6071

e-mail: [RKWEIR@AOL.COM](mailto:RKWEIR@AOL.COM)

Mention this ad for special savings!

## Precision Wedge Wire Coanda Screens

for Hydro, Agricultural, and  
Domestic Diversions from  
10 gpm to 500 cfs



## GreaseBaron.com

Vegetable oil fuel systems for diesel engines.  
Specializing in generator and stationary applications.  
Preheaters, filters, cooling drums, cold weather kits.

Control your own fuel supply!

W3883 Highline, Bonduel WI 54107



[www.sunelco.com](http://www.sunelco.com) • 800-338-6844

## ELECTRIC VEHICLE

COMPONENTS, CONVERSION KITS, PUBLICATIONS, VIDEOS,  
AND ENGINEERING DESIGN SERVICES FOR THE EV  
HOBBYIST AND MANUFACTURER...All components selected with  
safety and reliability foremost in mind....We stock and sell the  
largest variety of the very best:

- ◆ ADVANCED DC Motors in 12 variations from 2 HP to 28.5 HP
- ◆ CURTIS-PMC Controllers, Throttle Potboxes, Footpedals
- ◆ ALBRIGHT & KILOVAC Main & Reverse Contactors in 6 models
- ◆ GENERAL ELECTRIC & HEINEMANN Circuit Breakers
- ◆ BUSSMAN Safety Fuses from 200 to 800 amps
- ◆ DC-DC Converters from 48 to 336 V input
- ◆ K & W ENG. & BYCAN Battery Chargers from 48 to 144 V
- ◆ Full line of CURTIS, WESTBERG, & KTA Meters & Gauges
- ◆ DELTEC Meter Shunts from 50 to 1,000 A
- ◆ EVCC Adapter Plates, Couplings, Clamps, & Brackets
- ◆ PRESTOFLEX Welding Cable, MAGNA Lugs, Assy. Tools
- ◆ CONVERSION KITS for vehicles from 300 to 10,000 lbs.
- ◆ Complete ELECTRATHON Drive & Instrumentation Pkg.
- ◆ 4 Complete GO KART kits...for up to 90 mph..

## KTA SERVICES INC.

COMPONENTS & PUBLICATIONS CATALOG.....\$5.00  
Electric Vehicle components and systems since 1984

944 West 21st Street – Upland, CA 91784 USA

Tel: (909) 949-7914 – FAX: (909) 949-7916

Web: [www.kta-ev.com](http://www.kta-ev.com)



## Digital Power Meters

**20-CTR:** Measures  
AC Power up to 8 kW,  
100-250 vac single or  
two phase. Remote  
display. Easy to install.

**ONE Meter:** Semi-custom power meter. Up to 9 independent AC  
or DC power channels. Several display options. Can be  
configured for Whole House power monitoring. PC interface,  
8000+ data memory.

**4-1850WX:** Special meter for Refrigerator Replacement  
Programs. Detects Defrost Cycle, displays cost/kWh-hrs per  
year.

Other Models available. Check our website or call for details.

**CUSTOM APPLICATIONS and DISPLAY OPTIONS:**  
We can build a digital power meter to meet your needs,  
including large displays. Perfect for trade shows, public  
buildings and educational purposes. Several signs to  
choose from including the popular Beta Brite scrolling  
LED sign. Please call with your needs/ideas.

Brand Electronics  
421 Hilton Rd.  
Whitefield, ME 04353  
For information only, call 207-549-3401  
[info@brandelectronics.com](mailto:info@brandelectronics.com)

To order, call toll free  
**1-888-433-6600**  
[www.brandelectronics.com](http://www.brandelectronics.com)

# Planning a Code-Compliant, Off-Grid PV System

John Wiles

Sponsored by the Photovoltaic Systems Assistance Center,  
Sandia National Laboratories

**T**his *Code Corner* presents the planning and design overview for a photovoltaic (PV) system to supply the electrical needs for a new off-grid home. The electrical design is based on the requirements of the *National Electrical Code (NEC)*.

Local electrical codes may impose other requirements, and building codes may pose additional requirements on the mechanical installation. The numbers used and the results are very system specific and should not be used in the design of any other particular PV system.

## The House

Judy LaPointe, the homeowner, is retired and looks forward to living in an energy efficient house, powered by the sun and a little propane. The PV system will provide electricity for her 1,800 square foot (167 m<sup>2</sup>) residence in New Mexico, located about 0.5 miles (0.8 km) from the utility grid. The house is at an elevation of 4,500 feet (1,370 m) above sea level, and the design temperature range is from 10°F to 104°F (-12°C to 40°C). The record low temperature is -20°F (-29°C).

Wells in the area are at least 800 feet (245 m) deep, and two out of three drilled wells do not hit water. Because of the possibility of a dry well and the electricity requirements to pump water from 800 feet (245 m), Judy decided to have potable water for the house delivered by truck and stored in a 2,500 gallon (9,460 l) aboveground tank.

The home is being built with Perform Wall insulated concrete forms and has an R-50 insulated ceiling. A swamp cooler (evaporative cooler) will be used for summer air conditioning and an in-floor radiant heating system will heat the house during the winter months. A solar hot water collector, backed up by the propane-fired boiler, will provide potable hot water and radiant floor heating.

## Loads

See the load table for a detailed list of electrical loads planned for the system. The refrigerator, generally one of the largest loads in an off-grid system, is a 26 cubic foot (0.74 m<sup>3</sup>) model that uses a third to half the energy

of popular, inexpensive models. The controls and circulating pumps for the radiant heat boiler will be DC, and the system will be used only in winter. The swamp cooler will likely be the largest energy load because, even on slow speed, Judy may want to run it day and night for several months in the summer.

Electrical loads that have a continuous draw when turned “off” are connected to switched outlets or power strips to reduce phantom loads. These devices include the satellite receivers and the washing machine. Devices that draw 1 watt or less and have useful functions that need to be powered continuously will be left connected. They include the smoke alarms, microwave oven clock, two clock radios, cell phone recharger, and the TVs (channel memory).

## System Size

In addition to anticipated loads, an established upper budget limit and the cost of bringing underground utility service to the area were determining factors for the size of the PV system and related equipment. The initial quote for overhead utility lines was more than US\$35,000. The overhead lines were unacceptable to Judy, since they spoiled the magnificent views of the surrounding mountains and represented a “business as usual” use of nonrenewable energy. Underground utility lines would have cost significantly more due to the rocky terrain.

Southern New Mexico has an annual daily average of 6.5 hours of peak sun, and the few cloudy periods do not usually last more than three days. Load management during these cloudy periods and the use of the backup, propane-fired generator were entered into the system design process. Four other off-grid systems in the area were examined to provide additional information on system sizing.

The final system design has a PV array rated at 3,300 watts, DC at standard test conditions (STC)—1,000 watts per m<sup>2</sup> irradiance and 25°C (77°F) module temperature. The array consists of twenty, 165 watt, 24 volt PV modules.

## System Planning

After reviewing all of the loads and the various other constraints, a list of equipment required to complete the installation was compiled. Numerous calculations (explained in previous *Code Corners*—see the table on

page 108) were made to determine the rating of each piece of equipment for code compliance. Equipment was selected for extended durability and reliability over the expected 30 to 40 year life of the system. Of course, budget constraints prevented the use of gold-plated fixtures, and for the most part, commercially available hardware and electrical components were used.

Two 60 amp, maximum power point tracking charge controllers will maximize the PV array output in hot summer conditions and charge a 24 volt battery bank. The voltage drop due to the long circuit distance and the high summer temperatures resulted in the decision to

increase the PV array voltage to 48 volts and to use maximum power point tracking charge controllers. In the hot, dry Southwest, PV module temperatures can exceed 75°C (167°F), and the maximum power points of the modules, when used with 24 volt connections, can be below the battery charging voltage resulting in lost energy. The use of 48-to-24 volt, maximum power point tracking charge controllers avoids this problem. The lower current at 48 volts reduces voltage drop and subsequent energy loss in these circuits.

The battery bank will consist of sixteen L-16 batteries rated at 33.6 KWH at 24 volts DC. A single DC

### LaPointe PV System Loads

	Watts	Hours per Day	Winter		Summer		Avg. Daily KWH
			Days per Week	Avg. Daily KWH	Days per Week	Avg. Daily KWH	
<i>Kitchen</i>							
Energy Star refrigerator*	110	12.00	7	1.320	12.00	7	1.320
Energy Star microwave*	1,100	0.50	7	0.550	0.50	7	0.550
Vented range hood	150	1.00	5	0.107	1.00	5	0.107
Dishwasher*	350	1.00	2	0.100	1.00	2	0.100
Cell phone recharger	4	24.00	7	0.096	24.00	7	0.096
Toaster*	800	0.05	5	0.029	0.05	7	0.040
Garbage disposal	350	0.10	7	0.035	0.10	7	0.035
<i>Utility Room</i>							
Swamp cooler*	300	0.00	0	0.000	18.00	7	5.400
Energy Star clothes washer	165	2.00	3	0.141	2.00	3	0.141
Domestic water pump	240	0.35	7	0.084	0.45	7	0.108
Clothes dryer, propane heated	150	1.00	3	0.064	1.00	3	0.064
Heater controls & pumps	50	12.00	7	0.600	0.00	0	0.000
<i>Miscellaneous</i>							
Vacuum cleaner	1,400	1.00	2	0.400	1.00	2	0.400
Smoke alarms	12	24.00	7	0.288	24.00	7	0.288
Ground fault circuit interrupt	10	24.00	7	0.240	24.00	7	0.240
Hair blow dryer*	1,100	0.25	5	0.196	0.25	5	0.196
Linear tube fluorescent lighting	104	4.00	6	0.357	3.00	4	0.178
2 Clock radios	6	24.00	7	0.144	24.00	7	0.144
Compact fluorescent lighting*	60	2.00	7	0.120	2.00	7	0.120
Satellite receiver & TV	100	2.00	5	0.143	2.00	3	0.086
4 Ceiling fans	15	0.00	0	0.000	8.00	5	0.086
Halogen lamps	100	1.00	3	0.043	1.00	3	0.043
2 Bathroom fans	20	2.00	7	0.040	2.00	7	0.040
DVD player	20	2.00	3	0.017	2.00	3	0.017
Satellite receiver & TV	100	2.00	1	0.029	1.00	1	0.014
VCR	20	1.00	1	0.003	1.00	1	0.003
<i>Worst Case Instantaneous Use*</i>	3,820		<i>Total Winter</i>	5.146		<i>Total Summer</i>	9.817

enclosure will contain a 250 amp battery disconnect, two 75 amp PV subarray disconnects, a 175 amp main PV disconnect, and a 15 amp DC pump disconnect. All disconnects are DC-rated circuit breakers with interrupt capabilities of at least 25,000 amps. These circuit breakers will provide the code-required overcurrent protection for the associated conductors.

A worst-case instantaneous load may occur in the morning if two people are early risers. This type of peak load has happened in my house more than once, and might consist of:

- Hair dryer: 1,100 watts
- Microwave: 1,100 watts
- Toaster: 800 watts
- Swamp cooler: 300 watts
- Lights: 60 watts
- Dishwasher: 350 watts
- Refrigerator: 110 watts

The total AC load for this scenario would be 3,820 watts.

A 24 volt, 4,000 watt inverter will provide the house with 120 volt, 60 Hz alternating current. It has sufficient steady-state output to handle the expected worst-case load and short-term (15 minutes) surge capabilities for added uncertainties. A generator fueled with propane

### Selected Topics from Past *Code Corner* Columns

Subject	Home Power Issue
Ampacity	67, 68, 76, 77, 78, 83
Battery circuits	46, 48
Circuit breakers	50, 52, 54, 68, 84, 85
Conductors & cables	49, 51, 55, 76, 77, 78, 79, 80, 81, 82, 83, 91
Conduit	49, 50, 60, 62, 83
Design	92
Disconnects	42
Grounding	43, 44, 58, 64, 65, 72, 73, 74, 91
Hybrid systems	48
Lightning	57
Listed equipment	43, 56, 76, 77, 82
Multiwire branch circuits	54, 59
Outside resources	92
PV modules	79, 81, 83, 91
Stand-alone systems	46, 48
Voltage drop	80, 81, 83

and rated at 6.5 KW (sea level rating) will provide backup during extended periods of cloudy weather or when loads exceed energy production from the PV system.

The entire system will use listed components (where available). It is designed and will be installed in full compliance with the *National Electrical Code (NEC)*. Relevant *NEC* sections are cited here for design decisions.

### Array Location, Module Mounting, & Connections

The array was initially going to be mounted on the roof of the home. "Not on my beautiful roof," said the architect. An array site north of the house was considered, but shading from the house required that it be placed too close to the property line, and the homeowner thought that it was too visible in that location. Finally, the array was sited to the south of the house, adjacent to the driveway, and slightly below the level of the house on the side of an arroyo.

The PV output circuit lengths went from about 50 to 150 feet (15–46 m) when the array site was moved from the roof to the arroyo. This move reduced system costs by eliminating the requirement for an *NEC* 690.5 ground fault protection device, but increased the costs for the array-to-charge controller wiring and the ground mount.

Adjustable aluminum racks will hold the modules in groups of four. The racks will be attached to a set of eight, 2 inch galvanized pipes set in concrete that will be topped with lengths of galvanized steel channels. Nearly all of the hardware used for these mechanical connections will be made of stainless steel.

Additional lengths of #10 (5 mm<sup>2</sup>) USE-2/RHW-2 conductors will be spliced to the short pigtails on the modules using solder and UL-listed, thick-wall heat shrink tubing with internal adhesive [110.14(B)]. These conductors will be routed along the module and rack channels and fixed in place with rubber-insulated, stainless steel clamps. Stainless-steel hardware will be used to install the clamps and the fused combiner boxes that are to be attached to the array support rack in the shaded area under the PV array.

Plastic, outdoor-rated strain reliefs (cord grips) will provide mechanical protection for the module conductors entering the combiner boxes [300.4]. Conduit will be used between the combiner boxes and the DC equipment center located some 150 feet (46 m) away [352]. Ampacity calculations and voltage drop calculations dictated that the circuit conductors for each subarray be sized at #1/0 (53 mm<sup>2</sup>) with a #2 (33 mm<sup>2</sup>) equipment-grounding conductor [690.8, 9, 45]. USE-2/RHW-2 conductors will be used for the underground,

# Judy LaPointe's Photovoltaic System

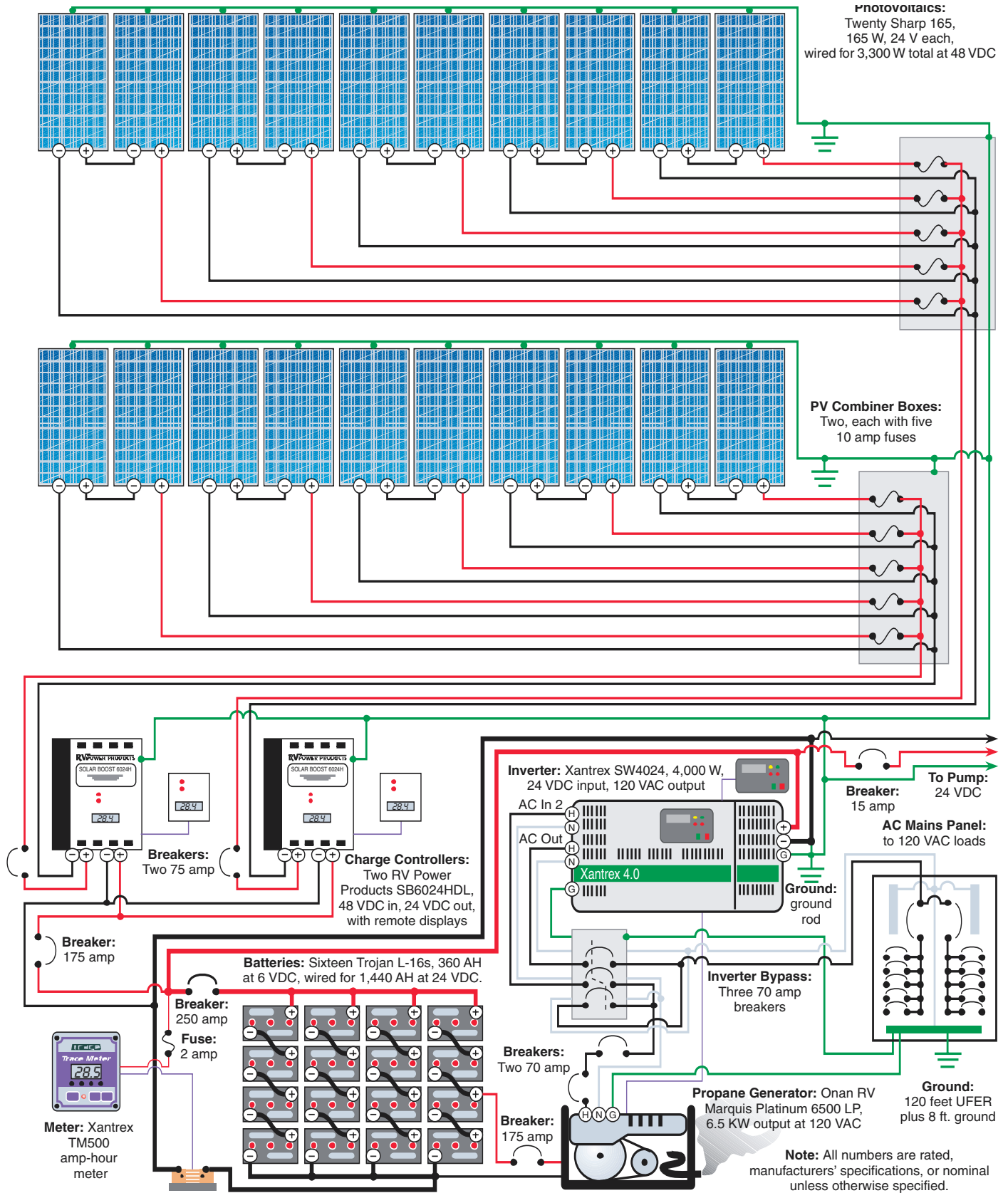

conduit-enclosed PV output conductors to provide additional durability [338].

### Module Grounding

The modules will be grounded with a #8 (8 mm<sup>2</sup>) bare conductor connected to the designated grounding point on each module using the hardware provided with an appropriate lug [690.45]. These module equipment-grounding conductors will be connected to an equipment-grounding bus bar in the combiner boxes.

The module mounting racks will also be connected to the same bus bars, as well as connected to the grounding system at the module location. Two supplemental ground rods will be driven at the PV array location and, with the rack support pipes, will form an effective supplementary grounding system to meet code requirements and provide added lightning protection [250.54].

### Generator Starting Circuit

One of the four strings in the battery bank will be tapped at the 12 volt point to supply the DC electricity to start the generator. This circuit will consist of #2/0 (67 mm<sup>2</sup>) conductors run in 2 inch conduit and protected by a 175 amp circuit breaker [310.16].

### Water Pump

The DC water pump draws a maximum of 11 amps. A 15 amp circuit breaker will protect the circuit conductors. Minimum conductor size, based on ampacity requirements, is a #14 (2 mm<sup>2</sup>) conductor. A #8 (8 mm<sup>2</sup>) conductor will be used to lower the voltage drop in the circuit. A 3/4 inch conduit will be used for this circuit.

### DC Power Center Lighting

A 24 volt DC fluorescent lamp will be installed above the power center area to provide emergency lighting. It draws 2 amps, will be wired with #14 (2 mm<sup>2</sup>) conductors, will be controlled by a DC-rated wall switch, and will be powered via the 15 amp circuit breaker used by the water pump. A 1/2 inch conduit will be used for this circuit.

### AC Circuits—Generator

A 70 amp circuit breaker will be used at the generator to serve as overcurrent protection for this circuit and as a disconnect located outside at the generator [240.4, 21]. A second 70 amp circuit breaker will be installed in the garage near the inverter and the inverter bypass switch to serve as an inside generator disconnect. All disconnects from all power sources must be grouped together [690.14].

### Inverter Bypass

The inverter bypass switch will consist of a pair of 70 amp circuit breakers (a double-pole and a single-pole)

mechanically interlocked so that only one of the pair may be turned on at a time. This pair of circuit breakers will serve as a bypass switch for the inverter. They will be used only when the inverter becomes inoperable and must be removed for repairs. One of the 70 amp breakers will serve as an overcurrent device for the AC output circuit from the inverter (or generator) to the house load center.

### House AC Load Center & AC Circuits

The 200 amp AC load center will have both of the ungrounded inputs (Line 1 and Line 2) connected in parallel and then to the 70 amp breaker in the inverter bypass switch [240.4, 21]. This configuration will provide the house with a single 120 volt, 60 Hz service at up to 70 amps, with a continuous rating of about 56 amps (0.8 *NEC* derating factor x 70 A). No multiwire branch circuits will be installed in this house, and appropriate labels will be applied to the house AC load center [690.10(C)].

The house will be wired with several 240 volt AC circuits, and outlet boxes will be installed. Most 240 volt loads are not generally consistent with energy conservation or the limited energy available from this system. The 240 volt circuits will be added to facilitate the sale of the house to any future owner who might bring in the utility lines.

No 240 volt receptacles will be installed, and each 240 volt outlet will be covered with a blank cover plate. None of the 240 volt circuits will be connected in the load center, but sufficient wire will be allowed for future connection if 240 volt circuit breakers are added. The 240 volt circuits will include: electric range, electric dryer, electric space heater, refrigerated air conditioning system, and heated whirlpool bath. These 240 volt circuits will not be used in any way as part of the 120 volt wiring [690.10].

### Grounding System

All of the rebar in the house's foundation is bonded together and also bonded to a 120 foot (37 m), #4 (21 mm<sup>2</sup>) conductor buried in the bottom of the footer trench [250.52(A)(3)]. This conductor is run without splicing to the grounding block (bonding point) in the DC disconnect. A #4 grounding electrode conductor is also run from the AC load center bonding point to a point on the DC grounding electrode conductor where it enters the slab. At that point, the two electrodes are spliced with an irreversible splicing device [250.64(C)].

A supplementary 8 foot (2.4 m) ground rod is located about 7 feet (2.1 m) from the point where the #4 grounding electrode emerges from the slab, and this rod is also connected with an irreversible splice to that conductor [250.53(B)].



## Summary

Designing and planning for a safe, reliable, and durable off-grid PV system (or any PV system for that matter) requires a considerable effort. The use of materials like stainless steel hardware and rubber-insulated conductors helps to improve the system reliability and durability. My next column will explain many of the calculations referenced here. In a future issue, photos and additional descriptions of the system will be presented, after the construction of the house and the system installation are completed.

If you have questions about the *NEC*, or the implementation of PV systems that follow the requirements of the *NEC*, feel free to call, fax, e-mail, or write. From time to time, longer, more detailed versions of the Code Corner columns will be posted on the SWTDI Web site. Sandia National Laboratories sponsors my activities in this area as a support function to the PV industry. This work was supported by the United States Department of Energy under Contract DE-FC04-00AL66794. Sandia is a multiprogram laboratory operated by Sandia Corporation, a Lockheed Martin Company, for the United States Department of Energy.

## Access

John C. Wiles • Southwest Technology Development Institute, New Mexico State University, Box 30,001/MSC 3 SOLAR, Las Cruces, NM 88003 • 505-646-6105  
Fax: 505-646-3841  
jwiles@nmsu.edu  
www.nmsu.edu/~tdi/pv.htm

Sponsor: Sandia National Laboratories, Ward Bower, Department 6218, MS 0753, Albuquerque, NM 87185  
505-844-5206 • Fax: 505-844-6541  
wibower@sandia.gov  
www.sandia.gov/pv

The 2002 *NEC* and the *NEC Handbook* are available from the National Fire Protection Association (NFPA), 11 Tracy Dr., Avon, MA 02322 • 800-344-3555 or 508-895-8300 • Fax: 800-593-6372 or 508-895-8301 • custserv@nfpa.org  
www.nfpa.org



**FEEL THE HEAT**

## Solar Training in Albuquerque New Mexico

May 16 & 17, 2003

### Solar Radiant Floor Heating Design Workshop

Gain valuable skills and knowledge in this 1 or 2 day workshop and learn important design elements for solar radiant heating

Get Our '03 Schedule  
Call for Information & Brochure



www.usasolar.net  
(928) 282-5140

## 12 & 24 Volt DC Lighting

~from~

Montana Light,  
Low Voltage Lighting, and Thinline

In stock and ready to ship.

www.solarseller.com

(562) 423-4879, fax (562) 728-9941

John Drake Services, Inc., 1427 E. 68th St., Long Beach, CA 90805

## HELIOTROPE THERMAL



### DELTA-T

For automatic operation of solar heating systems

DTT-84 and DTT-94 controls established the standard over twenty years ago and their reliability has been proven in nearly a million installations.



### SOLAR CHECK VALVE

Low resistance spring check valve ideal in PV pumped systems

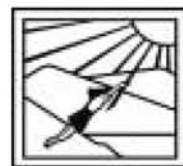

## HELIOTROPE THERMAL

4910 Seaport Ave.  
Richmond, Ca. 94804  
Tel: 510-237-9614  
Fax: 510-237-7018  
info@heliotropethermal.com  
www.heliotropethermal.com



## Net Metering Under Attack

Don Loweburg

©2003 Don Loweburg

**W**hile still flush with last year's successful PV legislation in California, recent filings by utilities and the California Public Utilities Commission (CPUC), challenging the foundations of the net metering law, should serve as a wake-up call. There is no nap time in this game.

Though both of these filings are California issues at the moment, there is no doubt that they will surface in other jurisdictions. For this reason, they are relevant to our larger national readership. The issues are exit fees, sometimes called departing load fees (charges for reducing purchased utility electricity), imposition of interconnection charges, and renewable energy credits (RECs), sometimes called green tags. Green tags represent embodied value for renewable generation, and can be traded and sold.

Exit fees have been discussed many times in past issues of *Home Power*. In *IPP* in *HP77*, about three years ago, I discussed the decision by IPP, CALSEIA, and several manufacturers to become parties to the CPUC hearings on distributed generation. These hearings are formal legal proceedings with recorded testimony, much like a court trial. Though costly, this is the venue of the big players, and the PV industry needs to be represented.

Through this representation, our parties were able to present, for the record, the Independent Clean Energy Tariff (ICE-T). ICE-T asserted that PV was a "preferred" clean energy source and for this reason, PV installations up to 1 megawatt should be exempt from any exit fees or any other surcharges levied on clean, independently distributed generation. The CPUC has decided affirmatively on ICE-T while other issues are being considered in its proceedings on distributed generation (OIR 99-10-025).

Meanwhile, during the last several legislative cycles, the net metering law evolved into the latest incarnation, AB58. Net metered PV systems up to 1 megawatt are now possible. The PV industry engaged in a two-tracked effort, one regulatory and the other legislative. Those tracks have converged. On the one hand, we can claim success. But our success has unleashed, once again, a utility attack on PV.

### Utility Attack on PV

During the first weeks of January 2003, California's three investor-owned utilities (IOUs) filed advice letters with the CPUC requesting permission to charge exit fees for net metered customers. An advice letter is a procedure usually reserved for requesting minor changes from the CPUC. In this case, the utilities are using the advice letter process to make an end run and slip their challenge of the net metering laws past the opposition.

Also, all three IOUs have filed interconnection cost studies with the CPUC, documenting interconnection costs they intend to pass on to net metered customers. A final assault comes from the CPUC itself. A recent draft decision (R.01-10-024) regarding distributed generation and California's recently passed renewable portfolio standard (RPS) gives the renewable energy credits (RECs) of RE producers to the utilities. Taken together, exit fees, interconnection charges, and the loss of title to the RECs significantly erode the economic value of installing PV generation. These are utility tactics designed to obstruct the rapid growth of PV generation in California. If they can do it here, they can do it in other states too.

### RE Industry Response

California Solar Energy Industries Association (CALSEIA) has filed protests in response to each of the above assaults. With respect to the exit fees and interconnection charges, CALSEIA is drawing on testimony during the previous CPUC proceeding on distributed generation (OIR 99-10-025). At this proceeding, PV generation was accepted as a "preferred" generation technology that should be exempt from any exit or interconnection fees.

Additionally, CALSEIA argues that the exit and interconnection fees requested in the advice letters violate the net metering law, specifically Public Utility Code 2827. CALSEIA also argues that the utility's use of an advice letter is an inappropriate mechanism since the issues of exit fees and interconnection costs are properly part of OIR 99-10-025, and that decision has yet to be fully adopted.

The decision by the CPUC to assign renewable energy credits (RECs) to the utilities is being protested primarily on the grounds that this is a "taking" by the utilities of property belonging to the renewable generator. The value of RECs lies in the fact that they are saleable. The owner of a renewable generating system, CALSEIA asserts, owns both the energy output and the RECs.

The whole idea behind the renewable portfolio standard is to create a demand for renewable energy while relying on market forces to work out the details. The RPS just enacted in California sets a target of 20 percent renewable energy in the utility mix by 2017. One choice the utilities have in meeting this target is to generate that energy themselves. Another option in achieving that goal is to purchase RECs from independent renewable generators.

The value of RECs at any given moment will be determined by the market forces of supply and demand. Even small renewable generators, such as net metered residential PV installations, could participate in the market for RECs. A California residential system with a 2.5 KW PV array may produce around 5,000 KWH (5 MWH) per year. A purchaser of RECs could set up a Web site to which many residential systems could log their annual output. The aggregator would in turn sell the bundled RECs to a utility that requires credits to achieve their portfolio requirement.

### **An Example**

Let's assume 2,000 grid-connected PV homes in California today. In one year, these systems will produce about 10,000 megawatt-hours (MWH). No one knows the value of a REC at this time. But, as an exercise, assume each KWH has a "green" value of US\$0.02. Under this assumption, a megawatt-hour would be worth US\$20, and each household would get US\$100 per year income from their green electricity.

Over the 30 year lifetime of the system, each homeowner might receive RECs worth more than US\$3,000 (presuming that the portfolio standard continues that long). Collectively, these RECs would be worth about US\$200,000 per year. This is a significant amount, and the utilities cannot just take it. I don't know anyone who is willing to give away the benefit of their renewable generation to a utility.

### **State by State**

It is my assumption that these same issues will recur in other states as they implement successful PV programs. It would be great if we could do this work once at the national level, but it is a wasteland in Washington, D.C. as far as renewables are concerned. I see a state-by-state battle.

First, state coalitions should get strong and ample net metering laws enacted legislatively. Then be prepared to defend, in the regulatory arena, against interconnection charges and exit fees while protecting the ownership rights to the green benefits of PV generation.

In California, we are very lucky to have great talent and resources committed to our solar future. Ed O'Neil, counsel for CALSEIA, has been a big asset. He is committed to our goals and understands intimately the workings of the CPUC. He has been generous to IPP and has made his work available to us.

This information is public record and if anyone wishes, IPP can provide copies electronically. This may avoid wasted time searching the CPUC Web site. This information could be valuable to those in other states seeking a road map of action regarding the issues we have been discussing.

---

### **Changes in the California Buydown Program**

Due to the extreme success of the California buydown program, funds ran out on October 31, 2002. Though temporary, the program will resume in early 2003, with new funding for the next five years. The funding interruption stressed many companies doing solar business in California. Especially impacted were companies that had hired new employees or taken on debt in response to the PV boom in California.

The California Energy Commission (CEC) did an admirable job of maintaining the funding for the program prior to the cutoff. During the last two years, program disbursements were almost US\$40 million per year, far in excess of the original funding allocation. The CEC had, up to the cutoff in October, managed to move money from undersubscribed programs over to the buydown program. They made it very clear, however, that there will be no additional "boosts" in the future.

Because the new funding for 2003 and subsequent years is capped at US\$24 million per year, it was obvious to all that some changes needed to be made. It would be intolerable if the program ran out of money six months into each year. Few companies could exist under this start-stop scenario. The program changes can be put into two categories—changes in the funding amount and changes affecting the way systems are rated and specified.

### Funding Changes

The situation is very clear. Based on the last two years' level of subscription, the new funding amount must be stretched. Hence, a lower dollar per watt rebate and a reallocation of funds by size and technology seem to be the only remedy for the moment. Here are the details:

- The basic rebate amount drops from US\$4.50 to US\$4 per rated watt for PV systems under 30 KW that are professionally installed.
- PV systems that are owner installed will receive US\$3.40 per watt.
- Wind-electric systems 5 KW or smaller receive US\$2 per watt. Outputs above 5 KW but less than 30 KW will receive US\$1.50 per watt. Owner-installed systems will receive US\$0.50 per watt less.
- RE systems under 30 KW will be allocated 90 percent of available funding. Systems 30 KW and larger will receive 10 percent.
- The CEC has the option to drop the rebate amount by US\$0.20 every six months if they choose.

### Rating & Specifications Changes

Buydown program changes affecting system rating, specification, and performance include:

- Performance metering is required on all systems.
- Non-grid-interactive inverters will not be eligible after March 31, 2003.
- Retailers will be required to provide resale license numbers.
- The reservation request form requires a system output estimate.
- Inverter efficiency will be measured at 75 percent of rated output.

In IPP in *HP85* and *HP86*, a case was made for inverter output metering and for system energy output predictions to be supplied to the customer. Our support continues for these measures, and we commend the CEC for tightening up the program.

### Dealer Objections

Some dealers have objected to these requirements. They contend that a second meter for system output is contrary to the net metering law and would invite utilities to monitor system output as a way of charging exit fees based on system production. However, this is not what the CEC wants (and neither do I).

The requirement for performance metering is so the customer knows that their system is functioning properly. In fact, digital metering is an inverter option,

and generally the inverter need not be accessible to the utility. If a separate meter were used, it would be prudent to locate it in an area inaccessible to utility personnel.

Some dealers are reticent to provide a warranted system output estimate. Maybe they should be! Competent, full service dealers working in their local area should be able and eager to predict system output as a means of distinguishing themselves from less qualified competitors. Ultimately, the product is electricity. Customers should know how much electricity they can expect from the systems they purchase.

Dealers who object to output commitments for the systems they install cite the possibility that circumstances beyond their control would diminish the system's output. Situations such as tree growth shading the array or unusual weather patterns are given as examples. However, these kinds of situations can easily be dealt with and should not be used as excuses to shield the system seller from their accountability for system performance.

### Access

Don Lowebug, IPP, PO Box 231, North Fork, CA 93643  
559-877-7080 • Fax: 559-877-2980 • [i2p@aol.com](mailto:i2p@aol.com)  
[www.i2p.org](http://www.i2p.org)

Edward W. O'Neill, Davis Wright Tremaine, LLP, One Embarcadero Center, Suite 600, San Francisco, CA 94111 • 415-276-6500 • Fax: 415-276-6599  
[edwardoneill@dwt.com](mailto:edwardoneill@dwt.com) • [www.dwt.com](http://www.dwt.com)

CALSEIA, PO Box 782, Rio Vista, CA 94571  
949-709-8043 • Fax: 949-709-8044 • [info@calseia.org](mailto:info@calseia.org)  
[www.calseia.org](http://www.calseia.org)

California Energy Commission (CEC) 1516 9th Street, MS-2, Sacramento, CA 95814 • 800-555-7794 or 916-654-4058 • Fax: 916-653-2543  
[renewable@energy.state.ca.us](mailto:renewable@energy.state.ca.us)  
[www.consumerenergycenter.org/buydown](http://www.consumerenergycenter.org/buydown)



**CHEAPESTSOLAR**  
**.COM**



## Cut Your Own Lumber!

### Model 613

**LUCAS MILL**  
THE ULTIMATE PORTABLE SAW MILL



Call for  
Free Brochure  
and Video

U.S. Pat. No. 5,819,626/Australian Pat. No. 688020

**Call For  
Prices!**

### The Ultimate Portable Saw Mill

#### PACKAGE DEAL INCLUDES:

- Engine & Saw Carriage
- 2 - Sets of End Frames & Braces
- 2 - Hold Down Spikes
- 2 - 17" Carbide-Tipped Saw Blades
- 12 Volt Diamond Wheel Grinder
- Swing Blade Sawing System
- 2 - 19 ft. 4 in. Tracks
- Extra Gas Filled Strut
- 2 - Year Warranty (Engine and Mill)

Offer ends 06/30/03

© 2003 Bailey's Inc.

**Bailey's**  
Est. 1975

The World's Largest Mail Order  
Woodsmen Supplies Company -  
Selling at Discounted Prices.

Call today and  
mention source  
code: H7Q5  
for your FREE  
Master Catalog



**TOLL FREE 1-800-322-4539 TOLL FREE**

[www.baileys-online.com](http://www.baileys-online.com)



**xantrex**  
Certified Dealer  
RENEWABLE POWER SYSTEMS

### Alternative Energy Solutions

195 N. Edison Suite 16, Reno, Nevada 89502  
1.866.491.SOLR • [www.SolarWindHydro.com](http://www.SolarWindHydro.com)

**Xantrex Authorized Service Center**

### Vermont Solar Engineering

**xantrex**  
Certified Dealer  
Charter Member

**Sale!**

Servel LP Gas Fridge  
Many features. 8 cu. ft.  
\$1049 plus freight

Chargeboost™ Transformer  
Squeezes the maximum current from a modified sine-wave inverter's battery charger. If your charger and generator are not performing well together, you'll be impressed with the results. The model suited for 2.0-3.6 kW inverters is well worth the cost of \$139.

Free catalog: call, write, or view online.



Dealer inquiries  
welcome

We take pride in being a hands-on dealer/designer/installer, who works with PV, wind, & domestic hot water everyday. Give us a call. Thanks! Attractive pricing and expert support. 1-800-286-1252.

PO Box 697                      vermontsolar.com                      802-863-1202  
Burlington VT 05402              backeastsolar.com                      f: 802-863-7908

**[www.backeastsolar.com](http://www.backeastsolar.com)**

## SOLAR ATTIC FAN



- \* Installs in Minutes
- \* Quiet Operation
- \* Variable Angle Siemens Panel
- \* Up to 850 CFM
- \* Adaptable to any type of roof
- \* All Aluminum Construction

### Natural Light Tubular Skylights

**800-363-9865**

[www.natural-light-skylights.com](http://www.natural-light-skylights.com)

### Phoenix Composting Toilet System

Odorless • Waterless • Large Capacity  
Low Energy Requirements • Owner-Friendly

Advanced Composting Systems  
195 Meadows RD  
Whitefish, MT 59937  
Voice: 406-862-3854  
Fax: 406-862-3855  
phoenix@compostingtoilet.com  
[www.compostingtoilet.com](http://www.compostingtoilet.com)

Sunergy Systems, LTD  
Box 70, Cremona AB T0M 0R0  
Voice/fax: 403-637-3973  
sunergy@telusplanet.net  
In British Columbia:  
Voice: 250-751-0053  
Fax: 250-751-0063

## ELECTRIC GORILLA



Looks and feel of an ATV

Tough and powerful like a little tractor

Smooth and quiet as an electric golf cart

- Ranch / Farm / Parks
- Security Patrols
- Worksites / Campus
- Neighborhood NEV
- Resort - Rentals
- FUN

Charge from your  
Solar, Wind or  
Hydro system



Heavy-duty construction.  
Almost maintenance free.  
650 lb load, 4000 lb tow.  
Hi-impact plastic body.  
Road, turf, or knobby tires.  
12 to 23 Mph top speeds.  
24 and 36 volt versions.  
Built-in 110-volt charger.  
Proudly Made in the USA

By **Gorilla Vehicles, LLC™**

5672 Littler Drive, Huntington Beach, CA 92649 USA  
[info@GorillaVehicles.com](mailto:info@GorillaVehicles.com) (714) 377-7776

See our website, or contact us for a brochure package.

**[www.GorillaVehicles.com](http://www.GorillaVehicles.com)**

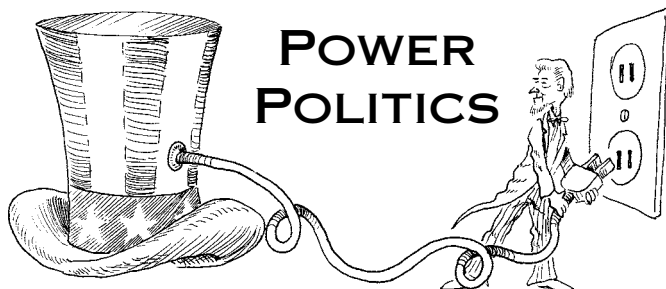

## Energy Notes

Michael Welch

©2003 Michael Welch

**W**ill there be an energy bill this year? If so, what can we do about it? While we wait patiently to find out, there have been some pretty interesting developments in the world of energy politics.

Some activists feel that there may not be an energy bill at all this year, and are hoping we can deal with each related issue as it comes up separately. My sense is that there will be an energy bill, and that Bush will submit what he wants to Congress—about the same as last time. I also think that whatever he submits will have a tougher road getting through this time.

Sure, both houses are now controlled by the Republican party, but there probably will be much more tendency toward partisanship among the Democrats, who are feeling a renewed need to redefine their actions and distinguish the party from the Republicans. That makes it less likely that they will support Bush's corporate-friendly energy plans, as was their tendency just after the September 11 tragedy. Plus, the Democrats have new leadership that may be able to understand just a bit more the need for progressive energy policy change in the U.S.

### New Apollo Project

One energy policy initiative that you should contact your representatives about is the New Apollo Project, begun by Representative Jay Inslee of Washington State. A letter from Inslee to his congressional colleagues includes this synopsis:

The New Apollo Project will marshal the resources of the federal government to provide a vision of how to solve the following challenges: 1) breaking our

addiction to Mideast oil and thereby improving our homeland and national security; 2) how to address the threat of global warming; and 3) how to expand our economy and create jobs.

Please write your representatives in Congress and ask them to support this idea. It is one of the few projects going right now that attempts to influence overall U.S. energy policy before any bills are introduced. The full text of Inslee's letter to his colleagues can be downloaded from our Web site, and an editorial from Inslee on the project can be read at [www.commondreams.org/views02/1219-04.htm](http://www.commondreams.org/views02/1219-04.htm).

### Citizen Lobbying

In *HP93*, I talked about organizing citizen lobbying actions. Folks could travel to Washington, D.C. or visit representatives in their local offices to let them know how important RE is to the next energy bill and our future. I thought that organized citizen lobbying was a fresh idea that had not been used often. But I recently came across a program called "DC Days."

This citizen lobbying program is spearheaded by the Alliance for Nuclear Accountability, and they focus mostly on nuclear weapons issues. They invite citizen activists to Washington, D.C., give them materials to study, set up lobby training sessions, and help them to set up meetings with their representatives. Even though their focus is slightly different than my proposal last issue, their Web site has some very good organizational and recruiting tips for citizen lobbying. See *Access* for more info.

### Oily Alphabet Soup: ANWR & NPR-A

No, the Arctic National Wildlife Refuge is not a place where Canadian party-goers can hide out. It is a place of sensitive habitat, where caribou and many other tundra species are supposed to be able to hang out unhindered. But the oil companies and their political hit men still want the oil and gas that is underneath the area, and will be introducing bills and riders in Congress this year to try to get their way.

Having Richard Pombo as the chairman of the House Resources Committee will help them out. His mantra seems to be, "Turn it brown." He is no friend of the environment. Of course, the Bush administration will be doing whatever it can outside of Congress to help out their oil company friends.

For example, to the west of ANWR is the misnamed National Petroleum Reserve—Alaska (NPR-A). In January, the U.S. Bureau of Land Management issued its Draft Environmental Impact Statement aimed at opening up 9 million acres of this area to oil and gas exploration. NPR-A is the nation's largest remaining

block of unprotected land, is mostly wilderness, and definitely should be protected. It was set aside in the 1920s as a reserve in case the military needed the oil, but the Bush administration is looking to change that.

“Alaska’s Western Arctic is a jewelry box of precious gems,” said a recent press release from the Alaska Wilderness League and other concerned organizations. For more info and what you can do, check out [www.alaskawild.org/new.html#NPRA](http://www.alaskawild.org/new.html#NPRA).

### **Solar & Wind Powered Nuke Waste Dump?**

The Bush administration and the nuclear power industry have been trying to figure out creative ways to fund the Yucca Mountain high-level nuclear waste repository. Meanwhile, anti-nuclear experts and activists have been playfully speculating on how the ventilation systems at the dump might be powered and maintained for the tens of thousands of years that the stored, irradiated fuel rods will put out heat.

What brought this up was a notice in the *Federal Register* announcing that the Department of Energy would not pursue placing 600 MW of wind generators at the nearby Nevada Test Site (where nuclear weapons are tested). Apparently the Air Force is afraid their planes might run into them on training missions from the nearby Nevada Test and Training Range. Activists assume that the Air Force would shoot down using windmills at Yucca for the same reasons as at the test site.

Further discussion among activists revealed that the DOE actually has plans for Yucca Mountain to include a mountainside full of solar-electric panels to help power the facility. But the proposed solar-electric array is oriented in the wrong direction! I find the DOE’s faith in the longevity of solar-electric panels to be encouraging, but can they outlast nuclear waste? Maybe we can get Shell Solar to extend their 25 year module warranty just a bit more...

Final speculation came from Kalynda Tilges, executive director of the Shundahai Network, “I believe they are planning to run it on the gaseous emissions from the administration, so it becomes just a pipeline thing.” Who says anti-nuclear activists don’t have a sense of humor?

### **“Temporary” Nuke Waste Storage**

In a letter to the 108th Congress, Public Citizen, Redwood Alliance, and many other energy-related organizations have requested Congressional intervention to prevent Nuclear Regulatory Commission licensing of an aboveground, high-level nuclear waste storage facility in Utah. (See *HP46, Power Politics*—yes this has been going on awhile.)

For many of the same reasons, this facility at the Goshutes reservation in Skull Valley is as bad an idea as

the Yucca Mountain repository. Nuclear transportation, environmental degradation, and foisting the facility on a community that doesn’t want it are all factors in common. This particular project adds the concerns of higher security risks from the accessible, aboveground placement of the waste, and the concept of “environmental injustice” because the tribal members are poor and underprepared to fight off the powers that be.

A rather powerful consortium of nuclear utilities wants the dump built, and the NRC is willing to oblige. A majority of tribal members are against the dump, but tribal officials see little more than the dollars involved. For details, see [www.shundahai.org/PFS.pdf](http://www.shundahai.org/PFS.pdf).

### **Below Regulatory Concern**

The very same NRC is also trying to send radioactive materials into your homes. Yes, BRC is back. This is the concept that some radioactive materials restricted in the past are not radioactive enough to justify such restriction. But really, it is just an excuse for the nuclear industries to avoid paying for disposal of these low-level wastes.

The DOE thinks it will be OK to release slightly radioactive materials for recycling into consumer goods or just to be placed in our landfills. Just imagine, a frying pan that works without electricity or gas. (Well, not that radioactive, but you get the point.) After regulators in the Bush 1 administration affirmed states’ rights in this matter, and after the Clinton administration made it clear that they did not want these materials foisted on the public, the Bush 2 nuclear regulators have decided that now would be a good time to get this kind of nuclear waste out of utility and government facilities.

### **NRC Committee Nominee**

Traditionally, NRC commissioners and committee members have come straight from the nuclear industry, a revolving-door policy. Rarely have there been commissioners whose main interest is protecting the public, which is the NRC’s stated mission. They usually seem to view their purpose as figuring out how to give the nuclear industry what it wants, and still appear to be within the letter of the law. And if a law goes against industry wishes, they and the nuclear industry work hard to get the law changed.

All NRC commissioners have been pro-nuclear in the past. But at least a very small number (I can think of only one, actually, but maybe there were more) have willingly placed safety, health, and environmental concerns ahead of nuclear industry profits.

Really, we need at least some commissioners who represent those of us more interested in those three concerns than in corporate profits. Right now, there is

an opening on the NRC's Advisory Committee on Nuclear Waste. While it is not as powerful as the Commission itself, getting a good person in there would be a great start. Public Citizen has nominated Dr. Marvin Resnikoff to the opening.

Resnikoff is a senior associate with Radioactive Waste Management Associates. He has worked with many stakeholders in nuclear issues, providing independent analysis of nuclear waste transportation, storage, and disposal projects. He is well thought of among energy activists.

### Missing Nuclear Fuel Rods

The NRC has announced that it will seek public comment on its analysis of the recent disappearance of two reactor fuel rods. I wonder what we, the public, can say about that? "Whoops!"? These rods were last seen in 1980 in the spent fuel pool at the Millstone nuclear power plant in Connecticut. In December 2000, workers were inventorying the pool in preparation for selling the plant, and could not find them.

The NRC thinks the rods most likely were accidentally shipped to the low-level waste dump in Hanford, Washington or maybe Barnwell, South Carolina. But the NRC is not worried. Even though the rest of the waste is supposedly "low-level," they say the two rods only contain 460 curies of radiation, whereas more than a million curies are stored in the section of the Hanford dump where the rods may have ended up.

Why are they calling those dumps "low-level" if they contain over a million curies of radiation? A curie is a lot of radiation, the disintegration of 37 billion atoms per second. As a comparison, all of the 423 aboveground nuclear weapons tests together are estimated to have released 11 to 13 million curies of the strontium 90 isotope into the environment.

And the NRC is not worried? Hey, I'm worried. How many other fuel rods are missing? Are there enough missing to create a nuclear explosive device? What if these rods are actually in the hands of a terrorist organization and being made into a "dirty" bomb? What if the CIA, another terrorist organization, has them and intends to make a dirty bomb to use and blame on foreign terrorists? To paraphrase Dave Lochbaum of the Union of Concerned Scientists about these missing irradiated fuel rods, "They'd better hurry up and open Yucca Mountain, before *all* the irradiated fuel disappears."

Peace.

### Access

Michael Welch, c/o Redwood Alliance, PO Box 293, Arcata, CA 95518 • 707-822-7884

michael.welch@homepower.com  
www.redwoodalliance.org

Alliance for Nuclear Accountability, 1801 18th St. NW, Suite 9-2, Washington, DC 20009 • 202-833-4668  
Fax: 202-234-9536 • anaintern@earthlink.net  
www.ananuclear.org/organizingathome.htm &  
www.ananuclear.org/recruiting.htm

Shundahai Network, 1350 E. Flamingo, Box 255, Las Vegas, NV 89119 • 702-369-2730 • Fax: 702-369-5717  
kalynda@shundahai.org • www.shundahai.org

Public Citizen's Critical Mass Energy & Environment Program, 215 Pennsylvania Ave. SE, Washington, DC 20003 • 202-546-4996 • Fax: 202-547-7392  
cmep@citizen.org • www.citizen.org/cmep

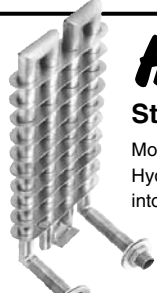
**HYDRO-COIL** *Get yourself into Hot Water*  
**Stainless Steel Water Heaters**  
More than 30% of your wood heat is lost up your chimney. Hydro-Coil can show you how to convert your wood stove into a water heater, saving you money and energy.  
[www.hydro-coil.com](http://www.hydro-coil.com)  
**(530) 272-5096**



**SUNELCO**  
THE SUN ELECTRIC COMPANY  
[www.sunelco.com](http://www.sunelco.com) • **800-338-6844**

**BATTERY BOX VENTILATOR & BACK DRAFT DAMPER**



- Positive hydrogen venting
- Stops back drafts
- Keeps batteries warmer
- Minimal power consumption
- Available in 12, 24 or 48 VDC

\* Trace SW Inverter or controller required to switch fan on/off automatically

**POWER VENT**  
12v & 24v – \$79  
48v – \$104  
+ \$8 S&H (cont. U.S.)  
CO residents add 3%



Zephyr Industries, Inc.  
POB 52, Salida, CO 81201  
**719.530.0718**  
[www.zephyrvent.com](http://www.zephyrvent.com)



# PowerPod™ corporation

Box 321 Placerville, CO 81430

- Modular integrated solar energy systems

### Use for:

- lighting
- communications
- water pumping
- small & large PowerPods with inverters up to 4000 watts AC
- small units are easily transported
- energy efficient lights & appliances also available
- Made in USA pat.#420,973



Sundance Solar Designs, our sister company, offers complete renewable energy system design/consult, sales & installation services. Home & Ranch. Solar, wind & hydro.

[www.powerpod.com](http://www.powerpod.com)  
**1 888 786-3374**

## PC Software for **TRACE** Sine Inverters

### WinVerter™ Setup for installers

- Save time programming
- Record setup of multiple customers
- Easy reprogramming

### WinVerter™ Monitor for users

- See status at a glance
- Control inverter from local PC & via remote modem
- Log meter data to file

We also sell SW communications & memory adapters  
[www.RightHandEng.com](http://www.RightHandEng.com) / (425) 844-1291

## Do We Make DC Power Systems?

- DC Standard Dimmer
- DC 2-Wire Dimmer
- DC Motor Speed Control
- DC Fan Speed Control
- DC Linear Power Supply
- DC Voltage Reducer
- DC Voltage Doubler
- DC Delayed OFF Switch

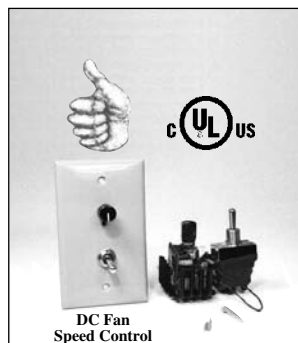

Sold Through Leading  
Distributors, Wholesalers,  
and Retailers

**ZANE**  
DC Power Systems Since 1990

510 Fruitvale Court #B, Grand Junction, CO 81504 (970) 523-5170  
Fax: (970) 523-5170 Made in USA [www.zaneinc.com](http://www.zaneinc.com)

(renewable energy  
educational display)



## greenENERGYmachine™

**Teacher' Study Guide**  
Compatible with National Science Standard.

**Green Energy Machine Includes:**

- 35 watt solar cell, 400 watt wind turbine, sealed rechargeable battery, AC inverter, voltmeter and separate amp meters.
- Produces 5 amps at 110 volts AC when fully charged.



A Product of 285 Old Country Line Rd., Westerville, Ohio 43081  
Energy Designs (614)882-0077 • FAX (614) 882-3189

[www.greenenergymachine.com](http://www.greenenergymachine.com)

## The Monolithic™ Dome

A super-strong, insulated, steel-reinforced concrete building that is energy efficient and disaster resistant. Used for homes, schools, churches, offices, stadiums, storages, cabins, and more. Built throughout the U.S. and in many other countries, for over 25 years, the Monolithic Dome is tomorrow's building available today.

- Free Brochure (800) 608-0001
- Dome Living Book with 119 Plans \$24.95
- Information Video VHS (60 min) \$19.95
- Add \$5 s/h for the book and/or video
- 177 Dome Park Pl #HP, Italy TX 76651

[www.monolithic.com](http://www.monolithic.com)



## Shell Solar Industries



### Solar Power Your Dream.

You've finally found just the right spot. A little out of the way, but good water, good soil, and even a little view. You're going to build.

Find out now just how easy it is to have a solar system to meet all or part of your electrical needs.

See Your Shell Solar Industries Pro

Shell Solar Industries can help turn your plans into reality. An economical Shell solar system can give you year after year of trouble-free electricity. And do it silently, without fuel, waste or pollution.

Office (928) 636-1001  
Fax (928) 636-1664  
[sunpower@angelfireaz.net](mailto:sunpower@angelfireaz.net)  
P.O. Box 365, 2655 N. Hwy 89  
Chino Valley AZ 86323



**HITNEY SOLAR PRODUCTS, INC.**  
Dealer Inquiries Welcome



## Renewable Energy Terms

# Insulator— Material Lacking Movable Charges

Ian Woofenden

©2003 Ian Woofenden

*Derivation: From Latin insula, island.*

In my last column, I talked about conductors, materials that allow electrons to flow easily. Copper and aluminum are the two most common conductors in electrical systems. They have only a few electrons in their atoms' outer or valence shells, and these are easily bumped out. It is the motion of these electrons or charges that carries electrical energy in wires. (See *Word Power* in *HP90* for more on the anatomy of atoms.)

But since all matter is made of charges, what keeps the flowing electrons in the wires where we want them? The answer is insulators, materials that do not allow electrons to flow easily. In wiring, common insulating materials are rubber and plastic. In other electrical applications, glass, porcelain, resin, Bakelite, and other materials are used.

Conductors have only a few electrons in their valence shell, but insulators have valence shells that are almost or completely full. Insulators also tie up electrons in strong bonds that form between adjacent atoms, making them very stable and not likely to lose electrons. While the electrons in conductors are free to wander about, the electrons in insulators tend to stay put.

A common analogy compares a pipe to a wire and water flow to electron flow. A better analogy compares a wire to a *prefilled* pipe, with the insulation acting like the material of the pipe, and the copper or aluminum conductor acting like the water in the pipe. The pipe

(wire insulation) keeps the water (charges) from going where we don't want it, and the water is ready to move when pressure (voltage) is applied. An even better analogy compares the conductor to water and the insulation to ice—charges that are “frozen” and won't flow.

Remember—a wire is not empty and waiting for electrons to fill it; it's already full of electrons, and is waiting for a force to cycle the electrons slowly through the circuit, carrying energy.

The values of conductivity and insulation are variable, depending on the circumstances. For example, while wood is usually thought of as somewhat of an insulator, if it's wet enough and the voltage is high, it can certainly conduct electricity.

Once when I was removing a Douglas-fir tree in tight quarters, I was taking a 30 foot section off the top, across a road from some utility lines. As it went over, the very tip (tiny) hit an uninsulated utility wire. At the same time, the butt of the piece separated from the trunk, and I had my hand on it. I got a goodly shock, since I was the conductor between the top and the trunk, with my spikes into the trunk and my hand on the top. It was enough to teach me that green wood is not a good enough insulator when faced with high voltage...

A variety of wire and insulation types are used in renewable energy systems. Each of these has a specific designation, such as #6 AL USE, #10 CU THHN, etc. These codes describe the characteristics and appropriate uses of each of the types of wire and insulation.

For example, “#12 CU” means a copper American Wire Gauge #12 wire (3.3 mm<sup>2</sup> in metric). The gauge and material description of the wire are primarily concerned with the conductor material. The letters that follow primarily describe the insulation around the conductor.

Different insulations have different voltage and temperature limits, moisture and ultraviolet light resistance, and needs for protective conduit. See John Wiles' *Code Corner* column in *HP76* for a detailed description of different wire types.

Conductors allow charge and energy to flow easily. Insulators inhibit charge and energy flow, keeping them where we want them—not flowing through us! Next time around, I'll talk about materials that have qualities of both conductors and insulators—semiconductors.

### Access

Ian Woofenden, PO Box 1001, Anacortes, WA 98221  
ian.woofenden@homepower.com



## OVER STOCKED SALE !

Solatron Technologies Inc. Is having an overstocked sale on premium quality Photowatt PW750-80 80 Watt Solar Modules. The PW750 is rated at 17.3 Volts @ 4.6 Amps Dimensions 48.32" X 21.72" X .96" Weight 17.16 LBS

**Only \$269.00 Each !**

And Free Shipping In Continental US

Minimum order is 2 panels

Maximum order is 20 panels per customer

# Solatron Technologies

Bringing you the power of the sun at down to earth prices ...

**Call 1-888-647-6527**

Solatron Technologies Inc.

15663 Village Drive Victorville CA 92394

[Http://www.partsonsale.com](http://www.partsonsale.com)



## SOLAR CONVERTERS INC.

**We make the best LINEAR CURRENT BOOSTERS for solar water pumping!**

**These rugged, reliable and reasonably priced boosters keep your pump running even in low sunlight conditions.**



Model: PPT 12/24 -7V

- Fused Output and Float Switch Control
- Voltage limited - some models current limited
- Wide selection of sizes from 3 - 30 amps, 6 - 90 Volts

### New Products

- Battery Desulphator, single unit 12 to 48 V nominal systems with adjustable pulse strength
- Universal Generator Starter with temperature compensation, available for AC and DC Gensets
- Additional Models of Power Tracker™ Charge Controllers with MPPT ranging from 3 - 60 amps and 1.5 V - 90 Volts

Please visit our Website for details and dealers

### SOLAR CONVERTERS INC.

C1-199 Victoria Road South, Guelph, Ontario N1E 6T9 Canada  
Phone: 519-824-5272 Fax: 519-823-0325

E-mail: [info@solarconverters.com](mailto:info@solarconverters.com) Web: [www.solarconverters.com](http://www.solarconverters.com)



# Back Issues of Home Power!

Check out our Web site: [www.homepower.com](http://www.homepower.com)  
It contains an index of all articles back to issue #1.

You can buy back issues individually (Shipping included):

- \$6.25 each for 13 and 16 through 20
- \$7.75 each for 21 through 45 (except for 35, 36, 38, 40, 41)
- \$8.75 each for 46 through 84 (except for 59-67, 79, 81-83)
- \$9.95 each for 85 through current (except for 87)

- OR -

**Special Deal: All available back issues for \$125, + S&H**

Shipping: \$20 USA, \$30 Canada, \$40 International

Check with your local library—through interlibrary loan you can get back issues.

The Jackson County Library in Oregon and the Alfred Mann Library at Cornell University have all issues.

Or, get the CD-ROMs for \$29 each Special Deal: \$150 for all seven

Solar1 (RE Basics), Solar2 (1-42), Solar3 (43-60), Solar4 (61-70), Solar5 (71-76), Solar6 (77-82), and Solar7 (83-88)

Shipping for single CDs: \$2 USA, \$3 Canada, \$4 International

Shipping for CD Special: \$8 USA, \$9 Canada, \$12 International



**Home Power, PO Box 520, Ashland, OR 97520 • 800-707-6585 • 541-512-0201**



**Good Info!  
Good Deal!  
In USA  
800-707-6585**

# Home & Heart

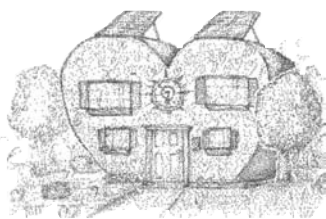

Kathleen Jarschke-Schultze

©2003 Kathleen Jarschke-Schultze

It's hard to know what else to tell you about the forest fires, beyond the tales related in my previous columns. It was, at times, a beautiful tragedy. I saw whole mountainsides on fire at night and it brought to mind lighted Christmas trees, the branches of each tree outlined in flames. I can tell you that I learned a hell of a lot about forest fires—more than I really wanted to know.

## Once More into the Breach

For a third time that summer in 1987, our home was threatened. The "Hotelling" fire was approaching our cabin from the downriver side. The Forest Service sent the fire crew from the Flathead Fire District in Montana. They arrived out on the road, on the far side of our swinging bridge, delivered by a big yellow school bus.

The Forest Service had commandeered school buses and drivers from Oakland, California. They transported fire crews to and from the many fires burning in our forest. The buses would get the crews and their equipment as close as the roads would allow.

The Flathead crew numbered twenty. They slung on their packs, shouldered their shovels and MacLeods, and crossed the bridge. Our dog, Amelia Airedale, was very excited to see so many people. The crew boss asked me where the fire was and where the available water was. The steepness of the mountain and the density of the forest kept the location of the fire hidden from our view. It had been scouted by plane. I pointed behind the cabin and told him, "Just start up the mountain on that trail. The dog will take off in front of you. Follow her to the end of the water ditch."

## Dog Days

Because we had to clean our water ditch of fallen debris regularly to keep it running, Amelia always thought that

was our destination when climbing the mountain behind our place. The crew took off up the trail, and Amelia took off ahead of them. They spent the day scouting the fire and digging a small reservoir. Amelia spent the whole day with them. During their lunch break, the women on the crew fed her "ham grenades," the fire camp slang for the incredibly dry white bread and ham sandwiches, supplied in the regulation brown bag lunches.

Amelia had never had so many playmates. When the crew came down the trail and crossed our bridge to wait for their bus, I expected Amelia to come home. She didn't. I went across the bridge to see if the crew had seen her. There she was, sleeping on the ground with a dozing firefighter using her as a pillow. I woke her up and took her home.

Every morning, around 8 AM for the next three days, the Flathead crew would arrive by school bus. With Amelia leading the way, they spent their days making a rock dam, lining the reservoir with black plastic, and packing in a small, gas-powered pump and canvas fire hose. That was the extent of what they accomplished before they had to move on to fight other fires. The first morning that they didn't show up, Amelia was heartbroken. She waited on our end of the swinging bridge all day, perking up only when a school bus drove by.

The evening before, on their last trip across the bridge, a tired crewmember lost his footing. He regained his balance, but dropped his shovel into the river. The water was deep under the bridge, about fifteen feet. The crew boss looked down at the shovel through the cold, clear water. "Leave it," he said.

A couple of weeks later, my friend Harry came by. I've known Harry since I was seven years old. He lived upriver at the Lucky Strike mines. Harry brought a big magnet and a light rope. We spent about an hour fishing for that shovel. And, you know, we caught it. I still have that shovel.

## Hosed

Bob-O had been working as a tree faller on a fire crew and was mostly gone. As the danger neared, he stayed home. The Flathead crew had given us the tools to fight the Hotelling fire, but had to move on to other fires, leaving us on our own. With more fire line to be dug and more hose to be laid along the ditch, our friends came to help. Once the fire swept down the mountain to reach us, it would be spread out in a long line against our defenses.

Philbo and Dick Haley from the mining claim a few miles downriver spent all day setting up the pump at the flume reservoir and laying fire hose from there to the dry reservoir by the mine on the other side of our claim. Dick

Haley, who was a veteran of Iwo Jima, had his 70th birthday that day.

Every fifty feet along the main hose was a brass, T-fitting. The Forest Service had left us several shorter lengths (each probably 25 feet) of hose with high-pressure nozzles that would attach to these fittings. The people working the line would carry one of the shorter lengths with a nozzle and attach that to the larger hose closest to a hot spot. After dousing the hot spot, they would unhook their length of hose and continue patrolling the line.

We were as ready as we could be as the fire approached us. During the night, friends took care of the hose lines on the mountain while Bob-O and I tried to sleep. Bob-O had wired a radio speaker into our bedroom so we could hear if they called, needing more help on the hose line.

That evening, he was assuring a friend of ours on the CB that we were all set for when the fire reached us. Another friend, Jeff, came on and told him, "Just remember, if you need us tonight, there are a lot of ears out here listening, and we'll be here for you." So Bob-O said, "Alright all you ears, good night." We heard a woman's voice say, "Good night," then a man's, "Good night," and a man's baritone singing out, "Good night." Altogether, about eight people answered Bob-O's good night with their own.

I felt just about as secure as I could with the fire coming at us. Then that night, someone stole Bob-O's truck from our parking place across the river. (Certainly another story for another time.) Amelia barked in the night to warn us, but with so much fire traffic on the river road, we had quit paying attention.

### **Under Attack**

We were busy the next few days on the mountain behind us, keeping the fire from crossing our lines. I was sitting in the radio shack relaying messages, while Bob-O and some friends were working the pump and fire line behind us. I heard Bob-O gasping for air on the 2-meter radio, which I knew was attached to his belt. I mean, he was really laboring. I was sure he was having an asthma attack.

I tried to call him back, but he wouldn't answer me—then I heard him again. It sounded worse, like he was in acute asthmatic distress. I tried to call his swamper, the guy who carries the faller's gas can and other tools, on the radio because I knew he had a handheld. No dice. I couldn't get anyone on the mountain to answer. I was scrambling for Bob-O's Norepinephrine and hypodermic syringe to take to him, even though I didn't know where on the 1,500 feet of line he was. Then he

called me on his handheld. Calm as you please, "Hi, what's going on?"

Well, it turned out he had been using the hose on a hot spot, and it had so much water pressure that it knocked him down the hill. He had tripped his mike button a couple of times while climbing back up and was breathing hard, fighting his way with the hose. He hadn't heard me call over the noise of the water.

### **Wild Night Life**

My friend Jaycin was sitting outside her house all one night, watching bits of burning trees and brush fall down the steep mountain towards her cabin. If any burning debris got too close, she would shovel dirt on it. The steepness of the Salmon Mountains had hampered the firefighting efforts from the beginning. One firefighter from a southern state was heard to say, "Ya'll got some real pretty country here, but it's a shame somebody has laid it on its side."

Anyway, there she was sitting on a camp chair, wrapped in a sleeping bag, when she heard a noise on the other side of the cabin. So she got up to investigate. As she turned the corner, she came face-to-face with a black bear. They both stopped short, each with a surprised intake of breath, till she uttered a timid, "Hi, there," at which the bear turned to the side and ran off. She stayed and guarded her house from the burning debris for the rest of the night.

Ebb Tide's dog got eaten in her front yard by a mountain lion while she watched, or at least heard—she couldn't look. She was alone there at a cabin on the South Fork with her new little baby son. Her home on the ridge had been burned down in the first days of the fires that summer. Her husband, Rip Tide, like all the local men, was out fighting the fires where he could.

One night, I came across an owl, lost in the smoke. It was still alive, but dazed. I called Bob-O on the radio and he asked, "What do you want to do?" and I said, "Save it." Just about then, a truck came up behind me and a guy jumped out and asked if I needed help. We went to see if we could wrap the owl in a shirt to take it to the fire camp, when it shook its head and flew away. I was mighty relieved.

### **Miner Skirmish**

At one point, the fire boss decided to back burn a huge area of forest, which angered the locals. Don't get me wrong. Back burning can be a valuable tool in fighting wildfires. A back burn is an intentionally set fire that uses up all the fuel in a wildfire's path to create a firebreak. But the whole reason this one was to be so big was because the firefighting personnel didn't know the land in question; so they believed bigger was better.

Local folks protested that this burn was too large and a waste of pristine, unburned forest.

Malfunction Junction, of the Stickel Mines, volunteered to lead the fire crew's Caterpillars through a different route so the back burn could be much, much smaller. I was out on an errand and saw him clinging to the side of a diesel Cat with one hand, cup of coffee clutched in the other. They were just reaching the river road about a half-mile above Matthews Creek. Once again a local fellow had proved his value.

### Containment

One by one, the fires were contained and burned out. It took more than two months for all the fires to end. The rain is what finally ended the fires on the Salmon River. After my work in the radio shack wasn't needed, I went to work at Snipe's Resort (turned into a fire camp) in Cecilville as a "bag lady." I was on a crew of local women who made bag lunches for the fire crews still on the job. I found out why the "ham grenades" were so dry. We could not, by Forest Service regulation, put mayonnaise or mustard on the sandwiches.

I acquired the habit of drinking coffee (I had been a tea drinker). Not only that, but I would mix a package of hot chocolate mix into the coffee for an extra kick of energy (and flavor). It was a trick Philbo taught us. It makes even a lowly cup of fire camp coffee drinkable. I have to admit I still do it at times.

Everyone we knew was either threatened by or outright burned out by a fire that autumn of 1987. I learned a hell of a lot about forest fires that year. But I also learned a lot about the people in the community where I lived. And that knowledge comforted me.

### Access

Kathleen Jarschke-Schultze is attempting to make mead at her home in Northernmost California. c/o *Home Power* magazine, PO Box 520, Ashland, OR 97520 • kathleen.jarschke-schultze@homepower.com



**SUNELCO**  
THE SUN ELECTRIC COMPANY  
[www.sunelco.com](http://www.sunelco.com) • 800-338-6844

## Intentional *Communities*



Dedicated to communicating the experience and wisdom of intentional community.

We've been at it for 30 years, and nobody covers the world of community like *Communities* magazine.

1 year subscription \$20 (\$24 Canada)

Sample issue \$6 (\$8)

800-462-8240

[fic.ic.org/cmaga](http://fic.ic.org/cmaga)

## WE WROTE THE BOOK ON ELECTRIC CAR CONVERSIONS

### **CONVERT IT** How-To Manual by Michael Brown with Shari Prange

Expanded & Updated 3rd Edition  
\$30.00 tax & postage included

*"We built Mr. Brown's car, and we won."*

Bruce Burk, St. Johnsbury Academy,  
1991 American Tour de Sol Open Class Winner.



**ELECTRO AUTOMOTIVE**  
POB 1113-HP, FELTON, CA 95018



[www.electroauto.com](http://www.electroauto.com)

# How much energy does it use?

A perfect "first step" in your switch to renewable energy



## Kill A Watt

Electricity Usage Meter

Large LCD displays: kWh (cumulative over time), Watts, VA, Volts, Current, Frequency, Power Factor, Timer

Things that Work!  
HP 90, pg 116  
HP Readers' Special:  
**\$35**  
+ \$5.00 for S&H

**EcoLogics**  
INTELLIGENT ENERGY AND TRANSPORTATION

Call Toll Free:  
1.866.SOLAR EV (765-2738)  
e-mail: info@noemissions.com  
www.noemissions.com



We specialize in photovoltaics—  
please call for current specials on  
Siemens/Shell SP75 and SP130 modules.

# RENEWABLE ENERGY SOLUTIONS!

**WIND POWER**

**PHOTOVOLTAIC**

**MICROHYDRO**



**HUMAN POWER GENERATOR**

**WINDSTREAM POWER SYSTEMS INC.**

PO Box 1604 HP, Burlington, VT 05402 Tel 802 658 0075 Fax 802 658 1098  
info@windstreampower.com • www.windstreampower.com  
Independent Power Systems Throughout the World – Our 26th Year

## SOLAR COOLING

WITH

**SOLAR CHILL**

ULTRA LOW ENERGY – 25 TO 130 WATTS!

The most efficient coolers on the planet.

12 & 24 Volt DC Evaporative Coolers

KAR KOOL FOR YOUR VEHICLE

Call **SOUTHWEST SOLAR**  
(520) 885-7925 Tucson,  
Arizona, USA  
southwest-solar.com



## QUICKCHARGER

"C. Crane's QuickCharger is the best battery charger I've ever used."

— Richard Perez, Things That Work!, Home Power #86



- Recharges Up To 4 AAA, AA, C And D Size NiCad And NiMH Batteries

- The Only Charger To Fully Charge All Sizes Of New High Capacity NiMH And NiCad Batteries

- Intelligent Discharge Revitalizes NiCad Batteries

- Also Works On 12 Volt

Call for  
FREE #14  
Catalog

**C. CRANE COMPANY**

**\$39<sup>95</sup> SALE**  
**\$49<sup>95</sup>**  
FREE US Shipping

800-522-8863 • ccrane.com

## Solar Pathfinder

The Best Tool For Solar Site Analysis

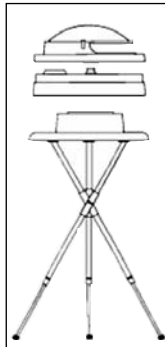

- \* Easy to Use
- \* Fast & Accurate
- \* Diagrams from 0–66° N & 0–49° S
- \* Pathfinder with metal case & tripod \$255, Handheld \$175 (+ shipping)

3680 Hwy 438, Dept HP  
Pleasantville, TN 37147  
Phone & Fax 931-593-3552  
www.solarpathfinder.com



## Earn a degree in Renewable Energy

with a concentration in Photovoltaic Design and Installation



**SAN JUAN COLLEGE, FARMINGTON, NM**

Two-year AAS degree or one-year certificate.

Both emphasize full NEC compliance.

Combine science with hands-on learning.

Tuition \$300/semester out-of-state and \$180 in-state.

Carl Bickford, (505) 566-3503 or (800) 241-6327  
bickfordc@sanjuancollege.edu

www.sanjuancollege.edu/academics/technology/RENG/index.htm

# HAPPENINGS

Send your renewable energy event info to [happs@homepower.com](mailto:happs@homepower.com)

## INTERNATIONAL

Free instructions, photos, drawings, & specs to build solar cookers & water systems with local materials, purchased with local currency. Sunstove • [www.sungravity.com](http://www.sungravity.com)

El Paso Solar Energy Association bilingual Web site. Info en Español on energy & energy saving. Free download of PV Systems book. [www.epsea.org/esp](http://www.epsea.org/esp)

Green Empowerment finances microhydro & other RE projects in Nicaragua, the Philippines, & Borneo. Volunteers needed. [www.greenempowerment.org](http://www.greenempowerment.org)

Solar On-Line (Sól) Internet courses. Year-round. PV Technology & Opportunities: A Qualitative Overview; PV Systems Design: Basic Course; PV Systems Design: Professional Course; Hands-On PV System Installation; Solar Homes; Healthy Buildings; & Solar Energy for International Development. Sól, PO Box 217, Carbondale, CO 81623 720-489-3798 • [info@solenergy.org](mailto:info@solenergy.org) [www.solenergy.org](http://www.solenergy.org)

## BRAZIL

May 15–17, '03; REsolutions South America, São Paulo. Trade show & conference. Info: +55 11 3873-7614 • [info@wbe.com.br](mailto:info@wbe.com.br)

## CANADA

Jun. 7, '03; 8th Annual EV Show; Vancouver. Info: [www.veva.bc.ca](http://www.veva.bc.ca)

Jun. 8–13, '03; Hydrogen & Fuel Cells '03. Vancouver. Info: 1444 Alberni St. #101, Vancouver, BC V6G 2Z4 800-555-1099 or 604-688-9655 [hfc2003@advance-group.com](mailto:hfc2003@advance-group.com) [www.hydrogenfuelcells2003.com](http://www.hydrogenfuelcells2003.com)

Alberta Sustainable House; open house 3rd & 4th Saturdays, 1–4 pm. Cold-climate features & products for health, environment, conservation, RE, recycling, efficiency, self-sufficiency, appropriate technology, autonomous & sustainable housing. Free. 9211 Scurfield Dr. NW, Calgary, AB T3L 1V9 Canada • 403-239-1882 • [jdo@ucalgary.ca](mailto:jdo@ucalgary.ca)

Vancouver Electric Vehicle Association. Call for meeting info. PO Box 3456, 349 West Georgia, Vancouver, BC V6B 3Y4 Canada 604-878-9500 • [info@veva.bc.ca](mailto:info@veva.bc.ca) [www.veva.bc.ca](http://www.veva.bc.ca)

## CUBA

May 3–12, '03; Havana, Cuba. XIX Latin American Conference on Rural Electrification: For a Cleaner Future. RE, networking, equipment & technology fair, & site visits. Rachel Bruhnke, Global Exchange, 2017 Mission St. #303, San Francisco, CA 94708 415-575-5531 • [rachel@globalexchange.org](mailto:rachel@globalexchange.org) [www.solarenergy.org/Cuba\\_conf.html](http://www.solarenergy.org/Cuba_conf.html)

## GERMANY

Apr. 7–12, '03; World Fair for Energy Management, Energy Technology & RE; Hannover. International focus on the future of energy. Info: [www.hannovermesse.de](http://www.hannovermesse.de)

Oct. 9–11, '03; Hydrogen Expo, Hamburg. Exhibits, technology, & commercialization. Info: Hamburg Messe, + 49-211-687858-11 [info@h2expo.de](mailto:info@h2expo.de)

## ITALY

Apr. 10–12, '03; EOLICA EXPO, Naples. Wind energy exhibition. Solar Energy Group Srl, Via Gramsci, 63-20032 Cormano, MI (Italy) 02-66301754 • [info@eolicaexpo.com](mailto:info@eolicaexpo.com) [www.eolicaexpo.com](http://www.eolicaexpo.com)

## MEXICO

May 5–11, '03; PV for Rural Development. Oaxaca. Hands-on PV installation & design for home lighting, water pumping, classroom, office, & communications. Info: see Solar On-Line in INTERNATIONAL

May 13–17, '03. Solar Energy for Rural Development: Food and Water. Oaxaca. Hands-on installation & design for ecological systems for food and water. Solar cookers, dryers, fuel efficient wood stoves, water pumping & purification, & water heating. Info: see Solar On-Line in INTERNATIONAL

## NICARAGUA

Aug. 5–15, '03 (again Jan. 6–16, '04); Solar/Cultural Course. Managua. Lectures, field experience, & eco-tourism. Taught in English by Richard Komp & Susan Kinne. Info: Barbara Atkinson, 215-942-0184 [lightstream@igc.org](mailto:lightstream@igc.org) [www.grupofenix-solar.org](http://www.grupofenix-solar.org)

## SINGAPORE

Nov. 18–19, '03; Sustainable Energy Asia, & Energy Efficiency Asia. Conference. Info: Christina English • (65) 6227 6252 [cenglish@iirx.com.sg](mailto:cenglish@iirx.com.sg)

## SWEDEN

Jun. 14–19 '03; ISES Solar World. Göteborg, Sweden. Scientific technical RE conference. Congrex Göteborg AB, PO Box 5078, 402 22 Göteborg, Sweden • +46 31 81 82 20 [ises2003@gbg.congrex.se](mailto:ises2003@gbg.congrex.se) [www.congrex.com/ises2003](http://www.congrex.com/ises2003)

## VIRGIN ISLANDS

Apr. 28–May 9, '03; PV Design & Installation workshop; St. John. See COLORADO for SEI contact info.

## WALES

May 23–25, '03; Intro to RE course, Univ. of Wales, Aberystwyth. RE technology, incl. solar, wind, & hydro. Green Dragon Energy, 01974 821 564 • [dragonrg@talk21.com](mailto:dragonrg@talk21.com) [www.greendragonenergy.co.uk](http://www.greendragonenergy.co.uk)

## NATIONAL U.S.

Apr. 30, '03; Solar Decathlon 2005 proposals due date. For info & request for proposal: [www.solardecathlon.org](http://www.solardecathlon.org)

Ham HF net. Amateur radio operators involved with RE & interested in an informal net, please contact Craig Miller, W8CR, 4085 Home Rd., Powell OH 43065 • [w8cr@qsl.net](mailto:w8cr@qsl.net)

Pollution prevention videos. Appalachia: Science in the Public Interest offers 42 videos, incl. Solar Dry Composting Toilets, Solar Hot Water Systems, PV, Solar Space Heating, Solar-Powered Automobiles, Quilted Insulated Window Shades, & more. Broadcast-quality tapes available. ASPI Publications, 50 Lair St., Mt. Vernon, KY 40456 • 606-256-0077 [aspi@kih.net](mailto:aspi@kih.net) • [www.kih.net/aspi](http://www.kih.net/aspi)

American Wind Energy Assoc. Info about U.S. wind industry, membership, small turbine use, & more. [www.awea.org](http://www.awea.org)

State & Fed. incentives for RE info. North Carolina Solar Center, Box 7401 NCSU, Raleigh, NC 27695 • 919-515-3480 [www.dsireusa.org](http://www.dsireusa.org)

Energy Efficiency & Renewable Energy Clearinghouse (EREC): Insulation Basics (FS142), New Earth-Sheltered Houses (FS120), PV: Basic Design Principles & Components (FS231), Cooling Your Home Naturally (FS186), Automatic & Programmable Thermostats (FS215), & Small Wind Energy Systems for the Homeowner (FS135). EREC, PO Box 3048, Merrifield, VA 22116 • 800-363-3732 • TTY: 800-273-2957 [energyinfo@delphi.com](mailto:energyinfo@delphi.com) • [www.eren.doe.gov](http://www.eren.doe.gov)

Ask an Energy Expert: online questions to specialists. Energy Efficiency & Renewable Energy Network (EREN) • 800-363-3732 [www.eren.doe.gov](http://www.eren.doe.gov)

National Wind Technology Center. Assists wind turbine designers & manufacturers with development & fine tuning. Golden, CO 303-384-6900

Stand-Alone PV Systems Web site: design practices, PV safety, technical briefs, battery & inverter testing. Sandia Labs, [www.sandia.gov/pv](http://www.sandia.gov/pv)



Federal Trade Commission free pamphlets: Buying an Energy-Smart Appliance, Energy Guide to Major Home Appliances, & Energy Guide to Home Heating & Cooling. Energy Guide, FTC, Rm. 130, 6th St. & Pennsylvania Ave. NW, Washington, DC 20580 • 202-326-2222 • TTY: 202-326-2502 • www.ftc.gov

Solar Curriculum for schools. 6 week science curriculum or individual sessions. Free! 30 classroom presentations & demos using free or low-cost materials. Susan Schleith, Florida Solar Energy Center • 321-638-1017 www.fsec.ucf.edu

## ARIZONA

Apr. 12, '03; 21st Annual Tucson Solar Potluck & Exhibition; Catalina State Park, Tucson. Bring solar ovens &/or a dish to share. Music, solar cooked samples, camping. Info: Bill Cunningham • 520-885-7925 cuningham@dakotacom.net

Aug. 8–10, '03; SW RE Fair; Flagstaff. Expo, workshops, seminars, demonstrations, tours, keynote, kids' fair, & more. Info: GFEC www.gfec.org/SWREF

Tax credits for solar in AZ. ARI SEIA 602-258-3422

Scottsdale, AZ. Living with the Sun; free lecture series, 3rd Thurs. each month, 7–9 PM, City of Scottsdale Urban Design Studio. History & current concepts, design, applications, solar heating & cooling, architecture, landscaping, PV, & cooking. Dan Aiello • 602-952-8192; or AZ Solar Center www.azsolarcenter.org

## CALIFORNIA

Oct. 1–3, '03; Sustainable Energy Expo & Conference; Los Angeles Convention Center. Business conference & trade show. John Mikstay • 646-432-1102 www.sustainableexpo.com

Nov. 15–19, '03; EVS 20, International EV Symposium & Expo; Long Beach. Info: www.evs20.org

Arcata, CA. Campus Center for Appropriate Technology, Humboldt State Univ. workshops. & presentations on alternative, renewable, & sustainable living. CCAAT, HSU, Arcata, CA 95521 • 707-826-3551 ccaat@axe.humboldt.edu www.humboldt.edu/~ccaat

Rebates for PV & wind. CA Emerging Renewables Buydown Program, CA Energy Comm. • 800-555-7794 or 916-654-4058 renewable@energy.ca.gov www.consumerenergycenter.org/buydown

Energy Efficiency Building Standards for CA. CA Energy Comm. • 800-772-3300 www.energy.ca.gov/title24

Solar e-Clips, free weekly e-mail newsletter. CA news & info solar energy. Subscribe: www.californiasolarcenter.org

Solar Living Institute workshops. Advanced PV Design & Installation for Off-grid Systems, Bio-intensive Food Production, Composting Toilets & Greywater Systems, EVs, Grid-tied Solar Electric Systems & Money Saving Rebates, Hybrid Adobe, Hydrogen-the Emerging Fuel Source, Intro to Permaculture, Intro to PV, Natural Building Workshop, PV Design & Installation for Off-grid Systems, Solar Installer Training, Straw Bale Construction, & The Green Householder. Info: Solar Living Institute, PO Box 836, Hopland, CA 95449 • 707-744-2017 sli@solarliving.org • www.solarliving.org

## COLORADO

Apr. 12, '03; Solar Thermal Workshop & COSEIA certification test; Boulder. Info: COSEIA • 303-333-7342 or 866-633-9764 info@coseia.org • www.coseia.org

June 27–29, '03; 6th Annual Colorado Renewable Energy Conference—Renewable Energy Now! Montrose, CO. Workshops, energy policy, rural power, building, education, guest speaker. Info: Colorado Renewable Energy Society, 303-806-5317 info@cres-energy.org • www.cres-energy.org

Aug. 4–8, '03; RE Youth Camp; Paonia, CO. Ages 15–19. See below for SEI contact info.

Carbondale, CO. SEI hands-on workshops & online distance courses. PV Design & Installation, Advanced PV, Solar Water Pumping, Wind Power, Micro-hydro, Solar Hot Water, Biodiesel, Alternative Fuels, Solar Home & Natural House Building, Advanced Straw Bale Construction, RE for the Developing World, Politics of Energy, Utility Interactive PV, Women's PV Design & Installation, Women's Wind Power, Women's Carpentry, PV Distance course, & Solar Home Design distance course. Solar Energy International (SEI), PO Box 715, Carbondale, CO 81623 • 970-963-8855 sei@solarenergy.org • www.solarenergy.org

## ILLINOIS

Aug. 9–10, '03; 2nd Illinois RE Fair; Ogle County Fairgrounds, Oregon, IL. Info: 815-732-7332 • sonia@essex1.com www.illinoisrenew.org

## IOWA

Prairiewoods & Cedar Rapids, IA. Iowa RE Assoc. meets 2nd Sat. every month at 9 AM. Call for changes. IRENEW, PO Box 355, Muscatine, IA 52761 • 563-288-2552 irenew@irenew.org • www.irenew.org

## KENTUCKY

May 31 & June 1; Solar Hot Water Design & Installation workshop. Mt. Vernon, KY. Appalachia; Science in the Public Interest. Projects & demos in gardening, solar water heating, solar-electric, sustainable forestry, more. ASPI, 50 Lair St., Mt. Vernon, KY 40456. 606-256-0077 solar@a-spe.org • www.a-spi.org

## MAINE

Apr. & May, '03; Intro. to Solar Electricity. Grid-tie & Stand Alone systems, incl. design, site evaluation, & components. Times & dates TBA. Free. Info: Solarwinds NorthernLights 207-832-7574 • tump@midcoast.com or paul.morrissey@state.me.us www.solarwindsnorthernlights.com

## MARYLAND

Apr. 1, '03 (starts Mar. 30); National Green Building Conference; Baltimore. Tours, exhibits, awards, networking, & education on design & construction, energy efficiency, air quality, financing, marketing & more. Info: 888-602-4663 • kvictorio@nahbrc.org www.nahbrc.org/ngbc

## MASSACHUSETTS

Greenfield Energy Park. Ongoing energy demos & exhibits. NESEA, 50 Miles St., Greenfield, MA 01301 • 413-774-6051 nhazard@nesea.org • www.nesea.org

## MICHIGAN

Urban Enviro workshop, Ferndale, MI. 2nd & 4th Thurs. 7–9 PM. Sustainability, energy efficiency, RE, & consumer issues. Free. Mike Cohn, 22757 Woodward #210, Ferndale, MI 48220 • 313-218-1628 ECadvocate@aol.com www.hometown.aol.com/ecadvocate

Intro to Solar, Wind, & Hydro. West Branch, MI. First Fri. each month. System design & layout for homes or cabins. Info: 989-685-3527 • gotter@m33access.com

## MINNESOTA

Apr. 11–12, '03; 2003 Living Green Expo; Minnesota State Fairgrounds, St. Paul. Includes RE, energy efficiency, clean transportation, hybrid vehicle, wind turbines, & workshops. Info: Minn. Dept. of Commerce, State Energy Office • 612-331-1099 or 651-215-0218 • mike.taylor@state.mn.us www.livinggreenexpo.org

## MONTANA

Jul. 12, '03; Sustainability Fair 2003; Depot Rotary Park, Livingston. Exhibitors, workshops, on-site "sustainable office," RE, music, kids' programs, & green products. Info: Corporation for the Northern Rockies 406-222-0730 • info@northrock.org www.northrock.org

Aug. 18–22, '03; Biodiesel Fuel; Missoula, MT. Make biodiesel & a biodiesel processor. Vehicle conversion & straight vegetable oil covered. Info: see SEI in COLORADO listings. Local Coordinator: David Max zenfuel@yahoo.com

Whitehall, MT. Sage Mountain Center: one-day seminars & workshops, inexpensive sustainable home building, straw bale constr., log furniture, cordwood constr., PV, more. SMC, 79 Sage Mountain Trail, Whitehall, MT 59759 • 406-494-9875 cborton@sagemountain.org

## Happenings

### NEW MEXICO

May 16–17, '03; Solar Radiant Heating Seminar & Workshop; Albuquerque. One or both days. Info: USA Solar, 125 Mountain Shadows Dr. Sedona, AZ 86336  
928-282-5140 • peter.biondo@usasolar.net  
www.usasolar.net

Sep. 29–Oct. 3, '03; Natural House Building workshop; Kingston, NM. Build with earth & straw. Hands-on sessions: straw bale, adobe, pressed block, rammed earth, cob, & natural plaster. Info: see SEI in COLORADO listings.

### NEW YORK

Apr. 21–26, '03; PV Design & Installation workshop; Woodstock. See COLORADO for SEI contact info.

RE Loan fund: low interest financing: NY Energy Smart Program, NY State Energy R&D Authority • 518-862-1090 ext. 3315  
rgw@nyserda.org • www.nyserda.org

### NORTH CAROLINA

Apr. '03; Appalachian State Univ. Solar Energy Society workshops. 7 PM Kerr Scott Hall auditorium. Apr. 7: Sustainable Transportation, Apr. 14: Wind Power Production, Apr. 28: RE in Watauga County. Free. Info: Alex Glenn, 828-263-8363 • www.asuses.org

Saxapahaw, NC. How to Get Your Solar-Powered Home. Seminars 1st Sat. each month. Solar Village Institute, PO Box 14, Saxapahaw, NC 27340 • 336-376-9530  
solarvil@netpath.net

### OHIO

May 5–9, '03; Biodiesel Fuel workshop; Cleveland. See COLORADO for SEI contact info. Local Coordinator: Matt Harris  
onelove25@surf.net

### OKLAHOMA

Jun. 19, '03; 2003 Oklahoma Wind Power & Bioenergy Conf.; Norman, OK. Utility scale wind, small wind, bioenergy, & business. Info: OK Wind Power Initiative • 405-447-8412  
windgirl@ou.edu • www.seic.okstate.edu/owpi

### OREGON

EORenew Workshops. Apr. 5–6: Building a Mobile Solar Water Pumper, Prineville; Jul. 21–24: Pre-SolWest hands-on solar installation class, John Day. See below for SolWest info.

Apr. 26, '03; Umpqua Community College's Alternative Energy Fair with Douglas County Earth Day Celebration; Douglas County Fairgrounds, Roseburg, OR. Richard Perez, keynote speaker. Info: 541-440-4601  
bonniej@mcsi.net

Jul. 25–27, '03; SolWest Renewable Energy Fair, John Day, OR. EORenew, PO Box 485, Canyon City, OR 97820 • 541-575-3633  
info@solwest.org • www.solwest.org

Cottage Grove, OR. Adv. Studies in Appropriate Tech., 8 weeks, 4 interns per quarter. Aprovecho Research Center, 80574 Haxelton Rd., Cottage Grove, OR 97424  
541-942-0302 • apro@efn.org  
www.efn.org/~apro

### PENNSYLVANIA

Penn. Solar Energy Assoc. meeting info: PO Box 42400, Philadelphia, PA 19101  
610-667-0412 • rose-bryant@erols.com

PV grants for Penn. available through the Sustainable Development Fund  
sdf@trfund.com • www.trfund.com/sdf

Philadelphia Million Solar Roofs Partnership  
215-988-0929 ext. 242  
hannahl@ecasavesenergy.org  
www.phillysolar.org

### RHODE ISLAND

Energy Co-op provides RE, energy efficiency & conservation services, & group purchases of EnergyStar products. Erich Stephens  
401-487-3320 • erich@sventures.com

### TENNESSEE

Apr. 14–19, '03; PV Design & Installation workshop; Summertown. See COLORADO for SEI contact info.

Summertown, TN. Kids to the Country: nature study program for at-risk urban TN children. Sponsors & volunteers welcome. The Farm, Summertown, TN 38483 • 931-964-4391  
ktcfarm@usit.net

### TEXAS

Jun. 21–26, '03; SOLAR 2003, Austin. Annual American Solar Energy Society conference. ASES, 2400 Central Ave. #G-1, Boulder, CO 80301 • 303-443-3130 • ases@ases.org  
www.ases.org

El Paso Solar Energy Assoc. meets 1st Thur. each month. EPSEA, PO Box 26384, El Paso, TX 79926 • 915-772-7657 • epsea@txses.org  
www.epsea.org

Houston Renewable Energy Group: meets last Sun. of Jan., Apr., July, Oct. & occasional extra meetings at TX State Univ. Engineering Building, 2 PM. Info: HREG, hreg@swbell.net  
www.txses.org/hreg/

### VERMONT

Jul. 12–13, '03; SolarFest RE festival; Green Mt. College, Poultney, VT. Solar stages, workshops, vendors. Info: 802-235-2866 • www.solarfest.org

### VIRGINIA

Info & services on practical solar energy apps in VA. VA Solar Energy Assoc., the VA Solar Council, & the VA SEIA. Info: VA Div. of Energy • 804-692-3218

### WASHINGTON STATE

Apr. 5, '03; Intro to RE workshop, Guemes Island, WA. Intro to solar, wind, & microhydro for homes. Lecture and tours. Info: see SEI in COLORADO listings. Local coordinator: Ian Woofenden • 360-293-7448  
ian.woofenden@homepower.com

Apr. 7–12, '03; Solar-Electric (PV) Design & Installation workshop. Guemes Island, WA. System design, components, site analysis, system sizing, & hands-on installation. Info: see SEI in COLORADO listings. Local coordinator: Ian Woofenden • 360-293-7448  
ian.woofenden@homepower.com

Apr. 14–19, '03; Homebuilt Wind Generators with Hugh Piggott; Guemes Island, WA. Learn to build wind generators from scratch, blade carving, winding alternators, assembly, & testing. Info: see SEI in COLORADO listings. Local coordinator: Ian Woofenden  
360-293-7448  
ian.woofenden@homepower.com

Apr. 21–24, '03; Microhydro-Electric Systems workshop. Guemes Island, WA. Lectures, labs, systems tours, & a tour of Canyon Industries. Info: see SEI in COLORADO listings. Local coordinator: Ian Woofenden  
360-293-7448 •  
ian.woofenden@homepower.com

### WISCONSIN

June 20–22, '03; RE & Sustainable Living Fair (a.k.a. MREF); Custer, WI. Exhibits, workshops on solar, wind, water, green building, alternative fuels, organic gardening, energy efficiency, & healthy living. Home tours, silent auction, Kids' Korral, entertainment, keynote speaker. See below for MREA access.

MREA workshops: Women's Wind Power: Jun. 8–14 in Custer; Solar Space Heating, Wind System Install, PV Installs, Straw Bale, Masonry Heaters, Sustainable Living. MREA, 7558 Deer Rd., Custer, WI 54423 • 715-592-6595 • mreainfo@wi-net.com  
www.the-mrea.org

### ENERGY FAIRS

See: www.homepower.com



# ZAPSUCKER .COM



# Writing for Home Power Magazine

**H**ome Power is a user's technical journal. We specialize in hands-on, practical information about small-scale renewable energy systems. We try to present technical material in an easy to understand and easy to use format. Here are some guidelines for getting your renewable energy (RE) experiences printed in *Home Power*.

## Informational Content

Please include all the details! Be specific! We are more interested in specific information than in general information. Write from your direct experience—*Home Power* is hands-on! Articles must be detailed enough that our readers can actually use the information. Name names, and give us actual numbers, product names, and sources.

If you are writing about someone else's system or project, we require a written release from the owner or other principal before we can consider printing the article.

## Article Style & Length

*Home Power* articles can be between 350 and 3,000 words. Length depends on what you have to say. Say it in as few words as possible.

We prefer simple declarative sentences that are short (fewer than twenty words) and to the point. We like the generous use of subheadings to organize the information. We highly recommend writing from within an outline. Check out articles printed in *Home Power*. After you've studied a few, you will get a feeling for our style.

We edit all articles for accuracy, length, content, organization, and basic English. You can help by keeping your sentences short, simple, and to the point. Our editing crew will make your text shine.

## Photographs

We can work from good photographic prints, slides, or negatives. We prefer 4 by 6 inch color prints with no fingerprints or scratches. Do not write on the back of your photographs, since the ink can transfer to the front of the next photo. Please provide a comprehensive caption and photo credit for each photo. Include some vertical format photos—you might even find your system on *HP's* cover. People are nice in photos; a fuse box is only so interesting, even to solar nerds.

Digital photos should be at least 280 pixels per inch (ppi) at the final printed size. This means that a column width photo should be 1,000 pixels wide or more. A full page width photo should be at least 2,300 pixels wide. Basically, set your

digital camera at its highest resolution, and crop thoughtfully. We prefer Photoshop files, but we can handle the following formats in descending order of preference—EPS, TIFF, and JPEG.

## Art, Schematics, & Tables

System articles must contain a schematic drawing showing all wiring. Our art department can make gorgeous diagrams, charts, and schematics from your rough sketches. If you want to submit a computer file of a schematic or other line art, please call or e-mail us first.

For system articles, we require a load table listing all loads, with wattage and run time. We also require an itemized cost table listing each system component and its cost. We prefer to have the tables come to us in Excel format. But we can use them from any word processor or spreadsheet format if they are saved as "text only," with tabs as the delimiter between data.

## Computer Talk

We can take text from most word processors. Save all word processor files in "TEXT" or "ASCII TEXT" format. This means removing all word processor formatting and graphics. Use the "Save As Text" option in your word processor.

If you want to send files larger than 5 MB (such as digital photos), use removable media and snail mail it to us. We can read ZIP disks (either Mac or IBM) and CD-ROMs. You can also FTP your large files to us at [ftp.homepower.com](http://ftp.homepower.com), to the "incoming" folder. Please e-mail us after you have sent files via FTP.

## Putting It All Together

We get many more articles submitted than we can print. The most useful, specific, organized, and complete get published first. Here are the basic components of a great *Home Power* article:

- Clearly written, well organized, and complete text, with a strong introductory paragraph, subheads for each major section, and a strong closing paragraph.
- Photos (plenty) with comprehensive captions.
- Cost table.
- Load table.
- Other tables, charts, and diagrams as appropriate.
- System schematic.
- Complete access information for author, installers, consultants, suppliers, and manufacturers.

Have any questions? Give us a call Monday through Friday from 9 to 5 Pacific and ask. Or send e-mail. This saves everyone's time. We hope to see your RE project in *Home Power* soon!

## Access

*Home Power* magazine, PO Box 520, Ashland, OR 97520  
USA • [submissions@homepower.com](mailto:submissions@homepower.com)  
[www.homepower.com](http://www.homepower.com) For FedEx, UPS or other shipping  
only (no postal service): 312 N. Main St., Phoenix, OR  
97535 • 541-512-0201





# the Wizard speaks...

## Potential Results

The most promising fields of physics today are those concerned with the understanding and manipulation of the fields inherent in the apparent vacuum of space. Other important fields are those concerned with the esoteric properties of angular momentum, and those exploring leading edge ideas in electricity and magnetism. Success in some or all of these endeavors will fall into three categories.

The first category contains the most likely results. These are "free energy" and antigravity. The second category consists of a variety of possible results. These could include faster-than-light communication and travel, and direct matter transmission. The final category could contain such outcomes as interdimensional travel.

I realize that this all sounds like science fiction. We must remember, however, that science fiction was on the moon long before we were, and has predicted many of our modern-day miracles. Just the study of these possibilities could produce spin-offs with positive economic, social, and environmental benefits. Total success would surely bring its own problems, but it would also greatly expand the possibilities.

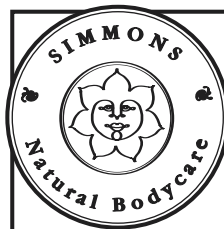

### Make every day special

The natural ingredients of our products get their energy from the sun



Off the grid since 1980

[simmonsnaturals.com](http://simmonsnaturals.com)  
42295 Hwy. 36, Bridgeville, Ca 95526



## Adopt a Library!

When Karen and I were living with kerosene lamps, we went to our local public library to find out if there was a better way to light up our nights. We found nothing about small scale renewable energy.

One of the first things we did when we started publishing this magazine thirteen years ago was to give a subscription to our local public library.

You may want to do the same for your local public library. We'll split the cost (50/50) of the sub with you if you do. You pay \$11.25 and Home Power will pay the rest. If your public library is outside of the USA, then we'll split the sub to your location so call for rates.

Please check with your public library before sending them a sub. Some rural libraries may not have space, so check with your librarian before adopting your local public library. Sorry, but libraries which restrict access are not eligible for this Adopt a Library deal—the library must give free public access. — Richard Perez

To Adopt a Library write or call

**Home Power®**

PO Box 520, Ashland, OR 97520 USA  
1-800-707-6585 or 541-512-0201 or FAX 541-512-0343  
[hp@homepower.com](http://hp@homepower.com) • [www.homepower.com](http://www.homepower.com)

# Amazon Power Company

Photovoltaic Systems  
for Home, Water pumping, & RVs

System Design, Sales,  
& Installation

Donna Fischer  
Amazon Power Company  
RR 1, Box 1, Embudo, NM 87531  
**505-579-4089**

New Mexico Electrical Contractor Lic. # 80290

# GREAT NORTHERN SOLAR

Waking Up  
the Northland to  
Renewable Energy &  
Sustainable Living!

Bringing the finest in technology, equipment, and  
knowledge to the northern midwest.

Solarex & Kyocera photovoltaic modules  
Trace & Heart inverters  
controllers, meters & more!

**Great Northern Solar**



77450 Evergreen Road, Suite #1, Port Wing, WI 54865  
(715) 774-3374 • gosolar@win.bright.net

## Get A Job!

**Home Power is proud to offer a new feature on our Web site called "Get a Job!"**

**Home Power encourages businesses to post their renewable energy related jobs on our Web site at no charge.**

**If you want to work in the RE industry, you can search the listings for your dream job.**

**Make your work part of the solution!**

**www.homepower.com**

## Solar pumping?

The Alternative Technology Association (Australia) now has a new version of our popular build-your-own Mini-maximiser kit.

This clever device allows loads such as pumps and motors to be driven directly from one or more solar panels without the need for batteries. The maximiser allows the solar panel to provide the maximum power to the load, and can provide up to 40% more water pumping per day from the same solar panel. While not a MPPT device, it will work almost as well for far less cost.

The kit comes standard as a 12 volt model capable of handling up to an 85 watt solar panel (or two 85 watt panels for the 24 volt version). Remember to state which voltage you require when ordering.

The new kit features an easy to solder circuit board, and we supply the kit with a 6 amp diode and 60 amp MOSFET. Kit includes circuit board, all components and instructions. No case is provided.

To order your Mini-maximiser via credit card (Bankcard, Visa or Mastercards only), go to our web site at [www.ata.org.au](http://www.ata.org.au), email [ata@ata.org.au](mailto:ata@ata.org.au) or fax your credit card details to: +61 3 9388 9322. Note: orders will be charged in Australian dollars, so actual cost in US dollars will vary with exchange rates.



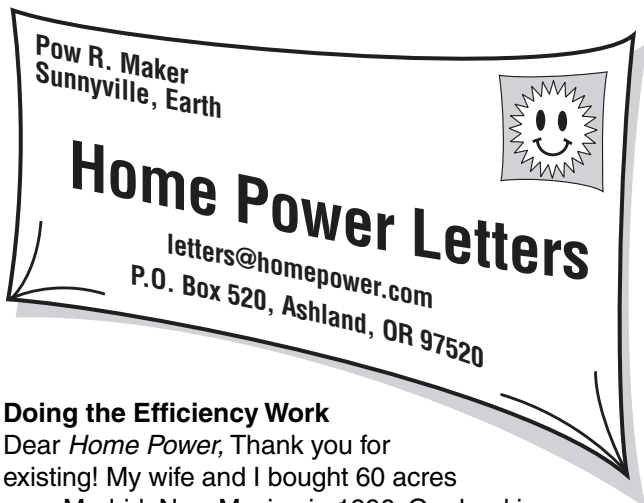

**Doing the Efficiency Work**

Dear *Home Power*, Thank you for existing! My wife and I bought 60 acres near Madrid, New Mexico in 1996. Our land is completely off-grid—no electricity, no gas, no anything. At that time we had only the vaguest idea about renewable energy. Shortly after purchasing that land, a friend turned us on to *HP*. We have read every issue since.

The magazine has given us a broad education in both renewable energy and energy conservation. With the help of a local off-grid designer, we are currently designing our future house and energy system.

However, we are still in our house in Albuquerque. Though we have not made our city house as efficient as possible, we have listened to *HP's* words. We have taken three steps to conserve:

1. We have changed almost all our incandescent lights to compact fluorescents. When we started that process back in 1996, compact fluorescents were expensive, so large that they didn't fit many fixtures, and hard to find. Today, we buy five-packs of conveniently sized compact fluorescents at Costco.
2. We replaced our refrigerator with a newer model.
3. We became more aware of our energy usage and cut back or simply turn off a light or appliance where we can.

I did a quick analysis of our energy usage over the last three years and was delighted to find a downward trend. We can still do more and we will, but we were gratified to see our investment in buying *Home Power* magazine is already paying off. Grey & Michele Chisholm, Albuquerque, New Mexico • GreyChis@who.net

**Phantom Loads Not Welcome**

Mainstream media may just be awakening to the issue of phantom loads.

*Discover* magazine's Dec '02 issue provided a breakdown of estimated U.S. phantom load energy consumption, indicating a total of 71 terawatt-hours (TWH) consumed by electrical devices while switched off. [Ed. note: *tera* = trillion]

Home Office:	44% (31 TWH/year)
Telephony:	8% (5.5 TWH/year)
Cable Boxes:	7% (5 TWH/year)
Audio:	19% (13.5 TWH/year)
VCR/DVD:	12% (8.5 TWH/year)
TV:	10% (7 TWH/year)

A few more interesting statistics from the *Discover* magazine article, written by Rachael Moeller Gorman: 6% of all U.S. electrical energy is wasted powering electrical devices that are "off." Since most devices are off more often than they are on, even though their "off" mode draws considerably less than their "on" mode, many devices use more energy sleeping (time off x phantom load drain) than they use while serving us (time on x real power draw). Relatively infrequently used devices such as VCRs and DVDs use more than 90 percent of their total energy usage while they are switched off!

The Lawrence Berkeley National Laboratory Web site provides a rather brief list of devices that they have confirmed draw less than 1 watt of standby power (standby.lbl.gov/DATA/1Wproducts.html).

As an energy saving measure, President Bush signed an executive order requiring federal agencies to buy electrical devices with low phantom loads (www.whitehouse.gov/news/releases/2001/07/20010731-10.html). This seems to imply that more extensive federal or laboratory testing of appliances must occur, to provide the information federal agencies will need in order to comply with the executive order. Lasell Horace LasellHJ@navsea.navy.mil

**Think Peace**

Dear Richard, Thank you and your staff for your latest issue of *Home Power*. I am new to the publication and always enjoy reading it when it arrives at our Energy Resource Center. In addition to the great articles, I noticed something special on the spine of the magazine this month, a little gift: "Think Peace!" Thank you for those wonderful words, which seem especially crucial right now. Good wishes to you all for a joyous and peaceful New Year. Thank you, Maggie O'Brien maggieob@hotmail.com

*Hello Maggie, The crew here is dedicated to peace. Some of us are old timers who spent time on the anti-Vietnam picket lines during the sixties. Most of the crew*

*are younger folks and only know about war secondhand. We are all united in not wanting to ever go there again.*

*We consider energy to be an essential element in causing wars, especially those in the Gulf. If we can make energy a gift of nature rather than a commodity to fight over, we'll be much closer to peace. Richard Perez richard.perez@homepower.com*

### **Fishing for a Crimper**

Everyone knows that a good solid crimp is always important in low voltage DC systems. One thing that perplexes me since I never see it mentioned, does any one else use fishing gear? Here in the Marshall Islands, I use a heavy duty, compound-action, Hi-Seas brand crimping tool and what are called mini-double copper sleeves. These are designed to make fishing leader up to and including stuff for catching 1,000 pound plus Marlin. Romex #12 crimped with these sleeves and tool are about as solid a mechanical crimp as you can get. The little black with yellow handle electrical crimper you find in the average store or catalogue just does not compare. Companies like C & H Lures, Mudhole, Melton, and many high quality fishing gear Web sites offer these tools and crimps. The same tool will crimp your regular butt splices, ring connectors, and anything else as well. Sincerely yours, Michael N. Trevor, Majuro, Marshall Islands

*Hello Michael, Great tip! A good crimp is the essential first step in a good, low voltage connection. Without the good crimp, the next step, soldering, is ineffective. Richard Perez • richard.perez@homepower.com*

### **When Not to Use L-16s**

Dear Richard, This is an essay about batteries. Please excuse me if I run on a bit. You and I have both moved up to the industrial grade of batteries with installation of Surrettes. The question I raise here is why it took us, and a lot of the RE community, so long to make this shift. After all, industrial-grade, lead-acid batteries have been around a century or more.

It seems that, for both better and worse, we all fell into the L-16 trap. Now L-16s are fine batteries for many purposes, but they have come to dominate the RE scene in many places where they are not appropriate (a couple of examples below). No doubt *Home Power* magazine has played a role in this. From the earliest days of *HP*, we quite correctly learned that auto batteries were no good for renewable energy systems. Deep-cycle batteries were the way to go and Trojan L-16s just happened to be readily available on the market and were designed for deep-cycle use. So a happy combination of R. Perez and Trojan Batteries led to the

L-16 as more or less the standard for home systems. They are great for small systems, maybe four to eight batteries—good quality at a good price and readily available.

Here in Alaska, the L-16 era was further fostered by Alaska Battery Manufacturers in Fairbanks, who for several years built their own L-16 at an attractive price. If you bought a bunch of them at once, they were available at a good discount. And you could drive your pickup to Fairbanks and avoid the hefty shipping charges from California.

But a lot of battery users leaped onto the L-16 bandwagon when they shouldn't have done so. Here are a couple examples. Several years ago, our local phone company, struggling with the Alaska bush environment, contracted with an electronic engineering firm in Palmer to design and build a remote cell site to be located on a high ridge near McCarthy. Power for the cell site is furnished by a 2.5 KW PV array backed up by a propane-fired Honda generator, all delivered by helicopter. The battery bank, a 24 volt system, consists of 64 L-16s. (Yes, they got a real good price from Alaska Battery.)

I discussed this system with the design engineer at the time they were building it. He said they considered adding Hydro-Caps, but decided against the extra expense. I pointed out that this meant the phone company service technician had to convey by helicopter a 55 gallon drum of distilled water and spend all day unscrewing 192 cell caps in order to routinely water the batteries. He figured that was the phone company's problem. (The phone company got wise real quick and retrofitted the batteries with Hydro-Caps.) If ever a site needed big, industrial batteries, this was it.

This whole business focused my attention when a neighbor near McCarthy scored a very nice system for his large new house (a magnificent log structure). He bought, used, a complete package, including a small building to house it—two stacked SW4024s, an 8 KW diesel generator and (yes, you guessed it) 24 L-16s, these made by Exide. The system had been used for five years by a single previous owner and meticulously maintained. The whole package was professionally designed and built by Remote Power, Inc., an Alaskan outfit that serves bush power needs. It is very well put together with complete monitoring and controls.

Now, instead of running a diesel generator 24 hours a day, he runs his house off the system and only runs the 8 KW generator a few hours a day. He uses about 500 AH each day from the batteries. He plans eventually to add a PV array. He appealed to me for advice when he started running checks on the individual L-16 cells with

a hydrometer and found considerable variation even after some equalizing charges. I checked out the system voltages with my Fluke DMM and found the voltage at each L-16 terminal, with a 45 amp load current running from the whole battery bank, to vary from 5.4 to 6.2 volts. The low voltage units were not the ones with low specific gravity cells.

As a first step to get performance up to speed, I urged him to disconnect and clean every single battery and jumper cable terminal. They look remarkably free of corrosion, but after five years, who knows? I figure that when you try to equalize six parallel strings of four L-16s each, there is no telling how the current is going to be distributed. Again, design ought to call for a single string of twelve, 2 volt, 2,000 AH industrial cells. They will last much longer, and you always know exactly where the current is going, both in and out. We'll do another voltage check after terminal cleaning and equalizing one four-battery string at a time.

Thanks for your patience with this reflection on, you might say, the maturing of the RE industry. And may your PV panels always be bathed in abundant photons.  
Ed LaChapelle, McCarthy, Alaska

*Hi Ed, You are correct regarding the L-16 and its use in large battery banks. We just replaced a three-year-old battery composed of twenty L-16s at Agate Flat. While the pack had received excellent maintenance, it was developing bad cells at an alarming rate. We replaced it with cells that were much larger (and more expensive). We reduced the number of parallel elements in the battery from five strings to two strings.*

*While the L-16 configuration is a good, and inexpensive, beginner's battery for smaller systems, the number of cells required to make a large capacity battery pack is too great. I think that two to three parallel strings are the maximum that should be employed in any battery pack. When the number of parallel elements reaches four and above, it becomes difficult or impossible to keep all the cells equalized.*

*And then there is the matter of maintenance—filling each cell with distilled water and keeping all the terminals clean, tight, and bright. Experience has shown us, and many Home Power readers, that once a battery reaches 1,000 ampere-hours or more, it's time to use the larger, bigger capacity, industrial cells. While initially more expensive, these cells are cost effective based on their longer life and reduced maintenance.*  
Richard Perez • richard.perez@homepower.com

### **Solar Heating Beneath the Trees**

Since reading Ken Olson's excellent series on solar hot water, I've installed two systems at some cabins I own

in northern California. The first cabin uses a standard passive system with a 3 by 8 collector on the roof, a 50 gallon electric water heater as the tank, an El Sol 5 watt solar pump, and a homebrew controller. It works great. The second cabin is hidden in the trees, about 170 feet from the nearest possible collector location. I was concerned that the solar-warmed water would lose its heat in the long pipe run from the panels to the cabin, so I developed a batch-transfer system.

In the sunny area, I mounted two 3 by 8 collectors (obtained used) and two 40 gallon tanks above them so that thermosiphon eliminates the need for a circulation pump. At the cabin, I installed one 40 gallon electric hot water tank. These tanks are connected by insulated and buried 1 inch PVC pipe. At the cabin, there is an electric zone valve that creates a recirculation loop when opened. When more hot water is needed at the cabin, a  $\frac{3}{4}$  hp pump (\$24 from Harbor Freight and Tools) first circulates the cold water in the pipes until hot water appears at the open zone valve. The zone valve then closes and the hot water enters the cabin's tank at the top, pushing the colder water out the bottom and back to the solar tanks. When the cabin tank is full of hot water, the  $\frac{3}{4}$  hp pump stops. The rapid water transfer time minimizes heat loss in the 170 foot pipes.

This process is initiated whenever the cabin requires a new batch of hot water (typically twice a day). I built a simple electrical device to control the process. I'm very happy with the results, although the main drawback is some efficiency loss due to hot and cold water mixing in the tanks during batch transfer.

Having successfully built the system, I began wondering—would a more traditional solar hot water system have worked in this location, considering the 170 foot distance between collectors and the cabin? What would be the maximum practical distance to circulate solar heated water between collector and tank? What technical considerations would be necessary in such extended installations—piping sizes, type of pipe insulation, water circulation speed, revised collector surface area guidelines, etc.? Great magazine, by the way. Chico Woodhill  
chico\_woodhill@hotmail.com

*Chico, I am glad the solar hot water articles have been helpful to you. Stubborn situations such as trees and long distances often challenge our creativity, and it seems you rose to the occasion with plenty of ingenuity. Your solution is unique and it works; that is the bottom line.*

*I think a more conventional approach also would have worked reasonably well with a super-insulated pipe to minimize heat loss. Your expenses for the extra tanks,*



*3/4 hp pump, zone valve, and electricity would have offset some or all of the additional insulation cost. As far as pipe size goes, those two 3 by 8 collectors only require a total flow rate of approximately 3/4 gallon per minute. At that low flow rate, friction loss for a straight pipe run is not enough of a factor to require a pipe as large as you used with the 3/4 hp pump.*

*A closed-cell, elastomeric pipe insulation such as "Rubex" would be appropriate below grade and above the water table. It is rated for temperatures -40 to 200°F (-19 to 93°C). Use the sealant provided by the manufacturer to seal the longitudinal seams and butt joints. You might consider a 3 to 5 inch bed of sand for rocky terrain.*

*It is a costly pipe run no matter how you look at it. Given the unknown and changing variables of temperature, it is hard know with any certainty how much insulation would perform equal to or better than your solution. Unique situations like yours are often best solved, as you have done, by the "empirical" method, which is just a scientific way of saying "just do it" and see how it works. Ken Olson • sol@solenergy.org*

**Factoring in Power Factor**

Dear HP, Several readers sent interesting responses to my guerilla efficiency article (HP92, page 48). The response that rocked my world was from my pal Tim Johnsson, who pointed out that I had neglected to include "power factor" in calculating CO<sub>2</sub> reduction. (For an introduction to power factor, see [www.sylvania.com/forum/pdfs/faq0002-0297.pdf](http://www.sylvania.com/forum/pdfs/faq0002-0297.pdf).)

This was a new one to me. It turns out that powering a 23 watt compact fluorescent requires the utility to generate more than 23 watts! If the bulb has a power factor of 0.5, then the utility has to generate 23 watts ÷ 0.5 = 46 watts.

Strangely, a utility's meter doesn't measure the higher amount, so the utility charges me for only a 23 watt bulb, no matter what the power factor. This means that most consumers have no financial incentive to look for high power factor loads (though off-grid folks with AC wiring certainly do).

Alas, the bulbs we donated to the library are about like the one in the example. I measured one with a Kill-A-Watt meter, which showed that it used 23 watts, but between 42 and 45 volt-amperes, a power factor of between 0.51 and 0.55. TCP does make "high power factor" bulbs, but we didn't know to look for them. And even these bulbs have a power factor of 0.9, so a 23-watt bulb really needs about 25.5 watts from the utility.

In short, while I correctly calculated the money saved by guerrilla efficiency project 0002, my numbers for the reduction in environmental impact were high by about 20 percent. (The folks who pioneered guerrilla efficiency project 0001 don't mention power factor in their calculation, either. I hope future guerillas will factor it in.)

Here is a revised calculation of dollars and CO<sub>2</sub> saved, assuming the bulbs have a PF of 0.5 and the air conditioning a PF of 0.7 (an estimate from a friend in the energy business). I also used a more accurate value of CO<sub>2</sub> produced per KWH at [www.eia.doe.gov/oiaf/1605/e-factor.html](http://www.eia.doe.gov/oiaf/1605/e-factor.html).

All this brings up a slew of questions:

- How easy is it to get high power factor bulbs? Do they cost more than bulbs with poor power factor?
- If I have a grid-tied PV system, do high-PF appliances save me money when the panels are generating electricity? Or only when the system spins the utility meter backwards?
- To calculate CO<sub>2</sub> abatement, is it correct to use KVA generated instead of KWH consumed? Since the

**Public Library Lighting Retrofit Savings (Revised from HP92 Page 50)**

Item	Without Power Factor Computed					With Power Factor Computed				
	Savings (Watts)	Savings per Wk. (KWH)	Savings per Yr. (KWH)	Savings per Yr. (US\$)	Abated CO <sub>2</sub> per Yr. (lbs.)	Savings (V-A)	Savings per Wk. (KVAh)	Savings per Yr. (KVAh)	Savings per Yr. (US\$)	Abated CO <sub>2</sub> per Yr. (lbs.)
Lighting load reduction from 75 W to 23 W for 24 CF bulbs replaced	1,248	50	2,596	\$337	4,309	696	28	1,448	\$337	2,403
Air conditioning load reduction for 24 CFs replaced, estimated	374	15	778	101	1,291	535	21	1,113	101	1,847
<b>Totals</b>	<b>1,622</b>	<b>65</b>	<b>3,374</b>	<b>\$438</b>	<b>5,600</b>	<b>1,231</b>	<b>49</b>	<b>2,561</b>	<b>\$438</b>	<b>4,250</b>

Assumptions:

- 40 hours per week average light usage
- 1.66 lbs. CO<sub>2</sub> per KWH electricity
- US\$0.13 per KWH electricity cost
- Power factors: CF = 0.5; A/C = 0.7

DOE's numbers refer to energy generated, I suspect so, but would like someone to confirm this.

- As consumers switch from incandescent to fluorescent bulbs, aren't utilities getting squeezed, sometimes having to produce half the juice for one quarter the pay?
- If my \$35 watt-meter can measure the utility's load in kilovolt-amperes (KVA), why don't utilities get modern meters, which charge for the power they actually have to generate?

I hope you and your readers have some insights into these questions. Carol Montheim  
carolmontheim@earthlink.net

*Hey Carol, Great point about the effect power factor has on CO<sub>2</sub> reduction calculations. Several CF manufacturers make high power factor bulbs. These bulbs are typically labeled HPF (high power factor), and have a power factor greater than 0.90. A Web search using the key words "high power factor compact fluorescent" turns up several retailers of HPF bulbs. Also, try searching the Web sites of bulb manufacturers for model numbers of HPF bulbs. The cost of HPF bulbs is typically higher than bulbs with poor power factor.*

*High power factor appliances use energy more efficiently than low power factor appliances whether the electricity is being generated by the grid or by an inverter. In a grid-tied PV system, the inverter is in phase with the grid. Reactive loads like compact fluorescent bulbs are out of phase with both the inverter and the grid, and not using all the power being delivered to them. If you're using PV and an inverter to make electricity, low power factor appliances matter, off-grid or on.*

*These days, the majority of appliances in a given home or business are reactive and power factor comes into play. The only appliance at my place that isn't reactive is the toaster! The utilities are definitely getting squeezed as a result. A utility engineer once told me that power factor is like the head on a beer. You make it, but you don't always use it. In industrial applications, utilities often require large manufacturers to install capacitor banks or other methods of power factor correction to minimize power factor losses.*

*Chances are that the utilities will eventually begin using KWH meters capable of measuring the reactive component of customers' loads. Even though it will cost people more, it will be better for everyone in the long run. High electric rates encourage conservation and sensible energy use. Eventually, it's going to be less expensive to make the stuff yourself if you're on grid. Bring it on! Thanks for all the thought provoking*

*questions. Joe Schwartz  
joe.schwartz@homepower.com*

### **Evergreen Cost**

We were intrigued by the Evergreen Solar article in *HP93* (both from a user point of view as well as being potential investors), but noted that you said nothing about whether they intend to cut prices to reflect their raw material costs. Their Web site demands that we give all kinds of personal access info in order to further pursue dealers of their panels, and we refrained to avoid being on mailing lists (since they didn't offer such an option when requesting our personal info). It would have been neat to hear something about their market strategy as to pricing. If they're saving so much, are they anxious to pass on those savings to the consumer? Thanks, David & Vickie  
d-v-bearman@cybrquest.com

*Hello David and Vickie, I suspect that Evergreen PV modules will be substantially less expensive in the future. Right now, as a new start-up company in an incredibly capital-intensive field, they are working hard to pay off their large debt for manufacturing equipment. Once this is done, I expect their prices will decrease.  
Richard Perez • richard.perez@homepower.com*

### **EV Plans**

Dear *Home Power*, First allow me to say I enjoy reading *HP*—I'm just beginning my second year. I'm sitting here in prison educating myself in math, attempting to learn algebra and electronics. I have ideas of building an electric vehicle, except I want to combine solar power with the batteries for charging full-time during the day. I've read articles on converting a vehicle and then plugging it into an outlet, usually a nuclear or fossil fuel generated source. I have read of a company using solar power to charge the auxiliary battery of an EV, but that's where they stopped with the solar power.

I believe it can be done. I want to use a full-size van and cover the roof with solar panels to charge the entire battery bank. Being in prison makes it difficult to access detailed information of a technical nature. It took over three months to obtain the dimensions of the roof of a full-size van. Now I'm trying to find the dimensions of the components such as frame rails underneath a full-size van to determine placement of battery racks beneath the body of the van. I'm looking for range and some versatility of it as a runabout vehicle, not for long distances or for hauling cargo, beyond the occasional sheet of plywood or whatever from the lumberyard.

I don't claim to know or understand a lot about solar power, but I believe that the array could charge sunrise to sunset, and while the vehicle sits during the workday. I could use all the technical help I can get in the design

stage. The only access to information I have is through the mail, and funds are limited. Also I think when a company or publisher sees my prison address, they just toss out my request. Respectfully, Thomas Scott, #208903, Pine River Correctional Facility, 3320 N. Hubbard St., St. Louis, MI 48880

*Hello Thomas, I wish I could be more encouraging, but the numbers just aren't there. There are two problems with this plan. First, a full-size van is too heavy to make a good conversion. Second, even a van doesn't have enough roof for enough panels to give more than a fraction of the needed charge. If you take a look at solar transcontinental racecars, you will see that they use very large arrays of often satellite grade solar panels to move a vehicle that weighs only a few hundred pounds.*

*On the bright side, there is no reason that an EV has to be charged from the grid. With a properly set-up RE system of sufficient capacity, an EV can be charged from clean sources at home. See Will Beckett's article on charging his EV in HP78. Mike Brown & Shari Prange, Electro Automotive*

#### **NABCEP Raises Bad Memories**

I would like to comment on the NABCEP proposal as addressed by Mr. Marken in *HP92*. I propose that NABCEP abandon certification as such and substitute accessible (to anyone) education as the first goal, with certification of completion as the goal. I suggest this due to my experiences in previous businesses. My steel fabrication and manufacturing company employing 120 people received certification for any application I submitted. I owned the company, was self taught, and could do every job including building structural steel for buildings to 23 stories, pressure vessels to 10,000 PSI pressures (API & ASME), and heavy transportation equipment.

After retirement, I went into the RV business as a repair shop, capable of repairing all parts except power train (don't like grease) on all existing travel trailers, motor homes, and boat living quarters. I employed several technicians on a seasonal basis. When certification came into being through RVIA, I applied for testing for certification based on my ten years of hands-on experience in the business. RVIA made no provisions for me to gain certification and adamantly stated that my supervisor for the last ten years must request that I be tested and certified. Nothing would move the RVIA from that stand and I finally blew them off, since I had been successful for ten years without them. For that reason alone, I am not a supporter of any national certification scheme. I would support certification at the state organization level only if provisions are made to base said certification on knowledge and not on previous employment.

Any certification based on previous employment in an industry is without question an attempt by those already employed in the industry to keep others out by legislation or regulation. Requiring them to work cheaply for someone else for an extended period of time before being considered ready for certification is a sham.

When I left the U.S. Army during Vietnam, I went to work for an electrical contractor as an apprentice. Within 12 months, I was wiring new houses and doing repair calls without a master electrician present. Within 14 months, I headed a crew wiring apartment complexes in Arlington, Texas and Stillwater, Oklahoma. When I asked to be paid for my work as a supervisor, I was told that I had to complete a 2 year apprenticeship. Whether I could do the work and pass the test for master was not in question! A master electrician is required on these jobs, but was only present on Monday morning when the city inspector came by.

I quit that day, determined to never work for anyone requiring me to put in my time according to some arcane rule intended to make me work for low wages for an arbitrary period of time despite my doing master of the trade work. I believe this is only a way to limit the number of supposedly qualified workers in order to maintain union wages and jobs through scarcity of labor and to control entry into the workforce in question.

I have lost track of how many systems I've installed and wonder just who would certify me (since I work alone much of the time & cannot certify myself) and other small business people under the onerous rules written by this organization. I think it's a power grab.

If I wanted to spend all that time to achieve certification, I could simply go for an engineering degree and would not need certification by such an organization anyway. There are high quality college courses leading to 2 year and 4 year degrees in renewable energy for technicians and engineers. San Juan College in Farmington, New Mexico offers a great course.

This is quite simply an attempt by the IBEW and others to pre-empt the many who have worked to build this industry with some regulation to place the NABCEP people and the IBEW in charge to the detriment of small business and the consumer. Everyone wonders why we have a shortage of skilled labor in the U.S. This kind of thing causes bright young people to seek other ways to make a living. This is why I do not support such schemes to hold the best and brightest to the same level as the lowest and slowest. Thank you. Ed Hudgins



# Ozonal Notes

## Solar Energy at the White House?

Richard Perez

©2003 Richard Perez

**W**hen I first saw the press releases stating that a PV system had been installed at 1600 Pennsylvania Avenue, I couldn't believe it. The Bush White House going solar? Incredible!

Nevertheless, in fact, it's true. In August 2002, solar-electric *and* solar hot water systems were installed on the White House grounds. When I read about it, you could have knocked me down with a feather!

### PV System

The solar-electric system consists of 167 Evergreen Solar, 51 watt, photovoltaic (PV) modules. For an article about Evergreen Solar and their modules, see *HP93*, page 72. This 8.5 KW PV array feeds three SMA 2.5 KW Sunny Boy utility-intertie inverters.

The energy produced by this array enters the local utility grid on the White House grounds, where it is net metered at about US\$0.07 per KWH by Potomac Electric Power, the local utility. The installation features an extensive data acquisition system that monitors the performance of both the PVs and the inverters. During the first four months of operation, this system produced an average of 26.25 KWH per day.

Steven Strong of Solar Designs Associates in Harvard, Massachusetts designed the system. One of the reasons that Steven selected Evergreen Solar's PV modules was that they are American made. Steven said, "Evergreen Solar is the classic, home-grown success story, where a small group of dedicated individuals, starting from modest beginnings in a 'garage,' proved the commercial viability of their technology, and subsequently have become a significant player in the global solar market."

The system was installed in three days by Aurora Energy of Annapolis, Maryland, and is located on a maintenance building's roof in the southwest corner of

the White House grounds, not on the actual White House itself. The project was funded by the National Park Service.

James Doherty of the National Park Service said, "We don't view this as an experiment. We believe in these technologies, and they've been working for us very successfully. The National Park Service as a whole has long been interested in both sustainable design and renewable energy sources. We also have a mission to lower our energy consumption at all our sites, and we saw an opportunity to do both on the White House grounds."

### Solar Hot Water System

In addition to the PV system on the grounds, the White House got solar-heated water. Two solar thermal systems provide hot water, one to heat the presidential pool and spa, and another for domestic hot water needs. Day Star Energy Services of Silver Spring, Maryland installed these solar thermal systems. The domestic hot water (DHW) system is mounted on the same roof as the PVs. The spa system is located on the cabana roof by the pool.

Both solar hot water systems are of the drainback type. The pool heating system uses building-integrated SunEarth panels. The DHW system uses a more conventional approach—two SunEarth flat panel collectors feeding a storage tank with an internal heat exchanger. The DHW system provides hot water for the cabana and not the main White House building.

### The Details & the Devil Therein...

Once I heard about the PV system on the White House grounds, I immediately began to wonder what it really meant. How much of the buildings' load was being powered by solar energy? After exhaustive research, I was unable to get any information about how much electricity the White House uses. Perhaps this information is classified for national security reasons.

If the White House is similar to other government mansions (Dick Cheney's, for example, consumes 2.6 MWH annually at a cost of US\$186,000 to the taxpayers), then the amount of its energy that comes from the PV array is a miniscule fraction of 1 percent. While I found this conclusion disappointing in light of the thousands of completely solar powered homes owned by *Home Power* readers, I took heart—at least the White House was taking a step in the right direction.

When I tried to find out the cost of the White House's solar energy systems, I found that this information was also unavailable. What I did discover is that these systems were actually initiated by the Clinton administration, and it took all this time for them to work

their way through the morass of federal bureaucracy and to finally be installed.

### The Future Is in Your Hands

It has been said that the truth suffers from too much analysis. In the case of the White House's solar energy systems, this is most certainly true. The closer I looked, the less excited I became. When I dug deeper into the public archives, I found nothing from President Bush that even acknowledged that these systems exist. No ribbon cutting ceremony, no photo op, no public statement, nada.

What the White House solar energy systems have done is reinforce my belief that the future of solar energy lies with the people, not with governments and the big businesses that control governments. Solar energy is nature's freely offered gift to everyone. The powers that be consider energy to be a commodity to sell, to manipulate, and to go to war over. To ask them to foster solar energy is unrealistic. We, the people, must do this job for ourselves.

### Access

Richard Perez, *Home Power*, PO Box 520, Ashland, OR 97520 • 541-941-9716 • Fax: 541-512-0340  
richard.perez@homepower.com  
www.homepower.com



If you're not reading  
**Home Power** magazine...  
you're still in the dark.

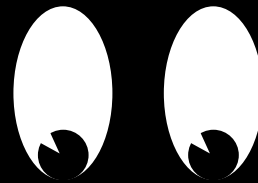

**HOME POWER**  
THE HANDS-ON JOURNAL OF HOME-MADE POWER

800-707-6585  
www.homepower.com

Clean Air.  
Clean Water.  
Clear Conscience.

*Be part of the solution.*  
Go

**SOLAR TODAY**

a publication of the American Solar Energy Society (ASES)  
www.solartoday.org • (303) 443-3130 ext. 2

**Join ASES Today.**

For only \$70 per year, you can support the American Solar Energy Society (ASES), the oldest and largest national organization dedicated to advancing the use of solar energy for the benefit of U.S. citizens and the global environment. Your membership includes a subscription to SOLAR TODAY magazine.

For more information, contact ASES, 2400 Central Avenue, Suite G-1, Boulder, Colorado 80301, (303) 443-3130, ext. 2, FAX (303) 443-3212  
e-mail: ases@ases.org, web site: www.ases.org.

# Q&A

## Stove Igniter Problems

Hello *HP* crew, I have a question about gas ranges with electric igniters on the oven. My Trace DR2424 inverter seems to run the oven fine for a while. Then when the batteries are at about 75 percent, it will only give the igniter 80 percent of rated amps, which will not let it set off the safety valve unless I manually hit it with a sharp blow. I presumed the inverter would deliver rated power all the time, or shut down when the batteries are too low. Also, now I believe the transformer in the oven has been damaged enough that whatever the battery charge is, it will not run. So is this a common problem for anyone else with modified square wave inverters? Sincerely, Steve Smith

*Hello Steve, This is a common mod-square problem. Many electronic circuits and transformers find the waveform barely digestible. The peak voltage of the modified square wave depends on battery voltage. Low peak voltage can cause many problems in transformers, and in power control circuits employing thyristors. The fix is to go sine wave. Modern sine wave inverters are not very much more expensive than their modified square wave counterparts. Richard Perez richard.perez@homepower.com*

## Modular RE

I have been reading a lot about solar electricity and net metering with a small system. My question is, can you have a larger inverter than you need for say one or two solar-electric modules, with the plan of increasing your array size later without having to get another inverter? I live in Missouri, one of those backwards states that do not have net metering. Thanks, Charlie Ware

*Hello Charlie, One of the great things about solar electricity is that it's a modular energy source—your system can easily grow as your energy needs do, or when money's available.*

*You're right on track regarding inverter sizing. If you plan to increase the number of solar-electric modules as time goes on, it's a good idea to get an inverter that has the capacity to handle future growth. I suggest that you talk with an RE dealer in your area. Go to our Web site, and under the community link, go to RE Directory. From there you can search for RE companies close to you in Missouri and get help with system design and installation. Best of luck with your project. Joe Schwartz joe.schwartz@homepower.com*

## Focusing Wind

I have been an avid reader of *HP* for more than a year now and can't wait to read the next issue as soon as I power through the current one. Excellent magazine.

My question: At what point does a diffuser assisted wind turbine (DAWT) become too much hassle? The idea of using the diffuser is great, but it doesn't work on large-scale machines. Everything just gets way too big and heavy. That company down in New Zealand or Australia went bankrupt trying to make a viable product. I just read about a German company, Enflo Systems, that provides 0.5 to 400 KW DAWTs. Do the problems associated with the diffuser outweigh the benefits of the increased airflow? Would it work effectively on small-scale wind turbines, say 1 or 2 KW? Your thoughts and insights are appreciated. Regards, Stephan Storms

*Hi Stephan. A diffuser is like a big funnel that forces (or sucks) the wind through a hole that is smaller than it would normally flow through. This is attractive because it should provide higher wind speeds, which can be captured by a smaller diameter wind turbine. Another apparent bonus is that the smaller turbine will run at higher rpm than the corresponding larger rotor would. The downside is that you need to support an ugly great lump of stuff around the turbine, and this structure also needs to be rotated to face the wind.*

*In practice, the performance benefits have been disappointing. They have not proven to compensate for the problems of this clumsy structure. I am not aware that the advantages are any greater for small machines than they are for large ones. People will continue to experiment with this idea, just as some others will experiment with vertical axis wind turbines, in the hopes of a breakthrough. But as yet, neither idea has translated into a useful product for widespread use. Where a natural or an architectural funnel already exists, benefits can be available in some wind directions, but building a diffuser has not proven to be a good idea. Hugh Piggott • hugh@scoraigwind.co.uk www.scoraigwind.co.uk*

## Glycerin Surplus

Dear *Home Power*, I've been wondering how people use all the glycerin from a serious biodiesel distiller. My wife makes soap that could use some glycerin, but we have the potential to use a lot more fuel than soap. What happens to the glycerin when you dump it on the compost pile? Is all the residual methanol locked up in the biodiesel? How about disposing of the dregs? Are there markets for small batches of glycerin? Where does the cosmetic industry get its glycerin? Thanks, Cliff Millsapps

*Hello Cliff, Glycerin is a significant factor with any biodiesel production plan—it represents around 20 percent of the total stream flow. It's a water-based compound that solidifies at up to 65°F, and can be a handling problem. Glycerin also has most of the French fry bits, and the majority of the excess methanol. I've dealt with this for years, trying many systems unsuccessfully, but that's the way you learn!*

*Here's what I do now: glycerin is high in carbon, low in nitrogen, and alkaline, so it works well with nitrogen rich and acidic manure piles. A large manure pile will melt the glycerin and speed its decomposition, and the methanol will also be absorbed and degraded. Second, glycerin will burn very cleanly if it is in a really hot burner, approximately 1,000°F. That happens in a hot wood fire or in a cleverly constructed crucible furnace. Give it lots of air so potential toxic byproducts are not produced. Finally, commercial glycerin is so cheap that it's hard to refine the byproduct to be competitive. Try to develop a market for French-fry flavored soap. Tom Leue • tilapia@aol.com*

*Cliff, After doing some research, I found that I can sell glycerin to chemical plants that will process it, but I need a truckload at a time (roughly 5,000 gallons). For smaller batches, the methanol can be recovered from the glycerin by first placing the glycerin in a heated container under vacuum. The methanol will condense in a separate container (a condenser). From there, you can test the pH of your glycerin, and as long as it's close to 7, you are free to compost it. Please keep in touch and I'll be happy to forward more information as it becomes available. Best, Joshua Tickell  
Tickell@VeggieVan.org*

**How Much Is a Ton of CO<sub>2</sub>?**

Lots of folks speak about tons of CO<sub>2</sub> mitigated by changing to CFLs, or installing wind generators or PVs. I'm trained in the sciences, and yet I have no idea what a ton of CO<sub>2</sub> looks like, or what size it is. I know, I know—it's the same as a ton of rocks or feathers.

But if with a lot of science education, I can't quite grasp what this quantity is or represents, how is the average human on earth supposed to grasp the concept? Any help from HP on how to grok (that is, get my head around) a ton of CO<sub>2</sub>? Mick Sagrillo

*Mick, You're right. It is hard to get an idea of what a ton of CO<sub>2</sub> looks like—it is a colorless (and odorless) gas. I think it makes much better sense to talk about the carbon that goes into making the carbon dioxide. A gallon of gasoline contains approximately 5 pounds of carbon (gasoline weighs about 6 pounds and most of this is carbon). So when you burn 120 gallons of gasoline, you add about 600 pounds of carbon to the atmosphere, which is about 2,200 pounds, or a metric ton of carbon dioxide.*

*If you have to think in terms of the weight of carbon dioxide, you could think of dry ice—frozen carbon dioxide. Imagine a ton of dry ice sitting on a scale. As it goes into the atmosphere, the scale shows less and less weight, going to zero when the dry ice is all gone. But the CO<sub>2</sub> in the dry ice still exists. It's just not weighable as it floats in the atmosphere. A ton of water still exists even after it has evaporated. It's just not easily weighable when it is in the atmosphere. Dan Ihara, Executive Director, Center for Environmental Economic Development (CEED)  
ceed@humboldt1.com*

**NiCd & NiMH**

Dear Richard, I have a question that as a fellow ham radio buff, I am

almost shy to ask. What is the difference in the way that a NiCd and a NiMH battery are charged? Can you charge both in a standard battery charger that is rated for NiCd batts? Thanks, Norman

*Hello Norman, There is no difference in the way these two batteries should be charged. Both NiCd and NiMH use the same anode material (nickel) and the same electrolyte (a paste of potassium hydroxide [KOH] in water). Only the cathode material is different—cadmium in NiCds and a mixture of metals (mostly titanium hydride) in NiMH batteries. The charge regime and charge profile are identical, and both can be charged in a standard NiCd charger.*

*We have switched from NiCd to NiMH for all our portable stuff—handheld 2-meter radios, flashlights, portable audio gear, and camcorders. We've been using chargers that, while they don't say so, will do both NiCd and NiMH. Richard Perez  
richard.perez@homepower.com*



**Daystar's  
Solar Meter**

The easiest way to  
obtain accurate  
irradiance  
readings

\$134.50+  
S&H

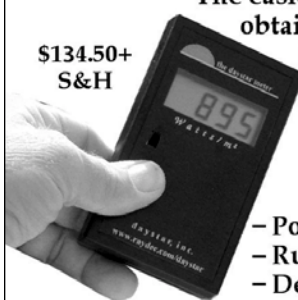

— Pocket-sized  
— Rugged  
— Dependable  
— Consistent

2.6" x 4.5" x 0.9"

**Calibrated in Watts/m<sup>2</sup>, these meters provide accuracy better than ±3% at 1000 Watts/m<sup>2</sup> and air mass 1.5. Resolution is 1 Watt/m<sup>2</sup>.**

3240 Majestic Ridge  
Las Cruces, New Mexico 88011  
505-522-4943  
pvvern@zianet.com  
www.raydec.com/daystar



## Home Power MicroAds



Rates: 25¢ per CHARACTER, include spaces & punctuation. \$20.00 minimum per insertion. All MicroAds are published in both the print and web versions. Please send a check or Visa, Mastercard, American Express, or Discover card data with ad. Please, no money orders. We do not bill MicroAds, they must be paid for in advance of publication. Your cancelled check or credit card bill is your receipt.

Help us prevent fraud! Home Power MicroAds from individuals must supply serial number(s) for equipment being sold. Businesses must supply published phone number(s) and physical address. While Home Power is doing everything we can to prevent fraud, we can assume no responsibility for items being sold.

PHOTOWATT DROPSHIPED FROM FACTORY DIRECT TO YOU, \$3.30 PER WATT, 25 yr warranty. Minimum order 10 modules. Contact Sun @ 305-381-6166. •HP9431

WIND TURBINES! Best prices nationwide. Bergy - AWP3.6 - Turbex. www.pineridgeproducts.com 406-738-4284 •HP9402

HYDROELECTRIC SYSTEMS: Pelton and Crossflow designs, either complete turbines or complete systems. Assistance in site evaluation and equipment selection. Sizes from 100 watts to 5 megawatts. Manufacturing home and commercial size turbines since 1976. Send for a free brochure. Canyon Industries Inc., P.O. Box 36 HP, Deming, WA 98244, 360-592-5552. e-mail: citurbine@aol.com web page: canyonindustriesinc.com •HP9403

FOR SALE - XANTREX STOCK Former employees wish to sell stock to qualified investor. Several million shares available. \$0.75/share OBO.360-435-6030 •HP9404

EARTH SHELTERED HOMES This definitive manual by noted authority Loren Impson features detailed building instructions for amazingly affordable and practical Ferro Cement Domes. Only \$15 from Loren, 71 Holistic, Mt. Ida AR 71957 www.2BbyD.com •HP9405

COSOLAR.COM discount division of Colorado Solar Electric. SunWize single-crystal panels \$4 per Watt. Siemens SP75 \$339. OutBack Products in stock 1-800-766-7644 •HP9406

SINGLE AND DUAL AXIS SOLAR TRACKER CONTROLS up to 48V and 5A output. www.theanalogguy.com •HP9407

ALMOST FREE SOLAR POWER! Unbelievably cheap (under \$500) DIY systems for home, cabin, rv, boat. PowerFromSun.com. •HP9408

RADIO/TELEPHONES Voice-Fax-Web 1-8 lines 20mi. CELLULAR Antenna pkg improves access 208-263-9755 PDT •HP9409

DANBY PROPANE 8 cu. ft. refig. freezer \$800 shipped direct from factory. Call Sun 305-381-6166 •HP9431

POWERPULSE® SULFATION BUSTERS endorsed by R. Perez! 12V \$69.95 free UPS. 800-222-7242 for other models/wholesale prices. email: abrahamsolar@hotmail.com Siemens 40 watt: \$170! Ask about other surplus modules or any energy gear. Veteran Colorado equipment broker; happy clients since 1984. •HP9411

VIDEOS AVAILABLE: "Introduction to Solar Electricity", "Introduction to Solar Pool Pumps", "How To Solar Installation Video" VHS and DVD www.igotsolar.com •HP9412

ECOMALL: The largest environmental portal of earth-friendly companies and resources. Renewable energy companies, news and information. www.ecomall.com To advertise, call 845-679-2490. •HP9413

KUBOTA DIESEL GENERATOR Low Boy 6.5 KW, super quiet, only 64 DCB. Only \$3,550. Call Sun 305-381-6166 •HP9431

SOLAR FRESH AIR HEATER-It's been proven by the Department of Energy that 30 degree air can be raised to 80 degrees with Solarwall. No maintenance and low power draw. Solar Unlimited, Inc. (435) 867-9876 www.solarunlimited.net •HP9414

SURPLUS INDUSTRIAL BATTERIES MADE IN N. AMERICA. Save up to 70%. Unused, factory crated, sealed no maintenance, xtra h.d. steel cases, removable cells. 600 to 2800 AH, 12-24-48V. Call for info. D.P.S.D. Inc. 3807 W. Sierra Hwy. #6, Acton CA 93510. 661-269-5410, amwind@earthlink.net •HP9415

Run your portable gasoline generator on propane or natural gas. Easy, low cost, do-it-yourself change over kits. www.propane-generators.com or 800-553-5608 for free brochure. •HP9416

LARGE PROPANE REFRIGERATORS 10, 15 & 18 cubic foot propane refrigerators. 15 cubic foot freezers 800-898-0552 Ervin's Cabinet Shop, 220 N County Rd. 425E., Arcola, IL 61910 •HP9417

XXXXXXXXXX USED SOLAR MODULES XXXXXXXXXXXXX XXXXXXXXXXXXX 64 Watts \$319 XXXXXXXXXXXXX New recondition Trace SW5548 (GTI unit) 1 year warranty \$2950. Used MSX80s \$295, BZ 16 amp PWM digital controller \$84, Ex 2KW inverter SB, 110 amp charger New \$850, new 165 Watt modules \$742(min 2). Buy, sell New/Used, Trace, NiCds. refrigerator. Try to match anyone's prices. Call or send S.A.S.E. to Craig Eversole, 10192 Choiceana, Hesperia CA 92345 for free flyer. M/C VISA Discover 760-949-0505 •HP9418

Honda Generators - 1000 to 10,500 watts. Fast shipping and great prices! www.hayesequipment.com 1-800-375-7767 •HP9419

AIR LAND 403 \$349 305-539-0403 •HP9431

VERMONT PV DEALER. David Palumbo/Independent Power & Light has been designing and installing PV systems for more than 12 years. Trace and Exceltech inverters. Siemens, BP, Kyocera and Solarex PV's. Harris Hydro. Surrette, Rolls, and Dyno batteries. Honest dealer who offers personal support and service. "David is one of the original RE pioneers... he knows how to really squeeze all the energy out of a KWH!" Richard Perez (HP60). I P & L, 462 Solar Way Drive, Hyde Park, VT 05655. Phone 802-888-7194. Email: ipl@sover.net. Web site: www.independent-power.com. No catalog requests please. Please call for appointment before visiting. •HP9420

Rent my mailing list of 9000 US residents who have spent money on renewables. Contact carguy2101@aol.com or 631-831-8436 •HP9421

DC SUBMERSIBLE WELL PUMPS. Complete, ready to install. \$180 includes IMMEDIATE FREE SHIPPING. Visit www.nemopumps.com or call 1-877-684-7979 •HP9422

I AM A SOLAR WHOLESALER looking for retailers to carry my solar electronic and hobby goods. Phone # (916) 486-4373. Please leave message. •HP9423



WANTED: SOLEC SQ-80 solar module. E-mail wstef@yahoo.com or call 650 740 3337 •HP9424

TELLURIDE COLORADO: Off the Grid Properties! Hot Springs, Riverside, solar powered homes, large and small ranches. Find your own place in the sun with the only solar powered real estate office in Colorado. T.R.I. (970) 728-3205 1-800-571-6518 •HP9425

LIKE NEW! Still in factory box: Solarjack 4gpm 1/2 hp 45V well pump \$300., also for sale Dankoff Flowlight Booster pump 4.1-4.5gpm 12V \$200. Serious buyers only. AZ Call 928-339-4623. •HP9426

EDTA RESTORES SULFATED BATTERIES. EDTA tetra sodium salt, \$12/lb. plus \$5 S&H for 1st lb. plus \$1 S&H for each additional lb. Trailhead Supply, 325 E. 1165 N., Orem, UT 84057, (801) 225 3931, email: trailheadsupply@webtv.net, info. at: www.webspawner.com/users/edta. •HP9427

W.R.S Solar-Air-Refrigeration AC DC Elec. energy efficient POB 103 Portage OH 43451 PH 419.686.7095 Seminars being formed to build your own •HP9428

POND AERATION WINDMILL: Koenders 12 ft. Tower, Galvanized Steel, 100 ft. Air Line, Air Diffuser: \$650. Electric Aerator System: \$495 Ask for Free Brochure. WaterQualityUSA.com — Tel: 800-470-4602 — www.PondWindmills.com •HP9429

RADIO/TELEPHONES Voice-Fax-Web 1-8 lines 20mi. CELLULAR Antenna pkg improves access 208-263-9755 PDT •HP9409

WWW.PICOTURBINE.COM is your renewable energy superstore! Free plans, discount books, inexpensive kits for students and adults. Build your own windmill, solar cell, more! •HP9430

EDUCATIONAL WINDMILL KIT Really produces electricity! Perfect for science fairs, experimenters, homeschools, hobbyists. For ages 10 to adult. Thousands sold. Design first appeared in HomePower Magazine! WWW.PICOTURBINE.COM •HP9430

BRAKEDRUM WINDMILL PLANS Build a Hugh Piggott's wind turbine design from scrap parts. Produces 300 to 400 watts. Tested design built all over the world. Available in the USA only from WWW.PICOTURBINE.COM •HP9430

EBOOKS ARE GREEN! WWW.FICTIONWISE.COM has over 2,000 electronic books available for immediate download in all subject areas. Award winning authors, all PDA and Computer formats supported Read ebooks to save trees! •HP9430

REMANUFACTURED INVERTERS, LARGE INVENTORY, UP TO 55% OF LIST,with factory warranties, all brands, all sizes. Call Sun at 305-536-9917 can be drop shipped from factory. •HP9431

NEW MEXICO LAND OF SUNSHINE! Many solar properties. Land and Homes. www.swnmrealestate.com Call Billy Donnel at Re/Max Silver Advantage 505-538-3847 Cell 505-574-2603 •HP9432

HIGH IN SE ARIZONA: solar powered rammed earth home 1326 sq ft on 44 acres 5000' in mts. Very secluded, oak trees, beautiful views. Historic homestead w/ shop & guest house. Good well w/ windmill. (520)642-3229 or conaway@c2i2.com •HP9433

SAN DIEGO CALIF SOLAR SHOWROOM AND RETAIL MAIL ORDER CATALOG: Horizon Industries has been servicing, designing and installing solar hot water, solar pool heating, and solar electric systems since 1984. We invite you to see the best solar equipment in our showroom at 120 N. Pacific #G7, San Marcos or request a mail order solar catalog at (760) 744-1001 if you live outside San Diego County. Information available for the grid connected PV net metering rebate up to 45% from the State of Calif. •HP9434

AMSOIL Synthetic Lubricants \* Use Less Oil, Save Fuel, Extend the Life of Your Equipment \* Save the environment while saving money \* Independent Dealer www.zamslube.com 210 392-3631 FAX 210 521-7635 •HP9435

SUNNY BOY 2500 INVERTER with DISPLAY: \$1700 + shipping from CA. New, in box, never used; factory warranty. godz13@attbi.com; 310 / 649-1754. •HP9436

12 USED C&D TECH BATTERIES One cell (2VDC), 1176AH w/bus bars to connect for 24VDC, rack, 188lbs. ea. Buyer to pick-up or pay shipping from central PA \$2400.00 OBO (717)258-3206 •HP9437

NE AZ 40 acres/cabin/96 mobile/solar/well/more!\$90K (602)809-8708 PhxRealtor@AOL.com(photos) •HP9438

FOR SALE - 99' Wht Sunfrost RF16 Refrig., Unit # 5745. \$750 obo. 909/719-3115 in SoCal. •HP9439

DIESEL CAR. 1999 VW TDI JETTA. 50 MPG will deliver. \$9500. Jim, 989-872-3424 or 989-757-6109 •HP9440

TRACE ST-1000 INTERTIE INVERTER. New in box. \$995. MC/Visa accepted Jim, 989-872-3424 or 989-757-6109 •HP9440

USED MIDWAY MLB 3416-115 Solar Modules; some functional, some less so. Free for pickup. Allyn or Mary, 909-698-8072, Murrieta, CA. HP9441

17.5 KWH JACOBS WIND TURBINE on 120 ft self standing tower with Mastermind grid intertie inverter. \$12,000.00 Call 715-682-9240 •HP9442

VARI-CYCLONE: DC powered ceiling fan, 40% more airflow with no increase in power consumption. For more info contact RCH Fanworks, the #1 manufacturer of DC powered ceiling fans, 2173 Rocky Crk. Rd. Colville, WA 99114 PH: 509-685-0535, email: info@fanworks.com, Web: www.fanworks.com, Dealer inquiries welcome. •HP9443

WINCHARGER PARTS. New and used. (716) 358-2534 New York. (406) 547-2266 Montana •HP9444

Att. GUERRILLAS the 100 watt OK4U (AKA TRACE micro sine) is on sale now for \$249.00 at, http://gridtieinverters.homestead.com/frontpage.html or call SUNPOWER at 310 383-6698 HP9445



## Index to Advertisers

- AAA Solar Supply — 103  
ABS Alaskan — 85  
Abundant Renewable Energy — 33  
Adopt a Library — 130  
Advanced Communication Solutions — 77  
Advanced Composting Systems — 115  
Alternative Energy Engineering — 29  
Alternative Energy Solutions — 115  
Alternative Energy Store — 33, 90  
Alternative Power & Machine — 17  
Alternative Technology Association — 131  
Amazon Power Company — 131  
American Solar Energy Society — 139  
Aquatherm Industries — 91  
B.Z. Products — 103  
BackHome — 84  
Backwoods Solar Electric Systems — 69  
Bailey's Inc — 115  
Bergey Windpower — 28  
Bogart Engineering — 85  
BP Solar — 2  
Brand Electronics — 105  
C. Crane Company — 125  
CheapestSolar.com — 99, 114, 128  
Communities magazine — 124  
Dankoff Solar Products — 17, 58  
Daystar — 141  
Direct Power and Water Corp — 68  
Earth Solar — 98  
EcoLogics — 125  
Electro Automotive — 90, 124  
Electron Connection — 35  
Energy Designs — 119  
Energy Conservation Services — 67  
Energy Outfitters — 9, 46  
Energy Systems & Design — 99  
EV Solar Products — 99  
Evergreen Solar — 45  
Exeltech — 59  
Get a Job — 131  
Gorilla Vehicles — 115  
GreaseBaron.com — 105  
Greasecar Vegetable Fuel Systems — 85  
Great Northern Solar — 131  
Green Car Club — 86  
Guerrilla Solar T-shirts — 83  
Harris Hydroelectric — 84  
Heaven's Flame — 91  
Heliotrope Thermal — 111  
Hitney Solar Products — 119  
Home Power Back Issues — 121  
Home Power Biz Page — 81  
Home Power CD-ROMs — 48  
Home Power Solar1 CD-ROM — 68  
Home Power Solar7 CD-ROM — 97  
Home Power T-shirts — 80  
Home Power Web Site — 80  
Hydro Coil — 118  
Hydrocap — 104  
Hydroscreen Co LLC — 105  
Illinois RE Fair — 86  
In the Dark? — 139  
Innovative Energy Systems Inc — 20  
Inverter Repair — 78  
Jack Rabbit Energy Systems — 97  
John Drake Services, Inc. — 111  
Kansas Wind Power — 104  
KTA Services Inc — 105  
Kyocera Solar Inc — OBC  
Light It Technologies — 49  
Matrix — 46  
Meridian Energy Systems — 85  
Monolithic Domes — 119  
Morningstar — 85  
MREA Workshops — 69  
Natural Light Tubular Skylights — 115  
Nautilus Water Turbines Inc — 90  
New England Solar Electric Inc — 104  
Northwest Energy Storage — 60, 79, 97  
Offline — 99  
Outback Power Systems — 47  
Positive Resources — 84  
Powderhorn Institute Workshop — 87  
Power from the People Video — 99  
PowerPod Corporation — 119  
Prudential California Realty — 79  
Quick Start Specials — 80  
Rae Storage Battery Company — 103  
Renewable Energy Videos — 84  
RightHand Engineering — 119  
Rolls Battery Engineering — 47  
RV Power Products — 21, 79  
San Juan College — 125  
Schott Applied Power Corp — IBC  
Shell Solar — 18  
Simmons — 130  
SMA America Inc — 4  
Snorkel Stove Company — 57  
Solar Converters — 121  
Solar Depot — IFC  
Solar Electric Inc — 61  
Solar Energy International — 34  
Solar Living Institute — 78  
Solar Pathfinder — 125  
Solar Village — 27  
Solar Wind Works — 49, 79  
SolarFest — 87  
Solatron — 121  
SolEnergy — 61  
SOLutions in Solar Electricity — 84  
SolWest Fair — 87  
Southwest Renewable Energy Fair — 87  
Southwest Solar — 125  
Southwest Windpower — 19  
Subscription/CD Special — 99  
Sun Electronics — 44, 58, 91, 97  
Sun Frost — 79  
Sun Pumps Inc — 67  
SunDanzer — 78  
SunEarth Inc — 78  
Sunelco — 60, 105, 118, 124  
SunWize — 91  
Surrette Battery — 44  
Survival Unlimited — 97  
Trojan — 59  
U.S. Battery — 5  
Umpqua Community College Energy Fair — 90  
UniRac — 103  
USA Solar — 111  
Veggie Van — 104  
Vermont Solar Engineering — 115  
Wattsun (Array Tech Inc) — 83  
Windstream Power Systems — 125  
Xantrex — 1  
Zane International — 119  
Zephyr Industries Inc — 118  
Zomeworks — 96

# Schott Applied Power Corporation's



## SunRoof™ RS

## SunRoof™ FS



### SunRoof™ RS

The most complete residential PV system designed for quick and easy installation at a great price, without giving up quality or reliability.

### SunRoof™ FS

The only freestanding flat roof system for commercial buildings that offers roof access, a 25-year warranty, and no roof penetrations or ballast.



*Complete systems*

*Quick installation*

*Practical and affordable power*

*Sized to meet your energy needs*

Schott Applied Power Corporation  
Call: 1-800-344-2003  
or 1-888-457-6527  
[www.schottappliedpower.com](http://www.schottappliedpower.com)

**SCHOTT**  
glass made of ideas

# Kyocera Solar Direct

**Why buy from a distributor when you  
can buy from the MANUFACTURER?**

Now Accepting Dealer Applications

10th Edition  
Solar Electric Products Catalog  
Call for more information  
888-567-4921

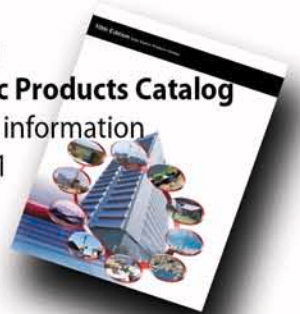

**NEW!**

## Dealer Support includes:

- Manufacturing
- Large Inventory
- Training Services
- Marketing Support
- Components/Systems
- Integration
- Test Facilities
- Project Management
- Co-Op Advertising
- 24 hour Workstation
- Engineering
- Field Services
- Technical Support
- Custom Modules
- Lead Referrals

*Partnership to Empower Your Business*

Kyocera Solar, Inc. Headquarters  
7812 E. Acoma Dr.  
Scottsdale, AZ 85260  
tel: 800-544-6466 / 480-948-8003  
fax: 800-523-2329 / 480-483-6431  
info@kyocerasolar.com  
www.kyocerasolar.com



**KYOCERA SOLAR, INC.**

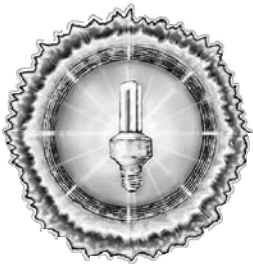

# Home Power Subscription

\$22.50 per year (6 issues) to U.S. Zip Codes via Publishers Periodical U.S. Mail  
 \$43.00 per year (6 issues) to U.S. Zip Codes via 1<sup>st</sup> Class U.S. Mail  
 \$30.00 (US\$ drawn on U.S. Bank) International Surface Mail, see pg. 81 for Air Rates  
**Home Power magazine, PO Box 520, Ashland, OR 97520**  
**Subscribe online at: [www.homepower.com](http://www.homepower.com)**  
**Subscriptions: 800-707-6585 (inside USA) or 541-512-0201 or Fax 541-512-0343**

To subscribe, please fill out the sub form below, enclose payment as a check, money order, or credit card information, and mail this form. Tape the form well or use an envelope so your check won't fall out. Please allow up to ten weeks for the start of your 2nd class sub. For **International Subscriptions or Back Issues of Home Power, please see page 81.**

- New Publishers Periodical Sub-\$22.50 to USA     New 1st Class Sub-\$43 to USA     Sub Renewal-**Circle** 1st Class or Publishers Periodical     Change of Address (include old address)
- Gift Subscription  
 From (your name and address here) \_\_\_\_\_

### DO YOU WANT US TO SEND YOU A SUBSCRIPTION RENEWAL NOTICE?

*The number of the last issue in your subscription is printed on your mailing label.*

- Yes, remind me by mail when my subscription runs out.     No, I'll check my mailing label so we can save energy & paper.

### PLEASE CLEARLY PRINT THE COMPLETE NAME AND ADDRESS FOR THIS SUBSCRIPTION:

NAME \_\_\_\_\_

STREET \_\_\_\_\_

CITY \_\_\_\_\_ STATE \_\_\_\_\_ ZIP \_\_\_\_\_

PHONE \_\_\_\_\_ EMAIL \_\_\_\_\_

- Credit Card Orders:** please check the type of card you have and fill in the information below.
- Signature (as shown on card) \_\_\_\_\_ Exp. Date \_\_\_\_\_
- Credit Card Number \_\_\_\_\_ Amount \$ \_\_\_\_\_
- 

The following information about your renewable energy usage helps us produce a magazine to better serve your interests. This information will be held confidential. We do not sell our mailing list. Completion of the rest of this form is not necessary to receive a subscription, but we would greatly appreciate your input.

**NOW:** I use renewable energy for (check ones that best describe your situation)

- All electricity
- Most electricity
- Some electricity
- Backup electricity
- Recreational electricity (RVs, boats, camping)
- Vacation or second home electricity
- Transportation power (electric vehicles)
- Water heating
- Space heating
- Business electricity

**In The FUTURE:** I plan to use renewable energy for (check ones that best describe your situation)

- All electricity
- Most electricity
- Some electricity
- Backup electricity
- Recreational electricity (RVs, boats, camping)
- Vacation or second home electricity
- Transportation power (electric vehicles)
- Water heating
- Space heating
- Business electricity

**RESOURCES:** My site(s) have the following renewable energy resources (check all that apply)

- Solar power
- Wind power
- Hydro power
- Biomass
- Geothermal power
- Tidal power
- Other renewable energy resource (explain)

**The GRID:** (check all that apply)

- I have the utility grid at my location.  
 I pay \_\_\_\_\_¢ for grid electricity (cents per kilowatt-hour).  
 \_\_\_\_\_% of my total electricity is purchased from the grid.
- I sell my excess electricity to the grid.  
 The grid pays me \_\_\_\_\_¢ for electricity (cents per kilowatt-hour).

(continued on reverse)

I now use, or plan to use in the future, the following renewable energy equipment (check all that apply):

NOW	FUTURE		NOW	FUTURE	
<input type="checkbox"/>	<input type="checkbox"/>	Photovoltaic modules	<input type="checkbox"/>	<input type="checkbox"/>	Methane digester
<input type="checkbox"/>	<input type="checkbox"/>	Wind generator	<input type="checkbox"/>	<input type="checkbox"/>	Thermoelectric generator
<input type="checkbox"/>	<input type="checkbox"/>	Hydroelectric generator	<input type="checkbox"/>	<input type="checkbox"/>	Solar oven or cooker
<input type="checkbox"/>	<input type="checkbox"/>	Battery charger	<input type="checkbox"/>	<input type="checkbox"/>	Solar water heater
<input type="checkbox"/>	<input type="checkbox"/>	Instrumentation	<input type="checkbox"/>	<input type="checkbox"/>	Wood-fired water heater
<input type="checkbox"/>	<input type="checkbox"/>	Batteries	<input type="checkbox"/>	<input type="checkbox"/>	Solar space heating system
<input type="checkbox"/>	<input type="checkbox"/>	Inverter	<input type="checkbox"/>	<input type="checkbox"/>	Hydrogen cells (electrolyzers)
<input type="checkbox"/>	<input type="checkbox"/>	Controls	<input type="checkbox"/>	<input type="checkbox"/>	Fuel cells
<input type="checkbox"/>	<input type="checkbox"/>	PV tracker	<input type="checkbox"/>	<input type="checkbox"/>	RE-powered water pump
<input type="checkbox"/>	<input type="checkbox"/>	Engine/generator	<input type="checkbox"/>	<input type="checkbox"/>	Electric vehicle

← FOLD HERE AND TAPE EDGES →

Please write to us here. Tell us what you like and don't like about Home Power. Tell us what you would like to read about in future issues. Thanks for your attention and support.

Check here  if it is OK to print your comments as a letter to Home Power.

← FOLD HERE AND TAPE EDGES →

Return Address

---

---

---

PLACE  
FIRST  
CLASS  
POSTAGE  
HERE

**Home Power magazine**  
**Post Office Box 520**  
**Ashland, OR 97520**